

Contents

1 MASTER TOOL SETS 1

- Modular Foam Kits
- Sets Building

2 TOOLS STORAGE 27

- Roll Cabinets
- Top Chests
- End Cabinets & Lockers
- Accessories
- Roll Carts
- Tool Boxes / Tool Bags

3 RATCHETS, SOCKETS & ACCESSORIES 43

- 1/4"
- 3/8"
- 1/2"
- 3/4"
- 1"

4 TORQUE TOOLS 77

- Torque Wrench
- Adjustable
- Preset Click-Type
- Electronic Type
- Torque Testers
- Checkers

5 WRENCHES 87

- Combination
- Adjustable
- Box
- Double Open End
- Special Wrenches
- Ratchet Combination
- T Shaped
- T & L Hex / L Torx

6 PLIERS & CUTTERS 109

- Pliers Sets / Standard & Mini
- Cutters
- Miniature
- Locking
- Retaining Ring
- Circlip Standard
- Miniature & Special

7 SCREWDRIVERS & BITS 127

- Screwdrivers
- Bits

8 STRIKING & CUTTING TOOLS 137

- Hammers
- Punches & Chisels
- Scrapers
- Files
- Cutting Tools

9 POWER TOOLS 153

- Pneumatic Tools
- Impact Wrenches
- Drills / Ratchets
- Die Grinders
- Cut-off Tools
- Grinders / Cutting Tools
- Sanders & Finishing Tools
- Impact Screwdrivers
- Accessories

10 MEASURING & INSPECTION TOOLS 179

- Measuring
- Lighting
- Battery & Testing

11 INSULATED TOOLS 197

- Modular Foam Kits
- Set Buildings
- Ratchets, Sockets & Accessories
- Wrenches
- Pliers & Cutters
- Screwdrivers
- Cutting Tools

12 AUTOMOTIVE WORKSHOP TOOLS 203

- Pick-up Tools
- Creepers
- Safety Equipment
- Floor Jacks
- Bottle Jacks
- Engine Cranes
- Workbench
- Specialty Tools
- Riveters
- Extractors
- Grease Guns
- Spray Guns
- Bench Vise
- Pry Bars
- C-Clamps
- Welding
- Tap & Dies Tools
- Airconditioning Services
- Wheels & Tires
- Cooling & Oil Systems
- Steering & Brakes
- Engines
- Cleaning

13 AUTOMOTIVE WORKSHOP EQUIPMENT 241

- Wheel Aligners
- Wheel Balancers
- Tyre Changers
- Scissor-on-Scissor Lifts
- 2-Post Lifts

MASTER TOOL SETS

Mobility, Portability & Organization



Blue-Point[®]





MASTER TOOL SETS

Modular Foam Kits

3/8" Drive Socket Set
Mobility, Portability & Organization

3



WARNING



• Do not use chrome or industrial finish hand tools with impact drivers
• Read safety precautions on page 220

1/4" Drive Socket Set

BPS10A

Packing: 1

CONTENTS	Set in modular foam kit
Sockets	4, 4.5, 5, 5.5, 6, 7, 8, 9, 10, 11, 12, 13 mm
Long Sockets	4, 5, 6, 7, 8, 9, 10, 11, 12, 13, 14 mm
Hex Socket Drivers	3, 4, 5, 6, 7, 8 mm
Flat Socket Drivers	4, 5.5, 6.5 mm
Phillips® Socket Drivers	#1, #2, #3
Pozidriv® Socket Drivers	#1, #2, #3
Torx® Socket Drivers	T8, T10, T15, T20, T25, T27, T30, T40
Quick Release Ratchet	1 pc.
Spinner Handle	1 pc.
Extension	2", 4"
Sliding T-handle	4.5"
Universal Joint	1 pc.
Flexible Extension	6"
Hex Bit Holder	1/4" Hex
Adaptor	1/4" * 3/8"



3/8" Drive Socket Set

BPS11A

Packing: 1

CONTENTS	Set in modular foam kit
Sockets	6, 7, 8, 9, 10, 11, 12, 13, 14, 15, 16, 17, 18, 19, 20, 21, 22, 23, 24 mm
Long Sockets	10, 11, 12, 13, 14, 15, 16, 17, 18, 19 mm
Quick Release Ratchet	1 pc.
Spark Plug Sockets	16, 21 mm
Sliding T-handle	6"
Adaptor	3/8" * 1/4"
Universal Joint	1 pc.
Locking Extension	3"



1/2" Drive Socket Set

BPS12A

Packing: 1

CONTENTS	Set in modular foam kit
Sockets	10, 11, 12, 13, 14, 15, 16, 17, 18, 19, 21, 22, 24, 27, 30, 32, 34 mm
Long Sockets	10, 13, 17, 19, 22 mm
Quick Release Ratchet	1 pc.
Sliding T-handle	10"
Universal Joint	1 pc.
Locking Extension	6"



Impact Socket Set

BPS13A

Packing: 1

CONTENTS	Set in modular foam kit
1/2" Impact Sockets	10, 11, 12, 13, 14, 15, 16, 17, 18, 19, 21, 22, 24, 27, 30, 32 mm
3/8" Impact Sockets	7, 8, 9, 10, 11, 12, 13, 14, 15, 16, 17, 18, 19 mm
Impact Extensions	3/8" Drive x 3", 1/2" Drive x 5"
Drive Adaptors	3/8"M * 1/4"F
Impact Adaptors	3/8"M * 1/2"F, 1/2"M * 3/8"F, 1/2"M * 3/4"F
Universal Joints	1/2" Drive



Combination Wrench Set

BPS4PA

Packing: 1

CONTENTS	Set in modular foam kit
Combination Wrenches	6, 7, 8, 9, 10, 11, 12, 13, 14, 15, 16, 17, 18, 19 mm



Large Combination Wrench Set

BPS19A

Packing: 1

CONTENTS	Set in modular foam kit
Combination Wrenches	20, 21, 22, 23, 24 mm



Adjustable Wrench Set

BPS6B

Packing: 1

CONTENTS	Set in modular foam kit
Adjustable Wrenches	8", 10"
Curved Jaw Locking Plier	7"
Straight Jaw Locking Plier	7"



**BPS6A - for China & India only



Adjustable Wrench & Pliers Set

BPS20A

Packing: 1

CONTENTS		Set in modular foam kit
Long Nose Plier	6"	
Combination Plier	8"	
Adjustable Wrenches	8", 12"	



45° Double Ring Wrench Set

BPS2A

Packing: 1

CONTENTS		Set in modular foam kit
45° Double Ring Wrenches	6x7, 8x9, 10x11, 12x13, 14x15, 16x17, 18x19, 20x22, 21x23, 24x27 mm	



75° Double Ring Wrench Set

BPS3A

Packing: 1

CONTENTS		Set in modular foam kit
75° Double Ring Wrenches	6x7, 8x9, 10x11, 12x13, 14x15, 16x17, 18x19, 20x22, 21x23, 24x27 mm	



Double Open End Wrench Set

BPS1A

Packing: 1

CONTENTS		Set in modular foam kit
Double Open End Wrenches	6x7, 8x9, 10x11, 12x13, 14x15, 16x17, 18x19, 20x22, 21x23, 24x27, 30x32 mm	



Single Direction Combination Wrench Set

BPS15A

Packing: 1

CONTENTS		Set in modular foam kit
Ratchet Combination Wrenches	6, 7, 8, 9, 10, 11, 12, 13, 14, 15, 16, 17, 18, 19 mm	



Double Ring, Single Direction, Ratcheting Wrench

BPS25A

Packing: 1

CONTENTS		Set in modular foam kit
Ratcheting Wrenches, Double Ring	6×7, 8×9, 10×11, 12×13, 13×14, 14×17, 17×19, 18×19, 20×22, 22×24, 23×24 mm	



Ratcheting Combination Wrench Set

BPS5A

Packing: 1

CONTENTS		Set in modular foam kit
Ratcheting Combination Wrenches	6, 7, 8, 9, 10, 11, 12, 13, 14, 15, 16, 17, 18, 19 mm	



L-Shape Wrench Set

BPS14A

Packing: 1

CONTENTS		Set in modular foam kit
Ball Hex Keys Set	1.5, 2, 2.5, 3, 4, 5, 6, 8, 10 mm	
L-Shape Torx Wrench Set	T10, T15, T20, T25, T27, T30, T40, T45, T50	
L-Shape Hex Keys	12, 14, 17, 19 mm	



L-Shape Long Torx Wrench Set

BPS16A

Packing: 1

CONTENTS		Set in modular foam kit
Folding Hex Key Set	1.5, 2, 2.5, 3, 4, 5, 6, 8 mm	
Extra Long Arm Torx Key Set	T10, T15, T20, T25, T27, T30, T40, T45, T50	
Extra Long Ball End Hex Key Set	1.5, 2, 2.5, 3, 4, 5, 6, 8, 10 mm	



Standard Pliers Set

BPS7A

Packing: 1

CONTENTS		Set in modular foam kit
Needle Nose Plier	6"	
Diagonal Cutting Plier	6"	
Combination Plier	8"	
Slip Joint Plier	8"	



Pliers Set

BPS18A

Packing: 1

CONTENTS		Set in modular foam kit
Plastic Cutter	6"	
Combination Plier	6"	
Diagonal Plier	6"	
Long Nose Plier	6"	



VDE Pliers Set

BPS24A

Packing: 1

CONTENTS		Set in modular foam kit
VDE Nose Plier	6"	
VDE Diagonal Plier	6"	
VDE Stripping Plier	6"	
VDE Combination Plier	7"	
VDE Adjustable Joint Plier	10"	



Circlip Pliers Set

BPS8A

Packing: 1

CONTENTS		Set in modular foam kit
External Circlip Plier, Straight	7"	
External Circlip Plier, 90°	7"	
Internal Circlip Plier, Straight	7"	
Internal Circlip Plier, 90°	7"	



Screwdrivers Set

BPS9A

Packing: 1

CONTENTS		Set in modular foam kit
M Series Flat Tip	3.2x75, 5x100, 6x38, 6x150 mm	
M Series Phillips® Tip	0x75, 1x75, 2x38, 2x100, 3x150 mm	



Torx® M Series Screwdriver Set

BPS22A

Packing: 1

CONTENTS		Set in modular foam kit
Torx® M Series Screwdriver, 75mm	TX6, TX7, TX8, TX9	
Torx® M Series Screwdriver, 100mm	TX10, TX15, TX20, TX25	



Precision Screwdriver Set

BPS27A

Packing: 1

CONTENTS		Set in modular foam kit
Precision Screwdrivers, Phillips®	PH0, PH00, PH000	
Precision Screwdrivers, Torx®	T6, T8	
Precision Screwdrivers, Slotted	SL1.4, SL2, SL2.4, SL3	



VDE Screwdriver Set

BPS23A

Packing: 1

CONTENTS		Set in modular foam kit
VDE Phillips® Screwdrivers	0x60, 1x80, 2x100, 3x150	
VDE Slotted Screwdrivers	2.5x75, 4x100, 5.5x125, 6.5x150	



Pass-Through Screwdriver Set

BPS26A

Packing: 1

CONTENTS		Set in modular foam kit
Pass-Through Screwdrivers, Phillips®	PH2x100, PH2x150, PH3x150, PH3x200	
Pass-Through Screwdrivers, Slotted	SL6x100, SL6x150, SL8x150	



Hammers & Striking Tools Set

BPS21A

Packing: 1

CONTENTS		Set in modular foam kit
Punch & Chisel Set	5 pcs	
Ball Peen Hammer	8 oz	
Soft Face Hammer	300 mm	



File Set

BPS17A

Packing: 1

CONTENTS		Set in modular foam kit
Half Round Second Files	6", 8"	
Round Second Files	6", 8"	
Flat Second Files	6", 8"	



1/4", 3/8" & 1/2" Drive Automotive Tool Set, 150pcs

BLPATSCM150

Packing: 1

CONTENTS		Set in storage case
1/4" DRIVE:		
Standard Sockets	11 pcs.	4, 5, 5.5, 6, 7, 8, 9, 10, 11, 12, 13 mm
Long Sockets	9 pcs.	4, 5, 6, 7, 8, 9, 10, 11, 12 mm
Quick Release Ratchet	1 pc.	
Extension Bar	1 pc.	4"
Spinner Handle	1 pc.	
Universal Joint	1 pc.	
Bit Holder	1 pc.	
Tamper Resistant Torx® Socket Drivers	6 pcs.	T10, T15, T20, T25, T27, T30
Torx® Socket Drivers	7 pcs.	T10, T15, T20, T25, T27, T30, T40
3/8" DRIVE:		
Standard Sockets	12 pcs.	8, 9, 10, 11, 12, 13, 14, 15, 16, 17, 18, 19 mm
Long Sockets	10 pcs.	8, 9, 10, 11, 12, 13, 14, 15, 17, 19 mm
External Torx® Sockets	8 pcs.	E8, E10, E11, E12, E14, E16, E18, E20
Spark Plug Sockets	2 pcs.	16, 21 mm
Quick Release Ratchet	1 pc.	
Universal Joint	1 pc.	
Adaptor	1 pc.	3/8"F * 1/2"M
Extension Bars	2 pcs.	3", 6"
Flat Socket Drivers	3 pcs.	5.5, 6.5, 8 mm
Phillips® Socket Drivers	2 pcs.	#1, #2
Hex Socket Drivers	4 pcs.	3, 4, 5, 6 mm
Torx® Socket Drivers	7 pcs.	T10, T15, T20, T25, T27, T30, T40
1/2" DRIVE:		
Standard Sockets	11 pcs.	14, 17, 18, 19, 20, 21, 22, 24, 27, 30, 32 mm
Long Sockets	9 pcs.	12, 13, 14, 15, 17, 18, 19, 21, 22 mm
Impact Sockets	4 pcs.	17, 19, 21, 23 mm
Extension Bars	2 pcs.	5", 10"
Quick Release Ratchet	1 pc.	
Universal Joint	1 pc.	
3-Way Adaptor	1 pc.	3/8"F * 1/2"M
TOOLS:		
M Series Screwdrivers	2 pcs.	Phillips® #2×38mm, Slotted #6×38mm
Pass-Through Screwdrivers	2 pcs.	Phillips® #2×100mm, Slotted #6×100mm
Double Ring Ratcheting Wrenches	3 pcs.	8×10, 12×14, 17×19 mm
Combination Wrenches	12 pcs.	8, 9, 10, 11, 12, 13, 14, 15, 16, 17, 18, 19 mm
L-Shape Hex Keys Wrench Set	1 set	
Long Nose Plier	1 pc.	6"
Slip Joint Plier	1 pc.	8"



1/4", 3/8" & 1/2" Drive Socket & Tool Set, 128pcs

BLPATSCM128

Packing: 1

CONTENTS		Set in storage case
1/4" DRIVE:		
Standard Sockets 6-Point	10 pcs.	4 to 13 mm
Deep Sockets 6-Point	10 pcs.	4 to 13 mm
Flat Socket Drivers	3 pcs.	4, 5.5, 6.5 mm
Hex Socket Drivers	6 pcs.	3, 4, 5, 6, 7, 8 mm
Phillips® Socket Drivers	4 pcs.	#0, #1, #2, #3
Tamper Resistant Torx® Socket Drivers	7 pcs.	T10, T15, T20, T25, T27, T30, T40
Pozidriv® Socket Drivers	4 pcs.	#0, #1, #2, #3
Quick Release Ratchet Handle	1 pc.	
Spinner Handle	1 pc.	6"
Extension Bars	2 pcs.	38, 75 mm
Universal Joint	1 pc.	
Flexible Handle	1 pc.	6"
Bit Adaptor	1 pc.	1/4"F * 1/4"H
Hex Bit Sockets	5 pcs.	1/8", 5/32", 3/16", 7/32", 1/4"
Flat Bit Sockets	4 pcs.	7/32", 3/16", 1/4", 9/32"
Torx® Bit Sockets	8 pcs.	T8, T10, T15, T20, T25, T27, T30, T40
Bit Adaptor	1 pc.	
3/8" DRIVE:		
Standard Sockets 6-Point	10 pcs.	10 to 19 mm
Deep Sockets 12-Point	10 pcs.	10 to 19 mm
Quick Release Ratchet Handle	1 pc.	
Extension Bars	3 pcs.	75, 150, 250 mm
Flexible Handle	1 pc.	10"
Universal Joint	1 pc.	
Spark Plug Sockets 6-Point	2 pcs.	16, 21 mm
Adaptor	1 pc.	3/8"F * 1/4"M
Sliding Bar	1 pc.	8"
1/2" DRIVE:		
Standard Sockets 6-Point	6 pcs.	20, 21, 22, 24, 27, 32 mm
Impact Sockets 6-Point	8 pcs.	14, 15, 16, 17, 18, 19, 21, 22 mm
Quick Release Ratchet Handle	1 pc.	
Extension Bar	1 pc.	125 mm
Coupler	1 pc.	1/4"F * 1/4"H
TOOLS:		
Ratcheting Wrenches	4 pcs.	13, 14, 15, 17 mm
Hex Key Set	9 pcs.	1.5, 2, 2.5, 3, 4, 5, 6, 8, 10 mm



1/4", 3/8" & 1/2" Drive Automotive Tool Set, 120pcs

BLPATSCM120

Packing: 1

CONTENTS	Set in storage case
1/4" DRIVE:	
Standard Sockets	10 pcs. 4, 5, 6, 7, 8, 9, 10, 11, 12, 13 mm
Deep Sockets	4 pcs. 8, 9, 10, 12 mm
Ratchet	1 pc.
Spinner Handle	1 pc.
Extension Bar	1 pc. 3"
Coupler	1 pc. 1/4" F * 1/4" H
Universal Joint	1 pc.
Hex Bit Sockets	6 pcs. 3, 4, 5, 6, 7, 8 mm
Flat Bit Sockets	3 pcs. 4, 5.5, 6.5 mm
Phillips® Bit Sockets	3 pcs. #1, #2, #3
Pozidriv® Bit Sockets	2 pcs. #1, #2
Torx® Bit Sockets	7 pcs. TT10, TT15, TT20, TT25, TT27, TT30, TT40
3/8" DRIVE:	
Standard Sockets	10 pcs. 10, 11, 12, 13, 14, 15, 16, 17, 18, 19 mm
Deep Sockets 12-Point	4 pcs. 13, 14, 15, 17 mm
External Torx® Sockets	8 pcs. E8, E10, E11, E12, E14, E16, E18, E20
Ratchet	1 pc.
Extension Bars	2 pcs. 3", 6"
Spark Plug Sockets	2 pcs. 16, 21 mm
Universal Joint	1 pc.
Adaptor	1 pc. 3/8"F * 1/4"M
Sliding Handle	1 pc. 8"
1/2" DRIVE:	
Standard Sockets 6-Point	6 pcs. 20, 21, 22, 24, 27, 32 mm
Impact Sockets	4 pcs. 17, 19, 21, 23 mm
Ratchet	1 pc.
Extension Bars	2 pcs. 5", 10"
Universal Joint	1 pc.
Adaptor	1 pc. 1/2"F * 3/8"M
TOOLS:	
Adjustable 3-Claw Oil Wrench	1 pc.
Test Pen	1 pc.
Hex Key 9pcs Set	1 set
Bit Set	20 pcs.
Combination Wrenches	11 pcs. 8, 9, 10, 11, 12, 13, 14, 16, 17, 18, 19 mm
Socket for Air Cylinder	1 pc. T52



1/4", 3/8" & 1/2" Drive Socket & Wrench Set, 100pcs

BLPATSCM100

Packing: 1

CONTENTS		Set in storage case
1/4" DRIVE:		
Standard Sockets	10 pcs.	4, 5, 6, 7, 8, 9, 10, 11, 12, 13 mm
Deep Sockets	10 pcs.	4, 5, 6, 7, 8, 9, 10, 11, 12, 13 mm
Quick Release Ratchet Handle	1 pc.	
Spinner Handle	1 pc.	
Extension Bars	2 pcs.	1-1/2", 3"
Universal Joint	1 pc.	
Flexible Handle	1 pc.	6"
Hex Bit Sockets	6 pcs.	3, 4, 5, 6, 7, 8 mm
Flat Bit Sockets	3 pcs.	4, 5.5, 6.5 mm
Phillips® Bit Sockets	4 pcs.	#0, #1, #2, #3
Pozidriv® Bit Sockets	4 pcs.	#0, #1, #2, #3
Tamper Torx® Bit Sockets	7 pcs.	TT10, TT15, TT20, TT25, TT27, TT30, TT40
3/8" DRIVE:		
Standard Sockets 6-Point	10 pcs.	10, 11, 12, 13, 14, 15, 16, 17, 18, 19 mm
Deep Sockets 12-Point	10 pcs.	10, 11, 12, 13, 14, 15, 16, 17, 18, 19 mm
Quick Release Ratchet	1 pc.	
Spark Plug Sockets	2 pcs.	16, 21 mm
Extension Bars	3 pcs.	3", 6", 10"
Universal Joint	1 pc.	
Flexible Handle	1 pc.	10"
Adaptor	1 pc.	3/8"F * 1/4"M
Sliding T-Handle	1 pc.	8"
1/2" DRIVE:		
Standard Sockets 12-Point	6 pcs.	20, 21, 22, 24, 27, 32 mm
Impact Sockets 6-Point	8 pcs.	14, 15, 16, 17, 18, 19, 21, 22 mm
Ratchet Handle	1 pc.	
Extension Bar	1 pc.	5"
WRENCH:		
Ratcheting Wrenches	4 pcs.	13, 14, 15, 17 mm



1/4", 3/8" & 1/2" Drive Torx® Bit Socket Set, 43pcs

BLPTSSC43

Packing: 1

CONTENTS		Set in storage case
1/4" DRIVE:		
External Torx® Sockets	5 pcs.	E4, E5, E6, E7, E8
Tamper Resistant Torx® Socket Drivers	10 pcs.	T6 to T10, T15, T20, T25, T27, T30
Tamper Resistant Long Torx® Socket Drivers	10 pcs.	T6 to T10, T15, T20, T25, T27, T30
3/8" DRIVE:		
External Torx® Sockets	4 pcs.	E10, E12, E14, E16
Tamper Resistant Torx® Socket Drivers	3 pcs.	T40, T45, T50
Tamper Resistant Long Torx® Socket Drivers	3 pcs.	T40, T45, T50
1/2" DRIVE:		
External Torx® Sockets	4 pcs.	E18, E20, E22, E34
Tamper Resistant Torx® Socket Drivers	2 pcs.	T55, T60
Tamper Resistant Long Torx® Socket Drivers	2 pcs.	T55, T60



1/4" & 3/8" Drive Socket Set, 155pcs

BLPGSSC155

Packing: 1

CONTENTS		Set in storage case
1/4" DRIVE:		
Standard Sockets	10 pcs.	Fractional, 3/16" to 9/16"
	13 pcs.	Metric, 4 to 14 mm
Deep Sockets	10 pcs.	Fractional, 3/16" to 9/16"
	11 pcs.	Metric, 4 to 14 mm
1/4" Hex Bits With Bit Holders	20 pcs.	Assorted
Ratchet / Socket Accessories	5 pcs.	
Quick Release Ratchet	1 pc.	
3/8" DRIVE:		
Standard Sockets	13 pcs.	Fractional, 1/4" to 1"
	19 pcs.	Metric, 6 to 24 mm
Deep Sockets	11 pcs.	Fractional, 3/8" to 1"
	15 pcs.	Metric, 10 to 24 mm
External Torx® Sockets	11 pcs.	E4 to E20
Spark Plug Sockets	2 pcs.	5/8", 13/16"
Hex Socket Drivers	3 pcs.	Metric, 7, 8, 10 mm
Tamper Resistant Torx® Socket Drivers	4 pcs.	T40, T45, T50, T55
Ratchet / Socket Accessories	6 pcs.	
Quick Release Ratchet	1 pc.	
Spinner Handle	1 pc.	



1/4" & 1/2" Drive Socket & Tool Set, 78pcs

BLPGSSCM78

Packing: 1

CONTENTS		Set in storage case
1/4" DRIVE:		
Standard Sockets	12 pcs.	4, 4.5, 5, 5.5, 6, 7, 8, 9, 10, 11, 12, 13 mm
Quick Release Ratchet	1 pc.	
Spinner Handle	1 pc.	
Extension Bar	1 pc.	4"
Coupler	1 pc.	1/4"F * 1/4"H
1/2" DRIVE:		
Standard Sockets	21 pcs.	8 to 24, 27, 30, 32, 34 mm
Quick Release Ratchet	1 pc.	
Spark Plug Sockets	2 pcs.	16, 21 mm
Extension Bars	3 pcs.	3", 6", 10"
3-way Adaptor	1 pc.	3/8"F * 1/2"M
TOOLS:		
Hex Bit Sockets	4 pcs.	3, 4, 5, 6 mm
Phillips® Bit Sockets	4 pcs.	#0, #1, #2, #3
Square Bit Sockets	2 pcs.	S1, S2
Flat Bit Sockets	3 pcs.	4, 5, 5.5 mm
Torx® Bit Sockets	7 pcs.	T8, T10, T15, T20, T25, T27, T30
Combination Wrenches	10 pcs.	10, 11, 12, 13, 14, 15, 16, 17, 18, 19 mm
Side Cutter	1 pc.	7"
Long Nose Plier	1 pc.	6"
Slip Joint Plier	1 pc.	10"
Adjustable Wrench	1 pc.	8"



1/4" & 1/2" Drive Socket & Tool Set



1 Clean Layout
Divider with individual tool illustrations



5 Tough Molded Case



2 Specific Size
Indicated on tool case for each tool



3 Maximum Comfort
Rubberized handle with no gaps for comfort



4 Secure Lock
Prevents opening when dropped



1/4" Drive Automotive Tool Set, 38pcs

BLPATSCM38

Packing: 1

CONTENTS	Set in storage case
1/4" DRIVE:	
Standard Sockets	14 pcs. 3.5, 4, 4.5, 5, 5.5, 6, 7, 8, 9, 10, 11, 12, 13, 14 mm
Extension Bars	2 pcs. 2", 4"
Quick Release Ratchet	1 pc.
Spinner Handle	1 pc.
Universal Joint	1 pc.
Sliding T-Handle	1 pc.
Torx® Socket Drivers	6 pcs. T10, T15, T20, T25, T30, T40
Hex Socket Drivers	5 pcs. 3, 4, 5, 6, 8 mm
Phillips® Socket Drivers	2 pcs. #1, #2
Pozidrive® Socket Drivers	2 pcs. PZ1, PZ2
Flat Tip Socket Drivers	3 pcs. 4, 5.5, 6.5 mm



1/4" Drive Socket Set, 29pcs

BLPATSM1429

Packing: 1

CONTENTS	Set in storage case
1/4" DRIVE:	
Standard Sockets 6-Point.	13 pcs. 4, 4.5, 5, 5.5, 6, 7, 8, 9, 10, 11, 12, 13, 14 mm
Deep Sockets 6-Point.	11 pcs. 4, 5, 6, 7, 8, 9, 10, 11, 12, 13, 14 mm
Quick Release Ratchet	1 pc.
Spinner Handle	1 pc.
Extension Bars	2 pcs. 3", 6"
Universal Joint	1 pc.



1/4" Drive Socket Set, 62pcs

BLPGSS1462

Packing: 1

CONTENTS		Set in storage case
1/4" DRIVE:		
Standard Sockets	11 pcs. Fractional, 3/16" to 5/8" 11 pcs. Metric, 4 to 14 mm	
Deep Sockets	11 pcs. Fractional, 3/16" to 5/8" 11 pcs. Metric, 4 to 14 mm	
Bit Holder	1 pc.	
Hex Bits	4 pcs. 9/64", 3/16", 7/32", 1/4"	
Flat Tip Bits	3 pcs. 5/32", 3/16", 1/4"	
Phillips® Bits	2 pcs. #1, #2	
Ratchet / Socket Accessories	7 pcs.	
Ratchet	1 pc.	



1/4" Drive Socket Set, 51pcs

BLPGSS1451A

Packing: 1

CONTENTS		Set in storage case
1/4" DRIVE:		
Standard Sockets	10 pcs. Fractional, 3/16" to 9/16" 13 pcs. Metric, 4 to 14 mm	
Sockets 8-Point	3 pcs. Fractional, 1/4", 5/16", 3/8"	
Torx® Socket Drivers	6 pcs. T8 to T27	
Hex Socket Drivers	6 pcs. Fractional, 1/8" to 5/16"	
Flat Tip Socket Drivers	3 pcs. 5/32", 7/32", 9/32"	
Phillips® Socket Drivers	3 pcs. #0, #1, #2	
Ratchet / Socket Accessories	6 pcs.	
Ratchet	1 pc.	



1/4" Drive Socket Set, 46pcs

BLP1446SI

Packing: 1

CONTENTS		Set in storage case
1/4" DRIVE:		
Sockets 6-Point	13 pcs. 4, 4.5, 5, 5.5, 6, 7, 8, 9, 10, 11, 12, 13, 14 mm	
Bit Sockets	3 pcs. 4, 5.5, 7 mm	
Hex Bit Sockets	6 pcs. 3, 4, 5, 6, 7, 8 mm	
Hex Torx® Bit Sockets	7 pcs. T8, T10, T15, T20, T25, T30, T40	
Phillips® Bits	3 pcs. #1, #2, #3	
Pozidriv® Sockets	3 pcs. PZ1, PZ2, PZ3	
Ratchet Handle	1 pc.	
Extension Bars	2 pcs. 2", 4"	
Flexible Extension	1 pc. 150 mm	
Sliding T-Handle	1 pc.	
Universal Joint	1 pc.	
Spinner	1 pc.	
Hex Keys	4 pcs. 1.27, 1.5, 2, 2.5 mm	



1/4" Drive Socket Set, 27pcs

BLPGSS1427

Packing: 1

- Good for automotive and home use
- Range of deep and shallow sockets for common fastener applications
- Ratchet and Handle Driver both available for a variety of jobs

CONTENTS		Set in storage case
1/4" DRIVE:		
Shallow Sockets 6-Point	11 pcs. Fractional, 3/16" to 5/8"	
Deep Sockets 6-Point	11 pcs. Fractional, 3/16" to 9/16"	
Socket Adaptors / Extensions	3 pcs.	
Quick Release Ratchet	1 pc.	
Spinner Handle	1 pc.	



1/4" Drive SAE Socket Set, 22pcs

BLPGSS1422

Packing: 1

CONTENTS		Set in storage case
1/4" DRIVE:		
Standard Sockets 6-Point	11 pcs. 3/16", 7/32", 1/4", 9/32", 5/16", 11/32", 3/8", 7/16", 1/2", 9/16", 5/8"	
Deep Sockets 6-Point	11 pcs. 3/16", 7/32", 1/4", 9/32", 5/16", 11/32", 3/8", 7/16", 1/2", 9/16", 5/8"	



1/4" Drive Stubby Bit Socket Set, 40pcs

BLPBSS40

Packing: 1

CONTENTS		Set in storage case
1/4" DRIVE:		
Hex Drivers	10 pcs. Fractional 5/64", 3/32", 7/64", 1/8", 5/32", 3/16", 7/32", 1/4", 5/16", 3/8" 10 pcs. Metric 2, 2.5, 3, 4, 5, 6, 7, 8, 9, 10 mm	
Torx® Tamper Proof Drivers	10 pcs. TP8, TP10, TP15, TP20, TP25, TP27, TP30, TP40, TP45, TP50	
XZN Triple Square Drivers	6 pcs. XZN4, XZN5, XZN6, XZN8, XZN10, XZN12	
Phillips® Drivers	2 pcs. #1, #2	
Flat Tip Drivers	2 pcs. 1/4", 3/8"	



3/8" Drive Socket Set, 77pcs

BLPATSM3877

Packing: 1

CONTENTS	Set in storage case
3/8" DRIVE:	
Standard Sockets 6-Point	19 pcs. 6, 7, 8, 9, 10, 11, 12, 13, 14, 15, 16, 17, 18, 19, 20, 21, 22, 23, 24 mm
Deep Sockets 12-Point	19 pcs. 6, 7, 8, 9, 10, 11, 12, 13, 14, 15, 16, 17, 18, 19, 20, 21, 22, 23, 24 mm
External Torx® Sockets	11 pcs. E4, E5, E6, E7, E8, E10, E12, E14, E16, E18, E20
Hex Bit Sockets	4 pcs. 6, 7, 8, 10 mm
Phillips® Bit Sockets	2 pcs. #3, #4
Pozidrive® Bit Sockets	2 pcs. #3, #4
Tamper Torx® Bit Sockets	8 pcs. TT10, TT15, TT20, TT25, TT27, TT30, TT40, TT45
Quick Release Ratchet	1 pc.
Extension Bars	3 pcs. 3", 6", 10"
Spark Plug Sockets	2 pcs. 16, 21 mm
Universal Joint	1 pc.
Flexible Handle	1 pc. 10"
Adaptors	2 pcs. 3/8" F * 1/2" M, 3/8" F * 1/4" M
Spinner Handle	1 pc.
Sliding T-handle	1 pc. 8"



3/8" Drive Automotive Tool Set, 58pcs

BLPATSCM58

Packing: 1

CONTENTS	Set in storage case
3/8" DRIVE:	
Sockets	14 pcs. 6, 7, 8, 9, 10, 11, 12, 13, 14, 15, 16, 17, 18, 19 mm
Quick Release Ratchet	1 pc.
Universal Joint	1 pc.
TOOLS:	
Long Arm Hex Key Wrench Set	1 set
Combination Wrenches	10 pcs. 8, 10, 11, 12, 13, 14, 15, 16, 18, 19 mm
Ratcheting Combination Wrench	1 pc. 17 mm
Adjustable Wrench	1 pc. 8"
M Series Screwdrivers	3 pcs. Slotted, #6x38mm, #3.2x75mm, #5x10mm 4 pcs. Phillips®, #2x38mm, #0x75mm, #1x100mm, #2x150mm
Long Nose Plier	1 pc. 6"
Linesman Plier	1 pc. 8"
Snap Ring Plier Set	1 set
Measuring Tape	1 pc. 3 m
Blades Feeler Gauges, 20 pcs	1 pc. 0.02-1 mm
Stainless Steel Straight Ruler	1 pc. 150 mm
Fiberglass Ball Pein Hammer	1 pc. 16 oz
Pick Up Tool	1 pc. 380 mm
Utility Knife	1 pc. 18 mm
Compact Flashlight	1 pc.



3/8" Drive Socket Set, 24pcs

BLPATSM3824

Packing: 1

CONTENTS		Set in storage case
3/8" DRIVE:		
Standard Sockets 12-Point	10 pcs.	10, 11, 12, 13, 14, 15, 16, 17, 18, 19 mm
Deep Sockets 12-Point	10 pcs.	10, 11, 12, 13, 14, 15, 16, 17, 18, 19 mm
Quick Release Ratchet	1 pc.	
Extension Bar	1 pc.	3"
Spark Plug Sockets	2 pcs.	16, 21 mm



3/8" Drive Socket Set, 85pcs

BLPGSS3885

Packing: 1

CONTENTS		Set in storage case
3/8" DRIVE:		
Standard Sockets	13 pcs.	Fractional, 1/4" to 1"
	14 pcs.	Metric, 6 to 19 mm
Deep Sockets	13 pcs.	Fractional, 1/4" to 1"
	14 pcs.	Metric, 6 to 19 mm
External Torx® Sockets	11 pcs.	E4 to E20
Phillips® Socket Driver	1 pcs.	#3
Pozidriv® Socket Drivers	2 pcs.	#3, #4
Tamper Resistant Torx® Socket Drivers	8 pcs.	T10 to T45
Spark Plug Sockets	2 pcs.	5/8", 13/16"
Ratchet / Socket Accessories	4 pcs.	
Ratchet	1 pc.	
Breaker Bar	1 pc.	
Spinner Handle	1 pc.	



3/8" Drive Socket Set, 49pcs

BLPGSS3849

Packing: 1

CONTENTS		Set in storage case
3/8" DRIVE:		
Standard Sockets 6-Point	8 pcs. Fractional, 5/16" to 3/4" 14 pcs. Metric, 6 to 19 mm	
Deep Sockets 12-Point	8 pcs. Fractional, 5/16" to 3/4" 13 pcs. Metric, 7 to 19 mm	
Extension Bars	2 pcs. 3", 6"	
Universal Joint	1 pc.	
Adaptor	1 pc. 3/8"F * 1/4"M	
Ratchet	1 pc.	



3/8" Drive Socket & Wrench Set, 37pcs

BLPGSS3837

Packing: 1

CONTENTS		Set in storage case
3/8" DRIVE:		
Standard Sockets 6-Point	8 pcs. Fractional, 5/16" to 3/4" 14 pcs. Metric, 6 to 19 mm	
Double Open End Wrenches	4 pcs. Fractional, 5/16"-3/8", 7/16"-1/2", 9/16"-5/8", 11/16"-3/4" 5 pcs. Metric, 10-11, 12-13, 14-15, 16-17, 18-19 mm	
Extension Bars	2 pcs. 3", 6"	
Ratchet	1 pc.	
Universal Joint	1 pc.	
Adaptors	2 pcs. 1/4"F * 3/8"M, 3/8"F * 1/4"M	



Pass Thru Socket Set, 22pcs

BLPPTSS3822

Packing: 1

CONTENTS		Set in storage case
TOOLS:		
Sockets	BLPPTS38 thru BLPPTS34 (3/8" to 3/4")	
Metric Sockets	BLPPTSM8 thru BLPPTSM19 (8 to 19 mm)	
Pass Thru Adaptor	BLPPTA3438	
Extension Bars	BLPPTXT3	
Ratchet	BPRFPT10	



3/8" Drive Impact Socket Set, 13pcs

BLPATSIMM3813

Packing: 1

- Catered to Complement 3/8" Impact Wrenches
- Automotive and Two-Wheelers Workshops
- Compact Set with Only Commonly Used Sizes
- Complements existing BLPATSIMM1215 (1/2")

CONTENTS		Set in storage case
3/8" DRIVE:		
Shallow Impact Sockets	13 pcs.	7, 8, 9, 10, 11, 12, 13, 14, 15, 16, 17, 18, 19 mm



1/2" Drive Socket Set, 32pcs

BLPATSM1232

Packing: 1

- For Automotive and General Fastener Tightening Jobs
- Improves on existing BLPATSM1225
- Includes smaller sizes 8, 9 & 23 mm sockets
- Additional range of 12-points sockets
- Universal Joint Added for more Applications

CONTENTS		Set in storage case
1/2" DRIVE:		
Sockets 6-Point	20 pcs.	8, 9, 10, 11, 12, 13, 14, 15, 16, 17, 18, 19, 20, 21, 22, 23, 24, 27, 30, 32 mm
Sockets 12-Point	7 pcs.	8, 10, 12, 13, 14, 17, 19 mm
Ratchet	1 pc.	
Extension Bars	2 pcs.	5", 10"
Universal Joint	1 pc.	
Sliding Adaptor	1 pc.	1/2"F * 3/8"M



1/2" Drive Socket Set, 25pcs

BLP1225SI

Packing: 1

CONTENTS		Set in storage case
1/2" DRIVE:		
Sockets 6-Point	18 pcs.	8 to 22, 24, 27, 30, 32 mm
Spark Plug Sockets	2 pcs.	16, 21 mm
Ratchet Handle	1 pc.	
Extension Bars	2 pcs.	5", 10"
Sliding T-Handle	1 pc.	
Universal Joint	1 pc.	



1/2" Drive Socket Set, 25pcs

BLPATSM1225

Packing: 1

CONTENTS		Set in storage case
1/2" DRIVE:		
Sockets 6-Point	19 pcs.	10, 11, 12, 13, 14, 15, 16, 17, 18, 19, 20, 21, 22, 24, 27, 30, 32, 34, 36 mm
Quick Release Ratchet	1 pc.	
Extension Bars	2 pcs.	5", 10"
3-way Adaptor	1 pc.	3/8" F * 1/2" M
Spark Plug Sockets	2 pcs.	16, 21 mm



1/2" Drive Socket Set, 33pcs

BLPGSS1233

Packing: 1

CONTENTS		Set in storage case
1/2" DRIVE:		
Standard Sockets	15 pcs.	Fractional, 3/8" to 1 1/4"
	12 pcs.	Metric, 12 to 24 mm
Breaker Bar	1 pc.	
Universal Joint	1 pc.	
Quick Release Ratchet	1 pc.	
Extension Bars	3 pcs.	3", 6", 10"



1/2" Drive Impact Socket Set, 15pcs

BLPATSIMM1215

Packing: 1

CONTENTS		Set in storage case
1/2" DRIVE:		
Impact Sockets 6-Point	14 pcs.	10, 11, 12, 13, 14, 15, 16, 17, 18, 19, 21, 22, 23, 24 mm
Impact Extension Bar	1 pc.	5"



Car Body Hammer Set, 7pcs

BPBHS7

Packing: 1

CONTENTS		Set in storage case
TOOLS:		
Bumping Hammer	1 pc.	
Pick and Finish Hammer	1 pc.	
Reverse Curve Hammer	1 pc.	
Curve Dolly	1 pc.	
Double End Dolly	1 pc.	
Shrinking Dolly	1 pc.	
Utility Dolly	1 pc.	



Automotive Tool Set, 11pcs

BLPGH11

Packing: 1

CONTENTS		Set in storage case
TOOLS:		
Adjustable Wrench	1 pc. 8"	
M Series Screwdriver, Slotted	1 pc. #5x100 mm	
M Series Screwdriver, Phillips®	1 pc. #1x100 mm	
Testing Pen	1 pc. 110 - 250V AC	
Needle Nose Plier	1 pc. 6"	
Combination Plier	1 pc. 7"	
Measuring Tape	1 pc. 3 m	
Steel Curved Claw Hammer	1 pc. 8 oz	
Utility Knife	1 pc.	
Mini Hacksaw	1 pc.	
Compact Flashlight	1 pc.	



TOOLS STORAGE

High Performance In Design & Quality That Lasts
New Choice Of Colors Available Now!



Blue-Point[®]



Roll Cab 8 Drawers



1 Double-Walled Construction
For rigidity.



2 High Performance Roller Bearing Railings
Railings withstanding 22.5kg per rail with roller bearings for smoother sliding of drawers.



3 Self-Lock Tabs
Lock & Roll mechanism to prevent drawers from sliding open.



4 Seamless Design
Cabinet doors edges are folded to form a seamless fit without gaps when closed; Cabinets walls reinforced with stiffeners to provide extra strength.

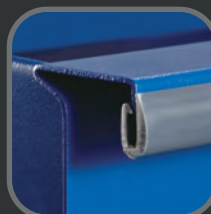

5 Double Hemmed Edges
Drawer edges are hemmed to double thickness for extra stiffness.



6 Heavy-Duty Construction
Reinforced base design to withstand higher overall load and reduce sagging.



7 Mobility
Large 5" castor wheels are bolt fastened for better rolling and durability.



6 Drawers, Classic Roll Cab, 26"

Packing: 1

- 26" full double walled construction making for a stronger box which resists the constant pounding of weight and vibration
- Stiffeners are added between the walls to reduce stress on the box and keep the drawers from sagging
- Welded lock tabs on the back of each drawer
- Casters fastened to roll cab using weld nuts to prevent loosening
- Drawer edges are hemmed to double thickness for extra stiffness



NEW! 7 Drawers, Classic Roll Cab, 40"

Packing: 1

- 40" full length drawers for larger tools storage
- 45kg max load capacity per drawer, providing a total load of 600kg
- 5" ball bearing casters for durability and easy maneuvering
- Self locking latch keeps drawers in place for safety and security
- Drawer edges are hemmed to double thickness for extra stiffness
- Available in matt colors upon request



PART NO.	COLORS	FINISH	DRAWERS	WIDTH (mm)	DEPTH (mm)	HEIGHT (mm)
KRB2006KPQP	Blue	Matt	6	660	503	965
KRB2006BLU	Blue	Gloss				
KRB2006KPQR	Red	Matt				
KRB2006RED	Red	Gloss				
KRB2006BLK	Black	Gloss				
KRB2006YEL	Yellow	Gloss				

CUBIC (cm ³)	NET WEIGHT (kg)	SHIPPING WEIGHT (kg)
156,791	75	95

SPECIFICATIONS	WIDTH (mm)	DEPTH (mm)	HEIGHT (mm)
Drawers	5	544	445
	1	544	445

PART NO.	COLORS	FINISH	DRAWERS	WIDTH (mm)	DEPTH (mm)	HEIGHT (mm)
KRB4007KPCM	Blue	Gloss	7	1016	501	961
KRB4007KPC	Black	Gloss				
KRB4007KPES	Yellow	Gloss				
KRB4007K	Red	Gloss				

CUBIC (cm ³)	NET WEIGHT (kg)	SHIPPING WEIGHT (kg)
250,771	125	133

SPECIFICATIONS	WIDTH (mm)	DEPTH (mm)	HEIGHT (mm)
Drawers	3	905	496
	3	905	496
	1	905	496



8 Drawers, Classic Roll Cab, 40"

Packing: 1

- 40" double bank roll cab, greater capacity
- Welded lock tabs on the back of each drawer
- Popular choice with side cabinet for your work center
- Full double walled construction making for a stronger box which resists the constant pounding of weight and vibration
- Stiffeners are added between the walls to reduce stress on the box and prevent the drawers from sagging



5 Drawers, L-Series Roll Cab, 26"

Packing: 1

- High grade steel plate with PE Powder painting for better flowing property to avoid peel
- Fully-openable drawers can withstand up to 45 kg weight
- Bigger sized with greater capacity at 508 kg
- Tubular lock-stronger over molded key lock
- Ribs added for enhanced strength to prevent cabinet deformation



PART NO.	COLORS	FINISH	DRAWERS	WIDTH (mm)	DEPTH (mm)	HEIGHT (mm)
KRB13008KPRB	Blue	Matt	8	1016	501	961
KRB13008BLU	Blue	Gloss				
KRB13008KPRR	Red	Matt				
KRB13008RED	Red	Gloss				
KRB13008BLK	Black	Gloss				
KRB13008YEL	Yellow	Gloss				

CUBIC (cm ³)	NET WEIGHT (kg)	SHIPPING WEIGHT (kg)
168,059	110	129

SPECIFICATIONS	WIDTH (mm)	DEPTH (mm)	HEIGHT (mm)
Drawers	5	543	445
	1	543	445
Cabinet Drawers	2	284	445

PART NO.	COLORS	FINISH	DRAWERS	WIDTH (mm)	DEPTH (mm)	HEIGHT (mm)
KRB13005KPRB	Blue	Matt	5	677	501	822
KRB13005BLU	Blue	Gloss				
KRB13005KPRR	Red	Matt				
KRB13005RED	Red	Gloss				
KRB13005BLK	Black	Gloss				
KRB13005YEL	Yellow	Gloss				

CUBIC (cm ³)	NET WEIGHT (kg)	SHIPPING WEIGHT (kg)
159,387	61	68

SPECIFICATIONS	WIDTH (mm)	DEPTH (mm)	HEIGHT (mm)
Drawers	1	543	445
	2	543	445
	2	543	445



6 Drawers, L-Series Roll Cab, 26"

Packing: 1

- High grade steel plate with PE Powder painting for better flowing property to avoid peel
- Fully-openable drawers can withstand up to 45 kg weight
- Bigger sized with greater capacity at 508 kg
- Tubular lock-stronger over molded key lock
- Ribs added for enhanced strength to prevent cabinet deformation



PART NO.	COLORS	FINISH	DRAWERS	WIDTH (mm)	DEPTH (mm)	HEIGHT (mm)
KRB13006KPRB	Blue	Matt	6	677	501	822
KRB13006BLU	Blue	Gloss				
KRB13006KPRR	Red	Matt				
KRB13006RED	Red	Gloss				
KRB13006BLK	Black	Gloss				
KRB13006YEL	Yellow	Gloss				

CUBIC (cm ³)	NET WEIGHT (kg)	SHIPPING WEIGHT (kg)
156,536	65	72

SPECIFICATIONS	WIDTH (mm)	DEPTH (mm)	HEIGHT (mm)
Drawers	3	543	445
	2	543	445
	1	543	445

7 Drawers, L-Series Roll Cab, 26"

Packing: 1

- High grade steel plate with PE Powder painting for better flowing property to avoid peel
- Fully-openable drawers can withstand up to 45 kg weight
- Bigger sized with greater capacity at 508 kg
- Tubular lock-stronger over molded key lock
- Ribs added for enhanced strength to prevent cabinet deformation



PART NO.	COLORS	FINISH	DRAWERS	WIDTH (mm)	DEPTH (mm)	HEIGHT (mm)
KRB13007KPRB	Blue	Matt	7	677	501	822
KRB13007BLU	Blue	Gloss				
KRB13007KPRR	Red	Matt				
KRB13007RED	Red	Gloss				
KRB13007BLK	Black	Gloss				
KRB13007YEL	Yellow	Gloss				

CUBIC (cm ³)	NET WEIGHT (kg)	SHIPPING WEIGHT (kg)
153,695	68	75

SPECIFICATIONS	WIDTH (mm)	DEPTH (mm)	HEIGHT (mm)
Drawers	5	543	445
	1	543	445
	1	543	445

NEW! 4 Drawers, Classic Top Chest, 26"

Packing: 1

- 45kg max Load capacity per drawer, provides a total load 180kg
- Drawers designed to fit in 3 Blue-Point modular sets in tandem
- Fits perfectly on the top of any Blue-Point 26" Roll Cabinets, providing users with additional tools storage solutions
- Drawer edges are hemmed to double thickness for extra stiffness



PART NO.	COLORS	FINISH	DRAWERS	WIDTH (mm)	DEPTH (mm)	HEIGHT (mm)
KRB2041PCM	Blue	Gloss	4	678	501	399
KRB2041PC	Black	Gloss				
KRB2041PES	Yellow	Gloss				
KRB2041K	Red	Gloss				

CUBIC (cm ³)	NET WEIGHT (kg)	SHIPPING WEIGHT (kg)
63,204	30	180

SPECIFICATIONS	WIDTH (mm)	DEPTH (mm)	HEIGHT (mm)
Drawers	2	566	496
	2	566	496

NEW! 4 Drawers, Classic Top Chest, 40"

Packing: 1

- 45kg max Load capacity per drawer, provides a total load 225kg
- Self locking latch keeps drawers in place for safety and security
- Perfect add-ons top for Blue-Point 40" Roll Cabinets
- Drawer edges are hemmed to double thickness for extra stiffness
- Includes sliver trim on drawers for a more professional look



PART NO.	COLORS	FINISH	DRAWERS	WIDTH (mm)	DEPTH (mm)	HEIGHT (mm)
KRB4041PCM	Blue	Gloss	4	1016	501	399
KRB4041PC	Black	Gloss				
KRB4041PES	Yellow	Gloss				
KRB4041K	Red	Gloss				

CUBIC (cm ³)	NET WEIGHT (kg)	SHIPPING WEIGHT (kg)
100,993	58	62

SPECIFICATIONS	WIDTH (mm)	DEPTH (mm)	HEIGHT (mm)
Drawers	2	904	496
	2	904	496

NEW! 4 Drawers, Classic Top Chest, 40"

Packing: 1

- 45kg max Load capacity per drawer, provides a total load 225kg
- Self locking latch keeps drawers in place for safety and security
- Perfect add-ons top for Blue-Point 40" Roll Cabinets
- Drawer edges are hemmed to double thickness for extra stiffness
- Includes sliver trim on drawers for a more professional look
- Lockable top lid



PART NO.	COLORS	FINISH	DRAWERS	WIDTH (mm)	DEPTH (mm)	HEIGHT (mm)
KRB4042PCM	Blue	Gloss	4	1016	501	497
KRB4042PC	Black	Gloss				
KRB4042PES	Yellow	Gloss				
KRB4042K	Red	Gloss				

CUBIC (cm ³)	NET WEIGHT (kg)	SHIPPING WEIGHT (kg)
158,731	71	86

SPECIFICATIONS	WIDTH (mm)	DEPTH (mm)	HEIGHT (mm)
Drawers	2	904	496
	2	904	496
Top Compartment	-	1014	475



5 Drawers, Classic Top Chest, 26"

- Can be placed on all Blue-Point roll cabinets as a top chest
- Side grooves for easy lifting
- Lockable top lid

Packing: 1

PART NO.	COLORS	FINISH	DRAWERS	WIDTH (mm)	DEPTH (mm)	HEIGHT (mm)
KRB2055KPQP	Blue	Gloss	5	660	374	437
KRB2055KPQR	Red	Gloss				
KRB2055KPC	Black	Gloss				
KRB2055KPES	Yellow	Gloss				
CUBIC (cm ³)		NET WEIGHT (kg)		SHIPPING WEIGHT (kg)		
72,824		38		44		
SPECIFICATIONS			WIDTH (mm)	DEPTH (mm)	HEIGHT (mm)	
Drawers	4	566	334	47		
	1	566	334	79		



NEW! 4 Drawers, L-Series Top Chest, 40"

Packing: 1

- 45kg max Load capacity per drawer, provides a total load 180kg
- Drawers designed to fit in 3 Blue-Point modular sets in tandem
- Fits perfectly on the top of any Blue-Point 26" Roll Cabinets, providing users with additional tools storage solutions
- Drawer edges are hemmed to double thickness for extra stiffness



PART NO.	COLORS	FINISH	DRAWERS	WIDTH (mm)	DEPTH (mm)	HEIGHT (mm)
KRB13004PCM	Blue	Gloss	4	678	501	419
KRB13004PC	Black	Gloss				
KRB13004PES	Yellow	Gloss				
KRB13004K	Red	Gloss				
KRB13004KPRO	Bahco Orange	Gloss				
CUBIC (cm ³)		NET WEIGHT (kg)		SHIPPING WEIGHT (kg)		
67,480		32		180		
SPECIFICATIONS			WIDTH (mm)	DEPTH (mm)	HEIGHT (mm)	
Drawers	3	566	496	62		
	1	566	496	127		

NEW! Side Cabinet KRB13003PCM

Packing: 1

- Easy fit to any Blue-Point roll cabinets
- Max load of 15 kg per drawer
- Corner gussets and double wall construction for improved stiffness and strength



PART NO.	COLORS	FINISH	DRAWERS	WIDTH (mm)	DEPTH (mm)	HEIGHT (mm)
KRB13003PCM	Blue	Gloss	-	419	503	821
CUBIC (cm ³)		NET WEIGHT (kg)		SHIPPING WEIGHT (kg)		
138,080		30		44		
SPECIFICATIONS			WIDTH (mm)	DEPTH (mm)	HEIGHT (mm)	
Shelves	2	383	496	-		

Pry Bar Box Document Holder Roll Cab Slots & Dots Side Panel



Magnetic Trays

Packing: 1

- Securely holds small parts and tools
- Magnetically attaches to any flat iron or steel surface
- Material: 430 Stainless Iron



MRB5A



MRB10A



MRB12A



MRB15A

PART NO.	DESCRIPTION	SIZES (mm)
MRB5A	Magnetic tray, Round	Round 152 diameter
MRB10A	Magnetic tray	250 x 140
MRB12A	Magnetic tray	355 x 140
MRB15A	Magnetic tray	290 x 265

Magnetic Rail

Packing: 1

- Provides easy access and organization of sockets and wrenches
- Extruded aluminum, high strength and corrosion resistant rail body
- High impact plastic socket holders which resists oil and grease
- 8 magnets with protective foam covering hold rail in place



PART NO.	CLIP SIZE (inches)	RAIL LENGTH (inches)
BLPSWR14	1/4	13
BLPSWR38	3/8	15
BLPSWR12	1/2	18 ⁷ / ₁₆



Roll Cab Tops

Packing: 1

- For use with all Blue-Point roll cabinets of respective sizes
- Available in two thickness, 660mm and 1016mm
- For KRB13008 models, only 1016mm can be used

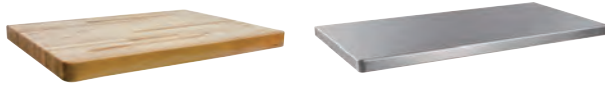

PART NO.	DESCRIPTION	THICKNESS
SKRWT4008	Wooden Top	660
SKRWT4008B	Wooden Top	1016
SKRSST4107	Stainless Steel Top	1016

Slots and Dots Side Panel

1470K-ACSIDE

Packing: 1

- Panel size 822 x 419 x 20mm
- Can be hung or screwed on the roll cab side wall
- Mix and match storage accessories
- 18 Steel Gauge thickness
- PE paint, PE texture



Foldable Tray

1470K-AC1

Packing: 1

- Folding tray
- 35 kg loading capacity
- 18 Steel Gauge thickness
- PE paint, PE texture



Can Holder

1470K-AC3

Packing: 1

- Storage tray, holds up to 6 cans
- 18 Steel Gauge thickness
- PE paint, PE texture



LED Light Top

Packing: 1

- Up to 15 hours continuous working or 3 months normal usage
- Available in 26" or 40"
- Each LED light set supply 72 lumens.
- 26" with 1 LED light on the middle front of the top
- 40" with 2 LED light on both side front of the top
- Run on 8 AAA batteries
- LED light will illuminate when movement is detected
- Lights cover every drawer
- Easy for locating small tools



PART NO.	WEIGHT (kg)	LENGTH (M)	WIDTH (M)	HEIGHT (M)
KLTOP26	12.2	0.68	0.51	0.042
KLTOP40	18.1	1.01	0.51	0.042

Pry Bar Box

1470K-AC2

Packing: 1

- Holds up to 23 pry bars or screwdrivers
- 18 Steel Gauge thickness
- PE paint, PE texture



Document Holder

1470K-AC4

Packing: 1

- 18 Steel Gauge thickness
- PE paint, PE texture





Heavy Duty Mini Cart

KRC1KPCM

Packing: 1

- Max capacity load of 50kg per tray, 150kg load capacity
- Compact size suitable for workshop usage
- Pre-drilled holes convenient to place tools on it



PART NO.	COLORS	FINISH	WIDTH (mm)	DEPTH (mm)	HEIGHT (mm)
KRC1KPCM	Blue	Gloss	400	501	960
CUBIC (cm ³)		NET WEIGHT (kg)		SHIPPING WEIGHT (kg)	
48,096		16		150	
SPECIFICATIONS		WIDTH (mm)	DEPTH (mm)	HEIGHT (mm)	
Trays		3	400	501	80

2 Shelves Roll Cart

KRBC2TCCPM

Packing: 1

- This model cart offers a more rugged construction
- Cart is also slightly larger than past models
- Trays feature rolled edges for improved strength and rigidity
- Maximum load capacity 68kg per tray
- Welded post holders
- Two locking casters



PART NO.	COLORS	WIDTH (mm)	DEPTH (mm)	HEIGHT (mm)	NET WEIGHT (kg)	LOAD CAPACITY (kg)
KRBC2TCCPM	Blue	756	428	920	17.2	159
KRBC2TC	Red					
SPECIFICATIONS		WIDTH (mm)	DEPTH (mm)	HEIGHT (mm)		
Trays		765	428	75		

Tool Storage Variety To Suit Every Need.



1 Drawer Roll Cart

KRBC3TDPCM

Packing: 1

- 4" deep locking drawer with tubular lock for added tool security
- Two sturdy, 3" deep trays are positioned for convenience
- Friction drawer slides
- Made of heavy-gauge steel



PART NO.	COLORS	WIDTH (mm)	DEPTH (mm)	HEIGHT (mm)	NET WEIGHT (kg)	LOAD CAPACITY (kg)
KRBC3TDPCM	Blue	813	452	920	29.5	136
KRBC3TD	Red					

SPECIFICATIONS		WIDTH (mm)	DEPTH (mm)	HEIGHT (mm)
Drawers	1	368	686	102
Trays	-	765	686	102

4 Drawers Flip-Top Roll Cart

KRBC7TDPCM

Packing: 1

- Latch System to unlock all 4 drawers once the top lid has been opened with a key
- Folding side work shelf provides extra work space
- Padded lid provides an additional work surface
- Locking prybar compartment securely holds all length prybars and screwdrivers



PART NO.	COLORS	DRAWERS	WIDTH (mm)	DEPTH (mm)	HEIGHT (mm)	NET WEIGHT (kg)
KRBC7TDPCM	Blue	4	869	431	1,041	56.2
KRBC7TD	Red					

SPECIFICATIONS		WIDTH (mm)	DEPTH (mm)	HEIGHT (mm)
Drawers	2	350	399	51
	1	700	391	51
	1	700	391	102
Bottom Shelf	1	700	391	76

2 Drawers Flip-Top Roll Cart

KRBC15TPCM

Packing: 1

- Padded lid protects finish and provides additional work surface
- Removable top chest locks to cart
- Two roller bearing slide drawers on both the top chest and cart
- EVA liners in all drawers and bottom compartment



PART NO.	COLORS	DRAWERS	WIDTH (mm)	DEPTH (mm)	HEIGHT (mm)
KRBC15TPCM	Blue	4	671	465	1,077
KRBC15T	Red				

NET WEIGHT (kg)	LOAD CAPACITY (kg)
40	136

SPECIFICATIONS		WIDTH (mm)	DEPTH (mm)	HEIGHT (mm)
Drawers	2	572	386	97
Trays	-	660	300	112
Bottom Shelf	1	667	456	331

4 Drawers Flip-Top Roll Cart

KRBC10TBPCM

Packing: 1

- Auto locking mechanism locks drawers when lid is closed
- Plated fasteners resist corrosion and self locking nuts assure a rigid, secure assembly
- Non-toxic mats in shelf, drawers and top compartment protect unit and keep tools from sliding



PART NO.	COLORS	DRAWERS	WIDTH (mm)	DEPTH (mm)	HEIGHT (mm)
KRBC10TBPCM	Blue	4	775	520	1,048
KRBC10TB	Red				

CUBIC (cm ³)	LOAD CAPACITY (kg)
121,700	245

SPECIFICATIONS	WIDTH (mm)	DEPTH (mm)	HEIGHT (mm)
Drawers	2	292	445
	1	622	445
	1	622	445
Top Compartment	-	762	483
Bottom Shelf	2	762	483

4 Drawers Sliding Top Roll Cart

KRBCSSTPCM

Packing: 1

- Padded lid protects finish and provides additional work surface
- Roller bearing slide drawers, locking slide top, internal prybar holder
- Dual locking casters keep cart in place during use



PART NO.	COLORS	DRAWERS	WIDTH (mm)	DEPTH (mm)	HEIGHT (mm)
KRBCSSTPCM	Blue	2	747	524	982
KRBCSST	Red				

CUBIC (cm ³)	NET WEIGHT (kg)	LOAD CAPACITY (kg)
261,062	56	136

SPECIFICATIONS	WIDTH (mm)	DEPTH (mm)	HEIGHT (mm)
Drawers	2	745	445
Top Compartment	-	747	524
Bottom Shelf	-	745	445

Hand Trolley

BLPHTB

Packing: 1

- High quality carbon steel and plastic material
- Telescopic handle for easy handling
- 3 individual boxes combine together
- Boxes are detachable for more variety of work
- Holds up to 45 kg of tools



PART NO.	WIDTH (mm)	DEPTH (mm)	HEIGHT (mm)
BLPHTB	520	320	720

SPECIFICATIONS	WIDTH (mm)	DEPTH (mm)	HEIGHT (mm)	WEIGHT (kg)
Top Drawer	430	200	150	3.5
Center Drawer	390	210	65	5.2
Bottom Drawer	400	215	275	5.8





Metal Tool Box, 19" Cantilever Style

Packing: 1

- 19" steel constructed cantilever tool box
- Durable and portable
- 5 trays design to accommodate more tools
- Full length steel handle



PART NO.	COLORS	Finish	WIDTH (mm)	DEPTH (mm)	HEIGHT (mm)
CTK19KPCM	Blue	Gloss	460	200	200
CTK19KPC	Black	Gloss			
CTK19KPES	Yellow	Gloss			
CTK19K	Red	Gloss			

CUBIC (cm ³)	NET WEIGHT (kg)	SHIPPING WEIGHT (kg)
17,131	4.6	35

SPECIFICATIONS	WIDTH (mm)	DEPTH (mm)	HEIGHT (mm)
Small Tray	4	460	99
Large Tray	1	460	97

Metal Tool Box

KRBK17 Packing: 1

- Portable steel tool box for users who prefer metal material over plastic
- High grade steel for greater strength & toughness
- PE powder painting for better protection against peel



PART NO.	LENGTH (mm)	WIDTH (mm)	HEIGHT (mm)
KRBK17	425	153	114

Mini Tool Box

BPKMTBB Packing: 1

- PE powder painting for better protection against peel
- Made of heavy gauge steel, tray thickness 0.9mm
- Perfect tools storage solution for ratchets and sockets



PART NO.	LENGTH (mm)	WIDTH (mm)	HEIGHT (mm)	WEIGHT (kg)
BPKMTBB	208	79.5	41	0.45

Metal Tool Box

KRBK24 Packing: 1

- Portable steel tool box for users who prefer metal material over plastic
- High grade steel for greater strength & toughness
- PE powder painting for better protection against peel
- Triple latch to prevent box from opening when dropped
- Additional internal metal tray for separating small tools



PART NO.	LENGTH (mm)	WIDTH (mm)	HEIGHT (mm)
KRBK24	511	199	195

Plastic Tool Boxes

Packing: 1

- Ideal for a wide range of storage needs
- Made of tough, injection molded plastic to ensure a precise fitting lid and durability
- Top carrying handle, tension latches, tote tray and padlock provision are also featured



YA482

YA484

PART NO.	SIZE (inches)	LENGTH (mm)	WIDTH (mm)	HEIGHT (mm)
YA482	16	419	210	165
YA484	23	587	260	267

Plastic Tool Boxes

Packing: 1

- Steel pins connecting the lid and box for extra durable usage
- Separate top tray to hold small tools
- Strong handle and lock material
- Large capacity 20" box, light weight and portable
- Made from shock resistant ABS and PP for durability and toughness
- Steel pins connecting the lid and box for extra durable usage
- Strong handle and lock material



BPBOX18

BPBOX20

PART NO.	SIZE (inches)	LENGTH (mm)	WIDTH (mm)	HEIGHT (mm)
BPBOX18	18	445	240	206
BPBOX20	20	558	277	270

Metal Tool Box, 18" Cantilever Style

KRW48C

Packing: 1

- Split top opening for tool access
- Cantilever trays on either side of cover, carrying handle

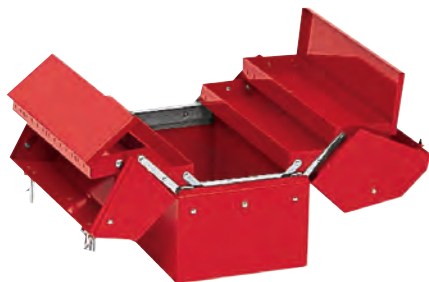

PART NO.	CUBIC (cm ³)	LENGTH (mm)	WIDTH (mm)	HEIGHT (mm)
KRW48C	25,070	457	254	337

Tote Bag, 17"

BPTOTE

Packing: 1

- Made of heavy duty 600x300D polyester, with Blue-Point embroidered logo
- Rugged, versatile, water resistant
- Wide top opening for easy access
- Multiple interior and external pockets for tool organization



PART NO.	SIZE (inches)	LENGTH (mm)	WIDTH (mm)	HEIGHT (mm)
BPTOTE	17	419	267	311





Backpack with Rigid Bottom

BLPBPACKH1

Packing: 1

- Dimension: L36 x W22 x H48 cm
- Bag weight: 1.95 kg
- Recommended load capacity: 16 kg
- Material: 600 Denier Polyester
- Thick, sturdy and durable material with water repellent finish
- Color: Tough black with blue/grey stripes



PART NO.	LENGTH (cm)	WIDTH (cm)	HEIGHT (cm)
BLPBPACKH1	36	22	48



Tool Bag, 17" Heavy Duty

BLPTBAG17

Packing: 1

- Dimension: L44.5 x W22 x H30.5 cm
- Recommended load capacity: 15 kg
- Constructed of heavy duty, water resistant material
- Ideal for carrying hand tools and other small to medium items
- Comfortable, cotton padded handles
- Rubber foam bottom keeps bag sturdy, protect contents from hard falls
- Designed to keep 3 modular sets in each bag



PART NO.	LENGTH (cm)	WIDTH (cm)	HEIGHT (cm)
BLPTBAG17	44.5	22	30.5



Backpack with Tools Holder

BLPBPACK2

Packing: 1

- Dimension: L31 x W18.5 x H48 cm
- Bag weight: 1.8 kg
- Recommended load capacity: 12 kg
- Material: 600 Denier Polyester
- Thick, sturdy and durable material with water repellent finish
- Color: Tough black with blue/grey stripes
- Comes with tools holder inside for more usage



PART NO.	LENGTH (cm)	WIDTH (cm)	HEIGHT (cm)
BLPBPACK2	31	18.5	48



Tool Bag with Metal Handle

BLPMOTB2

Packing: 1

- Dimension: L46 x W21 x H34 cm
- Recommended load capacity: 15 kg
- Wide open space below handle for easy access to tool carrier's main compartment
- Plastic reinforced internal pocket for utility knife or other tools
- Sturdy metal handle with molded foam grip for easy carrying
- Multi-use pockets to organize a wide range of tools and accessories



PART NO.	LENGTH (cm)	WIDTH (cm)	HEIGHT (cm)
BLPMOTB2	46	21	34

RATCHETS, SOCKETS & ACCESSORIES

All Sizes for Any Application

Blue-Point[®]

1/4" Quick Release Ratchet

BPRTR936

Packing: 1

- Features quick release button for rapid socket/accessory changes, even with greasy or oily hands
- Contoured handle for comfort and control
- Chrome finish for easy clean-up
- All ratchets in series meet or exceed ANSI B107-10M-1996 specifications



PART NO.	SQ. DRIVE (inches)	DESCRIPTION
BPRTR936	1/4	Standard Handle
GEAR TEETH	SWING ARC	A (mm)
36	10°	12
B (mm)	C (mm)	REPAIR KIT
25	143	RKRBPRTR936

1/4" Quick Release Ratchet, Soft Grip

BPRTR936SG

Packing: 1

- Features quick release button for rapid socket/accessory changes, even with greasy or oily hands
- Corrosive resistant bi-mold cushion grip for improved comfort and performance
- Chrome finish for easy clean-up
- All ratchets in series meet or exceed ANSI B107-10M-1996 specifications



PART NO.	SQ. DRIVE (inches)	DESCRIPTION
BPRTR936SG	1/4	Soft Grip Handle
GEAR TEETH	SWING ARC	A (mm)
36	10°	12
B (mm)	C (mm)	REPAIR KIT
25	143	RKRBPRTR936

1/4" Finger Ratchet

FSDR

Packing: 1

- Reversible, finger ratchet
- Small size works great for extremely tight areas
- Aluminum knurled outer ring for sure grip



PART NO.	SQ. DRIVE (inches)
FSDR	1/4 male - 1/4 female

1/4" Pass Thru Ratchet

BPRFPT10

Packing: 6

- Ratchet features a flex head design that allows for seven different locking positions



PART NO.	LENGTH (mm)
BPRFPT10	254



1/4" Socket, mm, 6-Point

- Manufactured from high grade steel alloy
- Features a Lifetime Warranty and exceeds ANSI Standards



Packing: 6

PART NO.	SIZE (mm)	LENGTH (mm)
BLPSM143.5	3.5	25
BLPSM144	4	
BLPSM144.5	4.5	
BLPSM145	5	
BLPSM145.5	5.5	
BLPSM146	6	
BLPSM147	7	
BLPSM148	8	
BLPSM149	9	
BLPSM1410	10	
BLPSM1411	11	
BLPSM1412	12	
BLPSM1413	13	
BLPSM1414	14	

1/4" Socket, mm, 12-Point

- Manufactured from high grade steel alloy
- Features a Lifetime Warranty and exceeds ANSI Standards

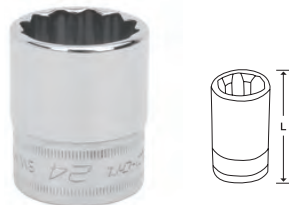

Packing: 6

PART NO.	SIZE (mm)	LENGTH (mm)
BLPDM144	4	24.8
BLPDM144.5	4.5	
BLPDM145	5	
BLPDM145.5	5.5	
BLPDM146	6	
BLPDM147	7	
BLPDM148	8	
BLPDM149	9	
BLPDM1410	10	
BLPDM1411	11	
BLPDM1412	12	
BLPDM1413	13	
BLPDM1414	14	

1/4" Socket, Inches, 6-Point

- Manufactured from high grade steel alloy
- Features a Lifetime Warranty and exceeds ANSI Standards



Packing: 6

PART NO.	SIZE (inches)	LENGTH (mm)
BLPS14532	5/32	25
BLPS14316	3/16	
BLPS14732	7/32	
BLPS1414	1/4	
BLPS14932	9/32	
BLPS14516	5/16	
BLPS141132	11/32	
BLPS1438	3/8	
BLPS14716	7/16	
BLPS1412	1/2	
BLPS14916	9/16	
BLPS1458	5/8	

1/4" Long Socket, mm, 6-Point

- Manufactured from high grade steel alloy
- Features a Lifetime Warranty and exceeds ANSI Standards



Packing: 6

PART NO.	SIZE (mm)	LENGTH (mm)
BLPLSM144	4	50
BLPLSM145	5	
BLPLSM146	6	
BLPLSM147	7	
BLPLSM148	8	
BLPLSM149	9	
BLPLSM1410	10	
BLPLSM1411	11	
BLPLSM1412	12	
BLPLSM1413	13	
BLPLSM1414	14	

1/4" Long Socket, Inches, 6-Point

Packing: 6

- Manufactured from high grade steel alloy
- Features a Lifetime Warranty and exceeds ANSI Standards



PART NO.	SIZE (inches)	LENGTH (mm)
BLPLS14316	3/16	50
BLPLS14732	7/32	
BLPLS1414	1/4	
BLPLS14932	9/32	
BLPLS14516	5/16	
BLPLS141132	11/32	
BLPLS1438	3/8	
BLPLS14716	7/16	
BLPLS1412	1/2	
BLPLS14916	9/16	
BLPLS1458	5/8	

1/4" Long Socket, mm, 12-Point

Packing: 6

- Manufactured from high grade steel alloy
- Features a Lifetime Warranty and exceeds ANSI Standards



PART NO.	SIZE (mm)	LENGTH (mm)
BLPLDM144	4	50
BLPLDM145	5	
BLPLDM146	6	
BLPLDM147	7	
BLPLDM148	8	
BLPLDM149	9	
BLPLDM1410	10	
BLPLDM1411	11	
BLPLDM1412	12	
BLPLDM1413	13	
BLPLDM1414	14	

1/4" Double Square Socket, 8-Point

Packing: 6

- Manufactured from high grade steel alloy
- Features a Lifetime Warranty and exceeds ANSI Standards



PART NO.	SIZE (inches)	LENGTH (mm)
BLPS81414	1/4	25
BLPS814516	5/16	
BLPS81438	3/8	

1/4" External Torx® Socket

Packing: 6

- Manufactured from high grade steel alloy
- Features a Lifetime Warranty and exceeds ANSI Standards



PART NO.	#	LENGTH (mm)
BLPTE144	E4	25
BLPTE145	E5	
BLPTE146	E6	
BLPTE147	E7	
BLPTE148	E8	



1/4" Torx® Bit Socket, Tamper Resistant

Packing: 1

- Manufactured from high grade steel alloy
- Features a Lifetime Warranty and exceeds ANSI Standards



PART NO.	#	A (inches)
BLPT146TP	T6	1 7/16
BLPT147TP	T7	
BLPT148TP	T8	
BLPT149TP	T9	
BLPT1410TP	T10	
BLPT1415TP	T15	
BLPT1420TP	T20	
BLPT1425TP	T25	
BLPT1427TP	T27	
BLPT1430TP	T30	

1/4" Torx® Bit Socket, Long, Tamper Resistant

Packing: 6

- Manufactured from high grade steel alloy
- Features a Lifetime Warranty and exceeds ANSI Standards

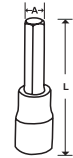

PART NO.	#	LENGTH (mm)
BLPTL146TP	T6	100
BLPTL147TP	T7	
BLPTL148TP	T8	
BLPTL149TP	T9	
BLPTL1410TP	T10	
BLPTL1415TP	T15	
BLPTL1420TP	T20	
BLPTL1425TP	T25	
BLPTL1427TP	T27	
BLPTL1430TP	T30	

1/4" Torx® Socket Driver

Packing: 6

- The BLPTS Series of Stubby Torx® socket drivers feature a reduced fastener depth penetration to increase strength and improve fastener engagement
- Manufactured from S2 Steel for longer tool life

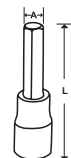

PART NO.	#	LENGTH (mm)
BLPTS0148	T8	19
BLPTS01410	T10	
BLPTS01415	T15	
BLPTS01420	T20	
BLPTS01425	T25	
BLPTS01427	T27	
BLPTS01430	T30	
BLPTS01440	T40	
BLPTS01445	T45	
BLPTS01447	T47	
BLPTS01450	T50	

1/4" Hex Socket Driver

Packing: 6

- The BLPHSM Series of Stubby Hex socket drivers feature a reduced fastener depth penetration to increase strength and improve fastener engagement
- Manufactured from S2 Steel for longer tool life

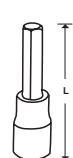

PART NO.	SIZE (mm)	LENGTH (mm)
BLPHSM0142	2	19
BLPHSM01425	2.5	
BLPHSM0143	3	
BLPHSM0144	4	
BLPHSM0145	5	
BLPHSM0146	6	
BLPHSM0147	7	
BLPHSM0148	8	
BLPHSM0149	9	
BLPHSM01410	10	

1/4" Hex Socket Driver, Tamper Resistant

Packing: 6

- The BLPTHSM Series of Stubby Hex Tamper Resistant socket drivers feature a reduced fastener depth penetration to increase strength and improve fastener engagement
- Manufactured from S2 Steel for longer tool life

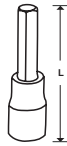

PART NO.	SIZE (mm)	LENGTH (mm)
BLPTHSM0142	2	19
BLPTHSM01425	2.5	
BLPTHSM0143	3	
BLPTHSM0144	4	
BLPTHSM0145	5	
BLPTHSM0146	6	
BLPTHSM0147	7	
BLPTHSM0148	8	
BLPTHSM0149	9	
BLPTHSM01410	10	

1/4" Phillips® Socket Driver

Packing: 6

- Manufactured from high grade steel alloy
- Features a Lifetime Warranty and exceeds ANSI Standards

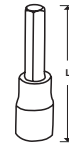

PART NO.	SIZE	LENGTH (mm)
BLPP140	#0	37
BLPP141	#1	
BLPP142	#2	
BLPP143	#3	
BLPP144	#4	

1/4" Phillips® Socket Driver, Stubby

Packing: 6

- Stubby Phillips® socket drivers feature a reduced fastener depth penetration to increase strength and improve fastener engagement
- Manufactured from S2 Steel for longer tool life

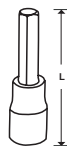

PART NO.	SIZE	LENGTH (mm)
BLPPS141	#1	19
BLPPS142	#2	

1/4" Pozidriv® Socket Driver

Packing: 6

- Manufactured from high grade steel alloy
- Features a Lifetime Warranty and exceeds ANSI Standards

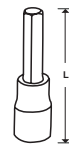

PART NO.	SIZE	LENGTH (mm)
BLPPD141	#1	37
BLPPD142	#2	
BLPPD143	#3	



1/4" Flat Tip Socket Driver, Short

- Manufactured from high grade steel alloy
- Features a Lifetime Warranty and exceeds ANSI Standards



Packing: 6

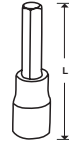

PART NO.	SIZE (inches)	LENGTH (mm)
BLPFS01414	1/4	19
BLPFS01438	3/8	

1/4" Triple Square Socket Driver

- Manufactured from high grade steel alloy
- Features a Lifetime Warranty and exceeds ANSI Standards

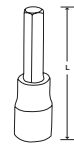

PART NO.	SIZE (mm)	LENGTH (mm)	
BLPXZN144	4	27	6
BLPXZN145	5		
BLPXZN146	6		
BLPXZN148	8		
BLPXZN1410	10	1	1
BLPXZN1412	12		

1/4" Sliding T-Handle, 4"

BLPSTHD144

Packing: 6

- Manufactured from high grade steel alloy
- Features a Lifetime Warranty and exceeds ANSI Standards

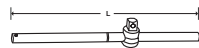

PART NO.	LENGTH (mm)
BLPSTHD144	114

1/4" Flat Tip Socket Driver, Standard

- Manufactured from high grade steel alloy
- Features a Lifetime Warranty and exceeds ANSI Standards



Packing: 6

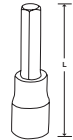

PART NO.	SIZE (inches)	SIZE (mm)	LENGTH (mm)
BLPFT144	5/32	4	37
BLPFT145.5	7/32	5.5	
BLPFT146.5	9/32	6.5	

1/4" Breaker Bar

BLPBB146

Packing: 6

- Manufactured from high grade steel alloy
- Features a Lifetime Warranty and exceeds ANSI Standards

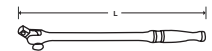

PART NO.	LENGTH (mm)
BLPBB146	152

1/4" Spinner Handle

BLPCGHD146

Packing: 6

- Manufactured from high grade steel alloy
- Features a Lifetime Warranty and exceeds ANSI Standards



PART NO.	LENGTH (mm)
BLPCGHD146	152

1/4" Extension, Knurled

Packing: 6

- Manufactured from high grade steel alloy
- Features a Lifetime Warranty and exceeds ANSI Standards



PART NO.	LENGTH (mm)
BLPTXK1.5	40
BLPTXK2	51
BLPTXK3	76
BLPTXK4	102
BLPTXK6	152

1/4" Flexible Extension

BLPEXTF146

Packing: 6

- Manufactured from high grade steel alloy
- Features a Lifetime Warranty and exceeds ANSI Standards

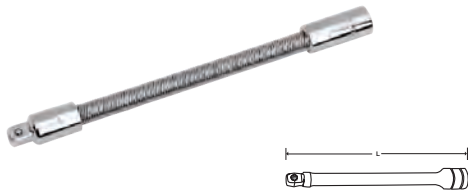

PART NO.	LENGTH (mm)
BLPEXTF146	152

1/4" Adaptor

BLPAFM1438

Packing: 6

- Manufactured from high grade steel alloy
- Features a Lifetime Warranty and exceeds ANSI Standards



PART NO.	INTERNAL SQ. DRIVE (inches)	EXTERNAL SQ. DRIVE (inches)
BLPAFM1438	1/4	3/8

1/4" Extension, Extra Long Locking

Packing: 6

- Smooth, durable chrome finish
- Made from tough 6130 steel
- Secure socket retention
- Lifetime warranty on individual extensions
- Do not use with power or impact tools



PART NO.	LENGTH (mm)
BLPEXTL1412	305
BLPEXTL1418	457
BLPEXTL1424	610

1/4" Universal Joint

BLPUJ14

Packing: 6

- Manufactured from high grade steel alloy
- Features a Lifetime Warranty and exceeds ANSI Standards



PART NO.	LENGTH (mm)
BLPUJ14	38

Spinner Adaptors

Packing: 1

- Ideal for getting into tight places while generating substantial torque
- Knurled nut body for positive grip
- Anodized knurled body design



PART NO.	SQ. DRIVE (inches)
FSD14	3/8 male - 1/4 female
FSD38	1/4 male - 3/8 female

1/4" Bit Holder

BLPTMBS1414

Packing: 6

- Manufactured from high grade steel alloy
- Features a Lifetime Warranty and exceeds ANSI Standards



PART NO.	LENGTH (mm)	DESCRIPTION
BLPTMBS1414	27	for 1/4" Hex Bits

1/4" Impact Adaptor

BLPAIM3814

Packing: 6

- Specially heat treated for impact use to provide long life, safety, and durability
- Suitable for use with pneumatic and electric impact wrenches
- Drive end features pin retention hole and groove



PART NO.	SIZE (inches)
BLPAIM3814	3/8 male x 1/4 female

1/4" Drive Fractional & Metric Impact Twist Socket Set

122TSTY

Packing: 1

- Constructed from heat treated alloy steel
- Industrial black finish
- One quarter millimeter increments between sizes which ensure coverage regardless of fastener head condition or manufacturer's tolerance
- Can be used with impact wrench



PART NO.	OD			
	SIZE	WRENCH END	DRIVE END	LENGTH inches (mm)
TSTY45	4.50mm	0.29 (7.4)	5.00 (127)	1.00 (25.4)
TSTY47	4.75mm & 3/16"	0.31 (7.9)		
TSTY50	5.00mm	0.32 (8.1)		
TSTY52	5.25mm	0.33 (8.4)		
TSTY55	5.50mm	0.34 (8.6)		
TSTY57	5.75mm	0.35 (8.9)		
TSTY60	6.00mm	0.37 (9.4)		
TSTY62	6.25mm & 1/4"	0.38 (9.7)		
TSTY65	6.50mm	0.39 (9.9)		
TSTY67	6.75mm	0.40 (10.2)		
TSTY70	7.00mm	0.41 (10.4)		

PART NO.	OD			
	SIZE	WRENCH END	DRIVE END	LENGTH inches (mm)
TSTY72	7.25mm & 9/32"	0.42 (10.7)	5.00 (127)	1.00 (25.4)
TSTY75	7.50mm	0.44 (11.2)		
TSTY77	7.75mm	0.45 (11.5)		
TSTY80	8.00mm & 5/16"	0.47 (11.8)		
TSTY82	8.25mm	0.48 (12.2)		
TSTY85	8.50mm	0.49 (12.6)		
TSTY87	8.75mm & 11/32"	0.51 (12.9)		
TSTY90	9.00mm	0.52 (13.2)		
TSTY92	9.25mm	0.54 (13.6)		
TSTY95	9.50mm & 3/8"	0.55 (14.0)		
TSTY100	10.00mm	0.57 (14.5)		

RATCHETS, SOCKETS & ACCESSORIES

1/4" Chrome Accessories / Impact Sockets & Accessories

3/8" Quick Release Ratchet



1 High-torque compact head design



2 High gear-teeth count for maximum work efficiency



3 Quick release to facilitate rapid socket changes



4 Chrome finish for easy clean-up



5 Contoured handle for comfort



3/8" Quick Release Ratchet

BPRFR938

Packing: 1

- Features quick release button for rapid socket/accessory changes, even with greasy or oily hands
- Contoured handle for comfort and control
- Chrome finish for easy clean-up
- All ratchets in series meet or exceed ANSI B107-10M-1996 specifications

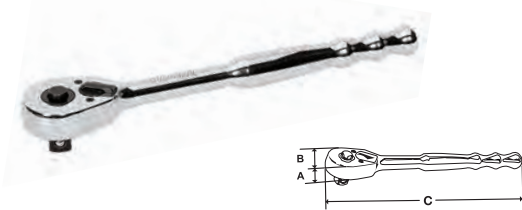

PART NO.	SQ. DRIVE (inches)	DESCRIPTION
BPRFR938	3/8	Standard Handle
GEAR TEETH	SWING ARC	A (mm)
38	9.5°	14
B (mm)	C (mm)	REPAIR KIT
33	197	RKRBPRFR938

3/8" Quick Release Ratchet, Soft Grip

BPRFR938SG

Packing: 1

- Features quick release button for rapid socket/accessory changes, even with greasy or oily hands
- Corrosive resistant bi-mold cushion grip for improved comfort and performance
- Chrome finish for easy clean-up
- All ratchets in series meet or exceed ANSI B107-10M-1996 specifications

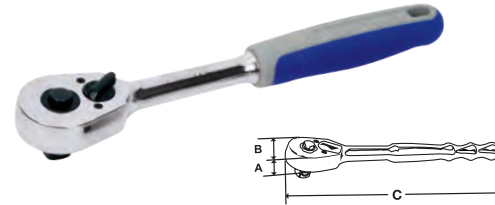

PART NO.	SQ. DRIVE (inches)	DESCRIPTION
BPRFR938SG	3/8	Soft Grip Handle
GEAR TEETH	SWING ARC	A (mm)
38	9.5°	14
B (mm)	C (mm)	REPAIR KIT
33	197	RKRBPRFR938

3/8" Pass Thru Ratchet

BPRFPT10

Packing: 6

- Ratchet features a flex head design that allows for seven different locking positions



PART NO.	LENGTH (mm)
BPRFPT10	254

3/8" Finger Ratchet

FSDR1

Packing: 1

- Reversible, finger ratchet
- Small size works great for extremely tight areas
- Aluminum knurled outer ring for sure grip



PART NO.	SQ. DRIVE (inches)
FSDR1	3/8 male - 1/4 female

3/8" Socket, mm, 6-Point

Packing: 6

- Manufactured from high grade steel alloy
- Features a Lifetime Warranty and exceeds ANSI Standards

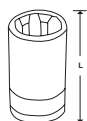

PART NO.	SIZE (mm)	LENGTH (mm)
BLPSM386	6	25.5
BLPSM387	7	
BLPSM388	8	
BLPSM389	9	
BLPSM3810	10	
BLPSM3811	11	27
BLPSM3812	12	
BLPSM3813	13	
BLPSM3814	14	
BLPSM3815	15	

PART NO.	SIZE (mm)	LENGTH (mm)
BLPSM3816	16	27
BLPSM3817	17	
BLPSM3818	18	
BLPSM3819	19	29
BLPSM3820	20	
BLPSM3821	21	
BLPSM3822	22	31
BLPSM3823	23	
BLPSM3824	24	

3/8" Socket, Inches, 6-Point

Packing: 6

- Manufactured from high grade steel alloy
- Features a Lifetime Warranty and exceeds ANSI Standards



PART NO.	SIZE (inches)	LENGTH (mm)
BLPS3814	1/4	25
BLPS38516	5/16	
BLPS3838	3/8	
BLPS38716	7/16	
BLPS3812	1/2	
BLPS38916	9/16	27
BLPS3858	5/8	
BLPS381116	11/16	
BLPS3834	3/4	29
BLPS381316	13/16	
BLPS3878	7/8	
BLPS381516	15/16	
BLPS381	1	

3/8" Socket, mm, 12-Point

Packing: 6

- Manufactured from high grade steel alloy
- Features a Lifetime Warranty and exceeds ANSI Standards



PART NO.	SIZE (mm)	LENGTH (mm)
BLPDM386	6	25.5
BLPDM387	7	
BLPDM388	8	
BLPDM389	9	
BLPDM3810	10	
BLPDM3811	11	27
BLPDM3812	12	
BLPDM3813	13	
BLPDM3814	14	
BLPDM3815	15	

PART NO.	SIZE (mm)	LENGTH (mm)
BLPDM3816	16	27
BLPDM3817	17	
BLPDM3818	18	
BLPDM3819	19	29
BLPDM3820	20	
BLPDM3821	21	
BLPDM3822	22	31
BLPDM3823	23	
BLPDM3824	24	

3/8" Long Socket, mm, 12-Point

Packing: 6

- Manufactured from high grade steel alloy
- Features a Lifetime Warranty and exceeds ANSI Standards



PART NO.	SIZE (mm)	LENGTH (mm)
BLPLM386	6	64
BLPLM387	7	
BLPLM388	8	
BLPLM389	9	
BLPLM3810	10	
BLPLM3811	11	
BLPLM3812	12	
BLPLM3813	13	
BLPLM3814	14	

PART NO.	SIZE (mm)	LENGTH (mm)
BLPLM3815	15	64
BLPLM3816	16	
BLPLM3817	17	
BLPLM3818	18	
BLPLM3819	19	
BLPLM3820	20	
BLPLM3821	21	
BLPLM3822	22	

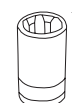

3/8" Socket



3/8" Long Socket, Inches, 12-Point

Packing: 6

- Manufactured from high grade steel alloy
- Features a Lifetime Warranty and exceeds ANSI Standards



PART NO.	SIZE (inches)	LENGTH (mm)
BLPL3814	1/4	64
BLPL38516	5/16	
BLPL3838	3/8	
BLPL38716	7/16	
BLPL3812	1/2	
BLPL38916	9/16	
BLPL3858	5/8	
BLPL381116	11/16	
BLPL3834	3/4	
BLPL381316	13/16	
BLPL3878	7/8	
BLPL381516	15/16	
BLPL381	1	

3/8" External Torx® Socket

Packing: 6

- Manufactured from high grade steel alloy
- Features a Lifetime Warranty and exceeds ANSI Standards



PART NO.	#	LENGTH (mm)
BLPTE384	E4	31
BLPTE385	E5	
BLPTE386	E6	
BLPTE387	E7	
BLPTE388	E8	
BLPTE3810	E10	
BLPTE3811	E11	
BLPTE3812	E12	
BLPTE3814	E14	
BLPTE3816	E16	
BLPTE3818	E18	
BLPTE3820	E20	

RATCHETS, SOCKETS & ACCESSORIES

3/8" Sockets

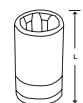

56

3/8" Torx® Bit Socket, Tamper Resistant

Packing: 1

- Manufactured from high grade steel alloy
- Features a Lifetime Warranty and exceeds ANSI Standards



PART NO.	#	A
BLPT3810TP	T10	1 27/32
BLPT3815TP	T15	
BLPT3820TP	T20	
BLPT3825TP	T25	
BLPT3827TP	T27	
BLPT3830TP	T30	
BLPT3840TP	T40	2
BLPT3845TP	T45	
BLPT3850TP	T50	
BLPT3855TP	T55	
BLPT3855TP	T55	

3/8" Torx® Bit Socket, Long, Tamper Resistant

Packing: 6

- Manufactured from high grade steel alloy
- Features a Lifetime Warranty and exceeds ANSI Standards



PART NO.	A	LENGTH (mm)
BLPTL3840TP	T40	110
BLPTL3845TP	T45	
BLPTL3850TP	T50	

3/8" Torx® Socket Driver

Packing: 6

- Manufactured from high grade steel alloy
- Features a Lifetime Warranty and exceeds ANSI Standards



PART NO.	#	LENGTH (mm)
BLPTS3810	T10	48
BLPTS3815	T15	
BLPTS3820	T20	
BLPTS3825	T25	
BLPTS3827	T27	
BLPTS3830	T30	
BLPTS3840	T40	51
BLPTS3845	T45	
BLPTS3850	T50	
BLPTS3855	T55	
BLPTS3855	T55	
BLPTS3860	T60	

3/8" Hex Socket Driver

Packing: 6

- Manufactured from high grade steel alloy
- Features a Lifetime Warranty and exceeds ANSI Standards



PART NO.	SIZE (mm)	LENGTH (mm)
BLPH383	3	47
BLPH384	4	
BLPH385	5	
BLPH386	6	
BLPH387	7	
BLPH388	8	50.5
BLPH3810	10	



3/8" Phillips® Socket Driver

Packing: 6

- Manufactured from high grade steel alloy
- Features a Lifetime Warranty and exceeds ANSI Standards

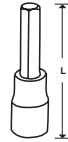

PART NO.	SIZE	LENGTH (mm)
BLPP381	#1	47
BLPP382	#2	
BLPP383	#3	
BLPP384	#4	

3/8" Pozidriv® Socket Driver

Packing: 6

- Manufactured from high grade steel alloy
- Features a Lifetime Warranty and exceeds ANSI Standards

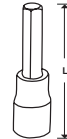

PART NO.	SIZE	LENGTH (mm)
BLPPD381	#1	47
BLPPD382	#2	
BLPPD383	#3	
BLPPD384	#4	

3/8" Triple Square Socket Driver

Packing: 6

- Manufactured from high grade steel alloy
- Features a Lifetime Warranty and exceeds ANSI Standards

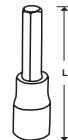

PART NO.	SIZE	LENGTH (mm)
BLPXZNM0384	M4	27
BLPXZNM0385	M5	
BLPXZNM0386	M6	
BLPXZNM0388	M8	
BLPXZNM03810	M10	
BLPXZNM03812	M12	

3/8" Flat Tip Socket Driver

Packing: 6

- Manufactured from high grade steel alloy
- Features a Lifetime Warranty and exceeds ANSI Standards

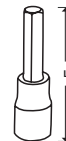

PART NO.	SIZE (mm)	LENGTH (mm)
BLPFT3855	5.5	47
BLPFT3865	6.5	
BLPFT388	8	

3/8" Breaker Bar

BLPBB3810

Packing: 6

- Manufactured from high grade steel alloy
- Features a Lifetime Warranty and exceeds ANSI Standards

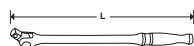

PART NO.	LENGTH (mm)
BLPBB3810	253

3/8" Sliding T-Handle

BLPSTHD388

Packing: 6

- Manufactured from high grade steel alloy
- Features a Lifetime Warranty and exceeds ANSI Standards

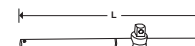

PART NO.	LENGTH (mm)
BLPSTHD388	197

3/8" Spinner Handle

BLPCGHD388

Packing: 6

- Manufactured from high grade steel alloy
- Features a Lifetime Warranty and exceeds ANSI Standards

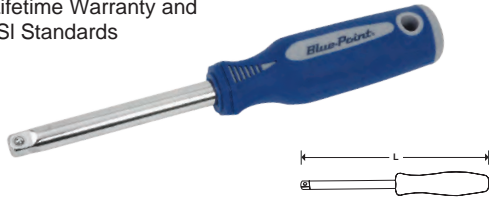

PART NO.	LENGTH (mm)
BLPCGHD388	219

3/8" Locking Extension

Packing: 6

- Smooth, durable chrome finish
- Made from tough 6130 steel
- Secure socket retention
- Lifetime warranty on individual extensions



PART NO.	LENGTH (mm)
FXLBP3	76
FXLBP6	152
FXLBP10	254

3/8" Pass Thru Socket, mm

Packing: 6

- Pass thru socket design avoids "bottoming out" on long fasteners and threaded rods
- Sockets can reach fasteners in tight spaces with relative ease



PART NO.	SIZE (mm)	LENGTH (mm)
BLPPTSM8	8	37
BLPPTSM9	9	
BLPPTSM10	10	
BLPPTSM11	11	
BLPPTSM12	12	
BLPPTSM13	13	
BLPPTSM14	14	
BLPPTSM15	15	
BLPPTSM16	16	
BLPPTSM17	17	
BLPPTSM18	18	
BLPPTSM19	19	

3/8" Extension, Knurled

Packing: 6

- Manufactured from high grade steel alloy
- Features a Lifetime Warranty and exceeds ANSI Standards

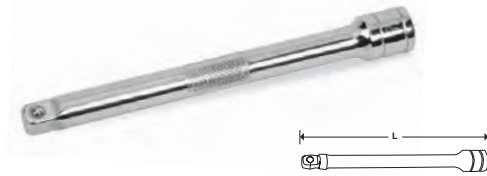

PART NO.	LENGTH (mm)
BLPEXTK383	75
BLPEXTK386	150
BLPEXTK3810	252

3/8" Locking Extension, Extra Long

Packing: 6

- Manufactured from high grade steel alloy
- Features a Lifetime Warranty and exceeds ANSI Standards



PART NO.	LENGTH (mm)
BLPEXTL3812	305
BLPEXTL3818	457
BLPEXTK3824	610

3/8" Pass Thru Socket, Inches

Packing: 6

- Pass thru socket design avoids "bottoming out" on long fasteners and threaded rods
- Sockets can reach fasteners in tight spaces with relative ease



PART NO.	SIZE (inches)	LENGTH (mm)
BLPPTS38	3/8	37
BLPPTS716	7/16	
BLPPTS12	1/2	
BLPPTS916	9/16	
BLPPTS58	5/8	
BLPPTS1116	11/16	
BLPPTS34	3/4	



3/8" Universal Joint

Manufactured from high-grade alloy steel
Offering same quality and features as our sockets with lifetime warranty

Flexible joint for more working angles



3/8" Pass Thru Extension

BLPPTEXT3

Packing: 6

- 3" extension

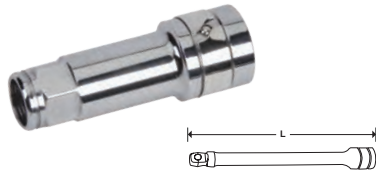

PART NO.	LENGTH (mm)
BLPPTEXT3	76

3/8" Bit Holder

BLPTMBS3814

Packing: 6

- Manufactured from high grade steel alloy
- Features a Lifetime Warranty and exceeds ANSI Standards



PART NO.	LENGTH (mm)	DESCRIPTION
BLPTMBS3814	19	For 1/4" Hex Bits

3/8" Universal Joint

BLPUJ38

Packing: 6

- Manufactured from high grade steel alloy
- Features a Lifetime Warranty and exceeds ANSI Standards

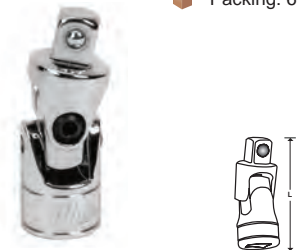

PART NO.	LENGTH (mm)
BLPUJ38	52

3/8" Adaptor

BLPAFM3814

Packing: 6

- Manufactured from high grade steel alloy
- Features a Lifetime Warranty and exceeds ANSI Standards



PART NO.	INTERNAL SQ. DRIVE (inches)	EXTERNAL SQ. DRIVE (inches)
BLPAFM3814	3/8	1/4
BLPAFM3812	3/8	1/2

3/8" Spinner Adaptor

FSD1

Packing: 1

- Ideal for getting into tight places while generating substantial torque
- Knurled nut body for positive grip
- Anodized body design.



PART NO.	SQ. DRIVE (inches)
FSD1	3/8 male - 3/8 female

3/8" Pass Thru Adaptor

BLPPTA3438

Packing: 6

- Manufactured from high grade steel alloy
- Features a Lifetime Warranty and exceeds ANSI Standards



PART NO.	LENGTH (mm)
BLPPTA3438	32

3/8" Impact Socket, Shallow, mm, 6-Point

Packing: 6

- Designed for maximum engagement on 6-point fasteners
- Suitable for use with pneumatic and electric impact wrenches
- Specially heat treated for impact use to provide long life, safety, and durability
- Drive end features pin retention hole and groove



PART NO.	SIZE (mm)
BLPSMIM387	7
BLPSMIM388	8
BLPSMIM389	9
BLPSMIM3810	10
BLPSMIM3811	11
BLPSMIM3812	12
BLPSMIM3813	13
BLPSMIM3814	14
BLPSMIM3815	15
BLPSMIM3816	16
BLPSMIM3817	17
BLPSMIM3818	18
BLPSMIM3819	19

3/8" Impact Socket, Shallow, Inches, 6-Point

Packing: 6

- Designed for maximum engagement on 6-point fasteners
- Suitable for use with pneumatic and electric impact wrenches
- Specially heat treated for impact use to provide long life, safety, and durability
- Drive end features pin retention hole and groove



PART NO.	SIZE (inches)
BLPSIM3814	1/4
BLPSIM38516	5/16
BLPSIM3838	3/8
BLPSIM38716	7/16
BLPSIM3812	1/2
BLPSIM38916	9/16
BLPSIM3858	5/8
BLPSIM381116	11/16
BLPSIM3834	3/4

3/8" Impact Socket, Deep, mm, 6-Point

Packing: 6

- Designed for maximum engagement on 6-point fasteners
- Suitable for use with pneumatic and electric impact wrenches
- Specially heat treated for impact use to provide long life, safety, and durability
- Drive end features pin retention hole and groove



PART NO.	SIZE (mm)
BLPLSMIM387	7
BLPLSMIM388	8
BLPLSMIM389	9
BLPLSMIM3810	10
BLPLSMIM3811	11
BLPLSMIM3812	12
BLPLSMIM3813	13

PART NO.	SIZE (mm)
BLPLSMIM3814	14
BLPLSMIM3815	15
BLPLSMIM3816	16
BLPLSMIM3817	17
BLPLSMIM3818	18
BLPLSMIM3819	19



3/8" Impact Socket, Deep, Inches, 6-Point

Packing: 6

- Designed for maximum engagement on 6-point fasteners
- Suitable for use with pneumatic and electric impact wrenches
- Specially heat treated for impact use to provide long life, safety, and durability
- Drive end features pin retention hole and groove



PART NO.	SIZE (inches)
BLPLSIM3814	1/4
BLPLSIM38516	5/16
BLPLSIM3838	3/8
BLPLSIM38716	7/16
BLPLSIM3812	1/2
BLPLSIM38916	9/16
BLPLSIM3858	5/8
BLPLSIM381116	11/16
BLPLSIM3834	3/4

3/8" Universal Joints

BLPJIM38

Packing: 6

- Specially heat treated for impact use to provide long life, safety, and durability
- Suitable for use with pneumatic and electric impact wrenches
- Drive end features pin retention hole and groove



PART NO.	SIZE (inches)
BLPJIM38	3/8 male x 3/8 female

3/8" Impact Adaptor

BLPAIM1238

Packing: 6

- Specially heat treated for impact use to provide long life, safety, and durability
- Suitable for use with pneumatic and electric impact wrenches
- Drive end features pin retention hole and groove



PART NO.	SIZE (inches)
BLPAIM1238	1/2 male x 3/8 female

3/8" Impact Socket, Extra Long, Inches, 6-Point

Packing: 6

- Extra length at 100 mm to reach two-wheelers transmission box screws
- Single piece construction
- For use on impact wrench without the need for extra extension



PART NO.	SIZE (inches)
BLPSMS8	8
BLPSMS10	10
BLPSMS12	12

3/8" Impact Swivel Socket

Packing: 10

- Laser welded pivot pin, means smooth, full 30° uninterrupted swivel action, which allows efficient power transfer prolonging the life of the socket
- Exceeds ANSI® performance standards
- 30° uninterrupted swivel action, means greater accessibility in tight quarters, which allows easier and faster removal of stubborn fasteners



PART NO.	SIZE (inches)	PART NO.	SIZE (inches)
BLPSS388	8	BLPSS3816	16
BLPSS389	9	BLPSS3817	17
BLPSS3810	10	BLPSS3818	18
BLPSS3811	11	BLPSS3819	19
BLPSS3812	12	BLPSS3820	20
BLPSS3813	13	BLPSS3821	21
BLPSS3814	14	BLPSS3822	22
BLPSS3815	15		

3/8" Extension

Packing: 6

- Specially heat treated for impact use to provide long life, safety, and durability
- Suitable for use with pneumatic and electric impact wrenches
- Drive end features pin retention hole and groove



PART NO.	SIZE (inches)
BLPEXIM383	3
BLPEXIM386	6

1/2" Quick Release Ratchet

BPRSR940

Packing: 1

- Features quick release button for rapid socket/accessory changes, even with greasy or oily hands
- Contoured handle for comfort and control
- Chrome finish for easy clean-up
- All ratchets in series meet or exceed ANSI B107-10M-1996 specifications

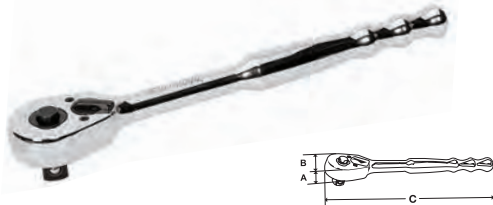

PART NO.	SQ. DRIVE (inches)	DESCRIPTION
BPRSR940	1/2	Standard Handle
GEAR TEETH	SWING ARC	A (mm)
40	9°	18
B (mm)	C (mm)	REPAIR KIT
44	251	RKRBPRSR940

1/2" Quick Release Ratchet, Soft Grip

BPRSR940SG

Packing: 1

- Features quick release button for rapid socket/accessory changes, even with greasy or oily hands
- Corrosive resistant bi-mold cushion grip for improved comfort and performance
- Chrome finish for easy clean-up
- All ratchets in series meet or exceed ANSI B107-10M-1996 specifications

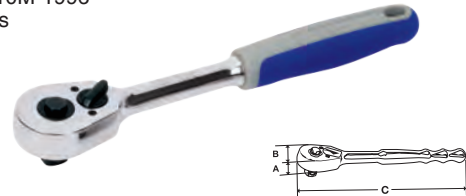

PART NO.	SQ. DRIVE (inches)	DESCRIPTION
BPRSR940SG	1/2	Soft Grip Handle
GEAR TEETH	SWING ARC	A (mm)
40	9°	18
B (mm)	C (mm)	REPAIR KIT
44	103	RKRBPRSR940

1/2" Socket, mm, 6-Point

Packing: 6

- Manufactured from high grade steel alloy
- Features a Lifetime Warranty and exceeds ANSI Standards



PART NO.	SIZE (mm)	LENGTH (mm)	PART NO.	SIZE (mm)	LENGTH (mm)
BLPSM128	8	38	BLPSM1219	19	38
BLPSM129	9		BLPSM1220	20	
BLPSM1210	10		BLPSM1221	21	
BLPSM1211	11		BLPSM1222	22	
BLPSM1212	12		BLPSM1223	23	
BLPSM1213	13		BLPSM1224	24	
BLPSM1214	14		BLPSM1227	27	
BLPSM1215	15		BLPSM1230	30	
BLPSM1216	16		BLPSM1232	32	
BLPSM1217	17		BLPSM1234	34	
BLPSM1218	18		BLPSM1236	36	

1/2" Socket, Inches, 6-Point

Packing: 6

- Manufactured from high grade steel alloy
- Features a Lifetime Warranty and exceeds ANSI Standards



PART NO.	SIZE (inches)	LENGTH (mm)	PART NO.	SIZE (inches)	LENGTH (mm)
BLPS12516	5/16	38	BLPS121316	13/16	38
BLPS1238	3/8		BLPS1278	7/8	
BLPS12716	7/16		BLPS121516	15/16	
BLPS1212	1/2		BLPS121	1	40
BLPS12916	9/16		BLPSB121116	1 1/16	
BLPS1258	5/8		BLPSB12118	1 1/8	
BLPS121116	11/16		BLPSB121316	1 3/16	
BLPS1234	3/4		BLPSB12114	1 1/4	



1/2" Socket, mm, 12-Point

Packing: 6

- Manufactured from high grade steel alloy
- Features a Lifetime Warranty and exceeds ANSI Standards



PART NO.	SIZE (mm)	LENGTH (mm)	
BLPDM128	8	38	
BLPDM129	9		
BLPDM1210	10		
BLPDM1211	11		
BLPDM1212	12		
BLPDM1213	13		
BLPDM1214	14		
BLPDM1215	15		
BLPDM1216	16		
BLPDM1217	17		
BLPDM1218	18		
BLPDM1219	19		
BLPDM1220	20		
BLPDM1221	21		
BLPDM1222	22		
BLPDM1223	23	41	
BLPDM1224	24		
BLPDM1225	25		
BLPDM1226	26	44	
BLPDM1227	27		
BLPDM1228	28		
BLPDM1229	29		
BLPDM1230	30		
BLPDM1231	31		
BLPDM1232	32		
BLPDM1234	34		
BLPDM1236	36		50

1/2" Socket, Inches, 12-Point

Packing: 6

- Manufactured from high grade steel alloy
- Features a Lifetime Warranty and exceeds ANSI Standards



PART NO.	SIZE (inches)	LENGTH (mm)
BLPD12516	5/16	38
BLPD1238	3/8	
BLPD12716	7/16	
BLPD1212	1/2	
BLPD12916	9/16	
BLPD1258	5/8	
BLPD121116	11/16	
BLPD1234	3/4	
BLPD121316	13/16	
BLPD1278	7/8	
BLPD121516	15/16	41
BLPD121	1	
BLPDB121116	1 1/16	44
BLPDB12118	1 1/8	
BLPDB12114	1 1/4	

RATCHETS, SOCKETS & ACCESSORIES

1/2" Ratchets / Sockets

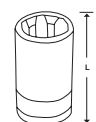

64

1/2" Long Socket, mm, 6-Point

Packing: 6

- Manufactured from high grade steel alloy
- Features a Lifetime Warranty and exceeds ANSI Standards



PART NO.	SIZE (mm)	LENGTH (mm)
BLPLM1210	10	76
BLPLM1211	11	
BLPLM1212	12	
BLPLM1213	13	
BLPLM1214	14	
BLPLM1215	15	
BLPLM1216	16	
BLPLM1217	17	
BLPLM1218	18	

PART NO.	SIZE (mm)	LENGTH (mm)
BLPLM1219	19	76
BLPLM1220	20	
BLPLM1221	21	
BLPLM1222	22	
BLPLM1224	24	
BLPLM1227	27	
BLPLM1230	30	
BLPLM1232	32	

1/2" Long Socket, Inches, 6-Point

Packing: 6

- Manufactured from high grade steel alloy
- Features a Lifetime Warranty and exceeds ANSI Standards



PART NO.	SIZE (inches)	LENGTH (mm)
BLPL1238	3/8	76
BLPL12716	7/16	
BLPL1212	1/2	
BLPL12916	9/16	
BLPL1258	5/8	
BLPL121116	11/16	
BLPL1234	3/4	

PART NO.	SIZE (inches)	LENGTH (mm)
BLPL121316	13/16	76
BLPL1278	7/8	
BLPL121516	15/16	
BLPL121	1	
BLPLB121116	1 1/16	
BLPLB12118	1 1/8	
BLPLB125114	1 1/4	

1/2" Long Socket, mm, 12-Point

Packing: 6

- Manufactured from high grade steel alloy
- Features a Lifetime Warranty and exceeds ANSI Standards



PART NO.	SIZE (mm)	LENGTH (mm)
BLPDLM129	9	77
BLPDLM1210	10	
BLPDLM1211	11	
BLPDLM1212	12	
BLPDLM1213	13	
BLPDLM1214	14	
BLPDLM1215	15	
BLPDLM1216	16	
BLPDLM1217	17	
BLPDLM1218	18	
BLPDLM1219	19	
BLPDLM1220	20	

PART NO.	SIZE (mm)	LENGTH (mm)
BLPDLM1221	21	77
BLPDLM1222	22	
BLPDLM1223	23	
BLPDLM1224	24	
BLPDLM1225	25	
BLPDLM1226	26	
BLPDLM1227	27	
BLPDLM1230	30	
BLPDLM1232	32	
BLPDLM1234	34	
BLPDLM1236	36	

1/2" External Torx® Socket

Packing: 6

- Manufactured from high grade steel alloy
- Features a Lifetime Warranty and exceeds ANSI Standards



PART NO.	#	LENGTH (mm)
BLPTE1210	E10	38
BLPTE1212	E12	
BLPTE1214	E14	
BLPTE1216	E16	
BLPTE1218	E18	
BLPTE1220	E20	
BLPTE1222	E22	
BLPTE1224	E24	

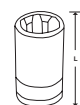

1/2" Torx® Bit Socket, Tamper Resistant

Packing: 1

- Manufactured from high grade steel alloy
- Features a Lifetime Warranty and exceeds ANSI Standards



PART NO.	#	A
BLPT1255TP	T55	2 5/16
BLPT1260TP	T60	2 5/16

1/2" Torx® Bit Socket, Long, Tamper Resistant

Packing: 6

- Manufactured from high grade steel alloy
- Features a Lifetime Warranty and exceeds ANSI Standards



PART NO.	#	LENGTH (mm)
BLPTL1255TP	T55	120
BLPTL1260TP	T60	

1/2" Torx® Socket Driver

Packing: 6

- Manufactured from high grade steel alloy
- Features a Lifetime Warranty and exceeds ANSI Standards



PART NO.	#	LENGTH (mm)
BLPT1220	T20	37
BLPT1225	T25	
BLPT1227	T27	
BLPT1230	T30	
BLPT1240	T40	
BLPT1245	T45	
BLPT1250	T50	
BLPT1255	T55	
BLPT1260	T60	

1/2" Torx® Socket Driver, Long

Packing: 6



PART NO.	#	LENGTH (mm)
BLPTL1220	T20	100
BLPTL1225	T25	
BLPTL1227	T27	
BLPTL1230	T30	
BLPTL1240	T40	
BLPTL1245	T45	
BLPTL1250	T50	
BLPTL1255	T55	
BLPTL1260	T60	

1/2" Hex Socket Driver

Packing: 6

- Manufactured from high grade steel alloy
- Features a Lifetime Warranty and exceeds ANSI Standards



PART NO.	SIZE (mm)	LENGTH (mm)	
BLPH123	3	36.5	
BLPH124	4		
BLPH125	5		
BLPH126	6		
BLPH127	7		
BLPH128	8		
BLPH1210	10		
BLPH1212	12		
BLPH1214	14		
BLPH1217	17		
BLPH1219	19		
BLPH125L180	5		180
BLPH126L70	6		70
BLPH126L140	6	140	
BLPH126L250	6	250	
BLPH128L120	8	120	
BLPH1210L140	10	140	

1/2" Hex Socket Driver, Long

Packing: 6

- Manufactured from high grade steel alloy
- Features a Lifetime Warranty and exceeds ANSI Standards

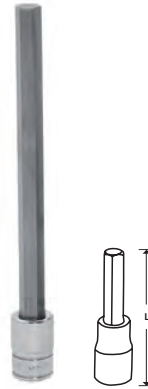

PART NO.	SIZE (mm)	LENGTH (mm)
BLPHL124	4	100
BLPHL125	5	
BLPHL126	6	
BLPHL127	7	
BLPHL128	8	
BLPHL1210	10	
BLPHL1212	12	
BLPHL1214	14	
BLPHL1217	17	

1/2" Breaker Bar

Packing: 6

- Manufactured from high grade steel alloy
- Features a Lifetime Warranty and exceeds ANSI Standards



PART NO.	LENGTH (mm)
BLPBB1210	254
BLPBB1215	381
BLPBB1224AP	605

1/2" Triple Square Socket Driver

Packing: 6

- Manufactured from high grade steel alloy
- Features a Lifetime Warranty and exceeds ANSI Standards



PART NO.	SIZE	LENGTH (mm)
BLPXZNM125	M5	37
BLPXZNM126	M6	
BLPXZNM128	M8	
BLPXZNM1210	M10	
BLPXZNM1212	M12	
BLPXZNM1214	M14	
BLPXZNM1216	M16	

1/2" Sliding T-Handle

BLPSTHD1215 Packing: 6

- Manufactured from high grade steel alloy
- Features a Lifetime Warranty and exceeds ANSI Standards



PART NO.	LENGTH (mm)
BLPSTHD1215	381



1/2" Speeder

BLPS12

Packing: 6

- Manufactured from high grade steel alloy
- Features a Lifetime Warranty and exceeds ANSI Standards



PART NO.	LENGTH (mm)
BLPS12	457

1/2" Sliding Head

BLPSH1238

Packing: 6

- Manufactured from high grade steel alloy
- Features a Lifetime Warranty and exceeds ANSI Standards



PART NO.	LENGTH (mm)
BLPSH1238	37

1/2" Extension, Knurled

Packing: 6

- Manufactured from high grade steel alloy
- Features a Lifetime Warranty and exceeds ANSI Standards

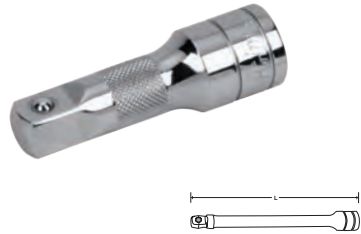

PART NO.	LENGTH (mm)
BLPEXTK123	76
BLPEXTK125	127
BLPEXTK126	152
BLPEXTK1210	254

1/2" Locking Extension

Packing: 6

- Manufactured from high grade steel alloy
- Features a Lifetime Warranty and exceeds ANSI Standards



PART NO.	LENGTH (mm)
SXLBP3	76
SXLBP6	152
SXLBP10	254

1/2" Universal Joint

BLPUJ12

Packing: 6

- Manufactured from high grade steel alloy
- Features a Lifetime Warranty and exceeds ANSI Standards



PART NO.	LENGTH (mm)
BLPUJ12	70

1/2" Adaptor

BLPAFM1238

Packing: 6

- Manufactured from high grade steel alloy
- Features a Lifetime Warranty and exceeds ANSI Standards



PART NO.	INTERNAL SQ. DRIVE (inches)	EXTERNAL SQ. DRIVE (inches)
BLPAFM1238	1/2	3/8

1/2" Impact Socket, Shallow, mm, 6-Point

Packing: 6

- Designed for maximum engagement on 6-point fasteners
- Suitable for use with pneumatic and electric impact wrenches
- Specially heat treated for impact use to provide long life, safety, and durability
- Drive end features pin retention hole and groove



PART NO.	SIZE (mm)
BLPSMIM1210	10
BLPSMIM1211	11
BLPSMIM1212	12
BLPSMIM1213	13
BLPSMIM1214	14
BLPSMIM1215	15
BLPSMIM1216	16
BLPSMIM1217	17
BLPSMIM1218	18

PART NO.	SIZE (mm)
BLPSMIM1219	19
BLPSMIM1221	21
BLPSMIM1222	22
BLPSMIM1223	23
BLPSMIM1224	24
BLPSMIM1227	27
BLPSMIM1229	29
BLPSMIM1230	30
BLPSMIM1232	32

1/2" Impact Socket, Shallow, Inches, 6-Point

Packing: 6

- Designed for maximum engagement on 6-point fasteners
- Suitable for use with pneumatic and electric impact wrenches
- Specially heat treated for impact use to provide long life, safety, and durability
- Drive end features pin retention hole and groove



PART NO.	SIZE (inches)
BLPSIM1238	3/8
BLPSIM12716	7/16
BLPSIM1212	1/2
BLPSIM12916	9/16
BLPSIM1258	5/8
BLPSIM121116	11/16
BLPSIM1234	3/4
BLPSIM121316	13/16

PART NO.	SIZE (inches)
BLPSIM1278	7/8
BLPSIM121516	15/16
BLPSIM121	1
BLPSIMB121116	1 1/16
BLPSIMB12118	1 1/8
BLPSIMB12114	1 1/4
BLPSIMB121516	1 5/16
BLPSIMB121716	1 7/16

1/2" Impact Socket, Deep, mm, 6-Point

Packing: 6

- Designed for maximum engagement on 6-point fasteners
- Suitable for use with pneumatic and electric impact wrenches
- Specially heat treated for impact use to provide long life, safety, and durability
- Drive end features pin retention hole and groove



PART NO.	SIZE (mm)
BLPLSMIM1210	10
BLPLSMIM1211	11
BLPLSMIM1212	12
BLPLSMIM1213	13
BLPLSMIM1214	14
BLPLSMIM1215	15
BLPLSMIM1216	16
BLPLSMIM1217	17
BLPLSMIM1218	18

PART NO.	SIZE (mm)
BLPLSMIM1219	19
BLPLSMIM1221	21
BLPLSMIM1222	22
BLPLSMIM1224	24
BLPLSMIM1226	26
BLPLSMIM1227	27
BLPLSMIM1229	29
BLPLSMIM1230	30
BLPLSMIM1232	32

1/2" Impact Socket, Deep, Inches, 6-Point

Packing: 6

- Designed for maximum engagement on 6-point fasteners
- Suitable for use with pneumatic and electric impact wrenches
- Specially heat treated for impact use to provide long life, safety, and durability
- Drive end features pin retention hole and groove



PART NO.	SIZE (inches)
BLPLSIM1238	3/8
BLPLSIM12716	7/16
BLPLSIM1212	1/2
BLPLSIM12916	9/16
BLPLSIM1258	5/8
BLPLSIM121116	11/16
BLPLSIM1234	3/4
BLPLSIM121316	13/16

PART NO.	SIZE (inches)
BLPLSIM1278	7/8
BLPLSIM121516	15/16
BLPLSIM121	1
BLPLSIMB121116	1 1/16
BLPLSIMB12118	1 1/8
BLPLSIMB121316	1 3/16
BLPLSIMB12114	1 1/4



4-Lug 4WD Spindle Nut Socket

SNS2467

Packing: 1

- Remove and install 4-slot axle lock nuts
- 1/2- to 3/4-ton Dana® 44 axle
- Socket I.D.: 2"



4-Lug Extension Spindle Nut Socket

SNS3195

Packing: 1

- For high-shear rotating nuts
- 1/2-ton Dana 80 axle
- Socket I.D.: 2-3/8"



4-Lug 4WD Spindle Nut Socket

SNS3246

Packing: 1

- Remove and install 4-slot axle lock nuts
- 3/4- to 1-ton
- Socket I.D.: 2-1/4"



Plastic Lug Socket Set

BLPIM12S3P

Packing: 1

- 3 sizes: 17 mm (Blue), 19 mm (Yellow), 21 mm (Red)
- Material: Cr-Mo
- Length: 85 mm
- Laser marking for easy identification
- 1/2" Drive, thin wall deep impact socket set
- Plastic lug to protect against damage to wheel hub



6-Lug 4WD Spindle Nut Socket

SNS2770

Packing: 1

- Remove and install 4-slot front axle lock nuts
- 3/4- to 1-ton Dana 44 axle
- Socket I.D.: 2-1/4"



1/2" Impact Swivel Socket

Packing: 10

- Laser welded pivot pin, means smooth, full 30° uninterrupted swivel action, which allows efficient power transfer prolonging the life of the socket
- Exceeds ANSI® performance standards
- 30° uninterrupted swivel action, means greater accessibility in tight quarters, which allows easier and faster removal of stubborn fasteners



1/2" Universal Joints

BLPJIM12

Packing: 6

- Specially heat treated for impact use to provide long life, safety, and durability
- Suitable for use with pneumatic and electric impact wrenches
- Drive end features pin retention hole and groove



PART NO.	SIZE (inches)
BLPJIM12	1/2 male x 1/2 female

PART NO.	SIZE (mm)	PART NO.	SIZE (mm)
BLPSS1210	10	BLPSS1218	18
BLPSS1211	11	BLPSS1219	19
BLPSS1212	12	BLPSS1220	20
BLPSS1213	13	BLPSS1221	21
BLPSS1214	14	BLPSS1222	22
BLPSS1215	15	BLPSS1223	23
BLPSS1216	16	BLPSS1224	24
BLPSS1217	17		



Flip Impact Socket Set, 4pcs

BLPFIM12S

Packing: 1

- 3 - 1/2" DR. Flip Impact Socket -
- - 13/16" * 3/4", 17mm * 19mm, 21mm * 7/8"
- 1 - 1/2" Extension
- 3" Material: Cr-Mo
- Packaging: BMC + Color Sleeve
- Can be used with extended anvil impact wrenches providing users with more options



1/2" Impact Adaptor

Packing: 6

- Specially heat treated for impact use to provide long life, safety, and durability
- Suitable for use with pneumatic and electric impact wrenches
- Drive end features pin retention hole and groove



BLPAIM3412



BLPAIM3812

PART NO.	SIZE (inches)
BLPAIM3412	3/4 male x 1/2 female
BLPAIM3812	3/8 male x 1/2 female

1/2" Extension

Packing: 6

- Specially heat treated for impact use to provide long life, safety, and durability
- Suitable for use with pneumatic and electric impact wrenches
- Drive end features pin retention hole and groove



PART NO.	SIZE (inches)
BLPEXIM123	3
BLPEXIM125	5
BLPEXIM126	6
BLPEXIM1210	10

3/4" Quick Release Ratchet

BPRSR942

Packing: 6

- Features quick release button for rapid socket/accessory changes, even with greasy or oily hands
- Contoured handle for comfort and control
- Chrome finish for easy clean-up
- All ratchets in series meet or exceed ANSI B107-10M-1996 specifications

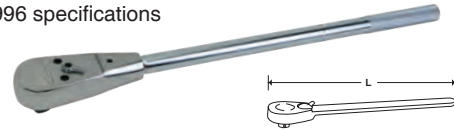

PART NO.	SQ. DRIVE (inches)	LENGTH (mm)
BPRSR942	3/4	508

3/4" Breaker Bar

BLPBB3419

Packing: 6

- Manufactured from high grade steel alloy
- Features a Lifetime Warranty and exceeds ANSI Standards



PART NO.	LENGTH (mm)
BLPBB3419	483

3/4" Sliding T-Handle

BLPSTHD3418

Packing: 6

- Manufactured from high grade steel alloy
- Features a Lifetime Warranty and exceeds ANSI Standards



PART NO.	LENGTH (mm)
BLPSTHD3418	457

3/4" L-Shape Wrench

BLPLW3415

Packing: 6

- Manufactured from high grade steel alloy
- Features a Lifetime Warranty and exceeds ANSI Standards



PART NO.	LENGTH (mm)
BLPLW3415	381



3/4" Socket, mm, 6-Point

Packing: 6

- Manufactured from high grade steel alloy
- Features a Lifetime Warranty and exceeds ANSI Standards



PART NO.	SIZE (mm)	LENGTH (mm)
BLPM3419	19	50
BLPM3420	20	
BLPM3421	21	
BLPM3422	22	
BLPM3423	23	
BLPM3424	24	51
BLPM3425	25	52
BLPM3426	26	
BLPM3427	27	
BLPM3428	28	
BLPM3429	29	54
BLPM3430	30	
BLPM3432	32	
BLPM3433	33	56
BLPM3434	34	58
BLPM3435	35	
BLPM3436	36	
BLPM3438	38	60
BLPM3441	41	64
BLPM3446	46	66
BLPM3450	50	70
BLPM3455	55	76
BLPM3460	60	78

3/4" Socket, mm, 12-Point

Packing: 6

- Manufactured from high grade steel alloy
- Features a Lifetime Warranty and exceeds ANSI Standards

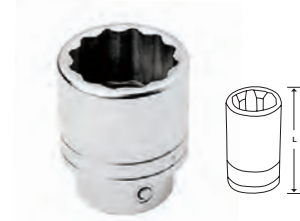

PART NO.	SIZE (mm)	LENGTH (mm)
BLPDM3419	19	47
BLPDM3421	21	
BLPDM3422	22	
BLPDM3423	23	50
BLPDM3424	24	
BLPDM3425	25	53
BLPDM3426	26	
BLPDM3427	27	
BLPDM3428	28	
BLPDM3429	29	58
BLPDM3430	30	
BLPDM3432	32	
BLPDM3433	33	60
BLPDM3434	34	
BLPDM3435	35	63
BLPDM3436	36	
BLPDM3438	38	
BLPDM3441	41	66
BLPDM3446	46	68
BLPDM3450	50	
BLPDM3455	55	69
BLPDM3460	60	72

3/4" Extension

Packing: 6

- Manufactured from high grade steel alloy
- Features a Lifetime Warranty and exceeds ANSI Standards

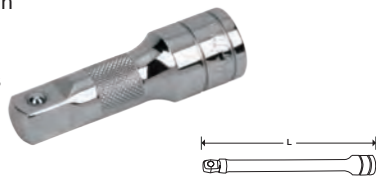

PART NO.	LENGTH (mm)
BLPEXT344	102
BLPEXT348	203
BLPEXT3416	406

3/4" Universal Joint

Packing: 6

- Manufactured from high grade steel alloy
- Features a Lifetime Warranty and exceeds ANSI Standards



PART NO.	LENGTH (mm)
BLPUJ34	110

3/4" Impact Socket, Shallow, mm, 6-Point

Packing: 6

- Designed for maximum engagement on 6-point fasteners
- Suitable for use with pneumatic and electric impact wrenches
- Specially heat treated for impact use to provide long life, safety, and durability
- Drive end features pin retention hole and groove



PART NO.	SIZE (mm)
BLPSMIM3417	17
BLPSMIM3418	18
BLPSMIM3419	19
BLPSMIM3420	20
BLPSMIM3421	21
BLPSMIM3422	22
BLPSMIM3423	23
BLPSMIM3424	24
BLPSMIM3425	25
BLPSMIM3426	26
BLPSMIM3427	27
BLPSMIM3428	28
BLPSMIM3429	29
BLPSMIM3430	30
BLPSMIM3431	31
BLPSMIM3432	32
BLPSMIM3433	33
BLPSMIM3434	34
BLPSMIM3435	35
BLPSMIM3436	36
BLPSMIM3437	37
BLPSMIM3438	38

PART NO.	SIZE (mm)
BLPSMIM3439	39
BLPSMIM3440	40
BLPSMIM3441	41
BLPSMIM3442	42
BLPSMIM3443	43
BLPSMIM3444	44
BLPSMIM3445	45
BLPSMIM3446	46
BLPSMIM3447	47
BLPSMIM3448	48
BLPSMIM3449	49
BLPSMIM3450	50
BLPSMIM3452	52
BLPSMIM3454	54
BLPSMIM3455	55
BLPSMIM3456	56
BLPSMIM3457	57
BLPSMIM3458	58
BLPSMIM3459	59
BLPSMIM3460	60
BLPSMIM3463	63
BLPSMIM3465	65

3/4" Impact Socket, Shallow, Inches, 6-Point

Packing: 6

- Designed for maximum engagement on 6-point fasteners
- Suitable for use with pneumatic and electric impact wrenches
- Specially heat treated for impact use to provide long life, safety, and durability
- Drive end features pin retention hole and groove



PART NO.	SIZE (inches)
BLPSIM341116	11/16
BLPSIM3434	3/4
BLPSIM341316	13/16
BLPSIM3478	7/8
BLPSIM341516	15/16
BLPSIM341	1
BLPSIMB341116	1 1/16
BLPSIMB34118	1 1/8
BLPSIMB341316	1 3/16
BLPSIMB34114	1 1/4
BLPSIMB341516	1 5/16
BLPSIMB34138	1 3/8
BLPSIMB341716	1 7/16
BLPSIMB34112	1 1/2
BLPSIMB341916	1 9/16
BLPSIMB34158	1 5/8
BLPSIMB3411116	1 11/16
BLPSIMB34134	1 3/4
BLPSIMB3411316	1 13/16
BLPSIMB34178	1 7/8
BLPSIMB3411516	1 15/16
BLPSIMB342	2



3/4" Impact Socket, Deep, mm, 6-Point

- Designed for maximum engagement on 6-point fasteners
- Suitable for use with pneumatic and electric impact wrenches
- Specially heat treated for impact use to provide long life, safety, and durability
- Drive end features pin retention hole and groove



Packing: 6

PART NO.	SIZE (mm)	PART NO.	SIZE (mm)
BLPLSMIM3417	17	BLPLSMIM3434	34
BLPLSMIM3418	18	BLPLSMIM3435	35
BLPLSMIM3419	19	BLPLSMIM3436	36
BLPLSMIM3420	20	BLPLSMIM3437	37
BLPLSMIM3421	21	BLPLSMIM3438	38
BLPLSMIM3422	22	BLPLSMIM3440	40
BLPLSMIM3423	23	BLPLSMIM3441	41
BLPLSMIM3424	24	BLPLSMIM3442	42
BLPLSMIM3425	25	BLPLSMIM3443	43
BLPLSMIM3426	26	BLPLSMIM3444	44
BLPLSMIM3427	27	BLPLSMIM3445	45
BLPLSMIM3428	28	BLPLSMIM3446	46
BLPLSMIM3429	29	BLPLSMIM3447	47
BLPLSMIM3430	30	BLPLSMIM3448	48
BLPLSMIM3431	31	BLPLSMIM3449	49
BLPLSMIM3432	32	BLPLSMIM3450	50
BLPLSMIM3433	33	BLPLSMIM3455	55

3/4" Impact Adaptor

BLPAIM1234

- Specially heat treated for impact use to provide long life, safety, and durability
- Suitable for use with pneumatic and electric impact wrenches
- Drive end features pin retention hole and groove



Packing: 6

PART NO.	SIZE (inches)
BLPAIM1234	1/2 male x 3/4 female

3/4" Impact Adaptor

BLPAIM134

- Specially heat treated for impact use to provide long life, safety, and durability
- Suitable for use with pneumatic and electric impact wrenches
- Drive end features pin retention hole and groove



Packing: 6

PART NO.	SIZE (inches)
BLPAIM134	1 male x 3/4 female

3/4" Universal Joint

BLPJIM34

- Specially heat treated for impact use to provide long life, safety, and durability
- Suitable for use with pneumatic and electric impact wrenches
- Drive end features pin retention hole and groove



Packing: 6

PART NO.	SIZE (inches)
BLPJIM34	3/4 male x 3/4 female

NEW! 3/4" Impact Swivel Socket

- Laser welded pivot pin, means smooth, full 30° uninterrupted swivel action, which allows efficient power transfer prolonging the life of the socket
- Exceeds ANSI® performance standards
- 30° uninterrupted swivel action, means greater accessibility in tight quarters, which allows easier and faster removal of stubborn fasteners



Packing: 10

PART NO.	SIZE (mm)	PART NO.	SIZE (mm)
BLPSS3419	19	BLPSS3433	33
BLPSS3420	20	BLPSS3434	34
BLPSS3421	21	BLPSS3435	35
BLPSS3422	22	BLPSS3436	36
BLPSS3423	23	BLPSS3437	37
BLPSS3424	24	BLPSS3438	38
BLPSS3425	25	BLPSS3439	39
BLPSS3426	26	BLPSS3440	40
BLPSS3427	27	BLPSS3441	41
BLPSS3428	28	BLPSS3442	42
BLPSS3429	29	BLPSS3443	43
BLPSS3430	30	BLPSS3444	44
BLPSS3431	31	BLPSS3445	45
BLPSS3432	32	BLPSS3446	46

3/4" Extension

- Specially heat treated for impact use to provide long life, safety, and durability
- Suitable for use with pneumatic and electric impact wrenches
- Drive end features pin retention hole and groove



Packing: 6

PART NO.	SIZE (inches)	PART NO.	SIZE (inches)
BLPEXIM343	3 1/2	BLPEXIM348	8
BLPEXIM344	4	BLPEXIM3410	10
BLPEXIM346	6	BLPEXIM3413	13
BLPEXIM347	7		

1" Impact Socket, Shallow, mm, 6-Point

Packing: 6

- Designed for maximum engagement on 6-point fasteners
- Suitable for use with pneumatic and electric impact wrenches
- Specially heat treated for impact use to provide long life, safety, and durability
- Drive end features pin retention hole and groove



PART NO.	SIZE (mm)
BLPSMIM117	17
BLPSMIM118	18
BLPSMIM119	19
BLPSMIM120	20
BLPSMIM121	21
BLPSMIM122	22
BLPSMIM123	23
BLPSMIM124	24
BLPSMIM125	25
BLPSMIM126	26
BLPSMIM127	27
BLPSMIM128	28
BLPSMIM129	29
BLPSMIM130	30
BLPSMIM131	31
BLPSMIM132	32
BLPSMIM133	33
BLPSMIM134	34
BLPSMIM135	35
BLPSMIM136	36
BLPSMIM137	37
BLPSMIM138	38
BLPSMIM139	39
BLPSMIM140	40
BLPSMIM141	41

PART NO.	SIZE (mm)
BLPSMIM142	42
BLPSMIM143	43
BLPSMIM144	44
BLPSMIM145	45
BLPSMIM146	46
BLPSMIM147	47
BLPSMIM148	48
BLPSMIM149	49
BLPSMIM150	50
BLPSMIM151	51
BLPSMIM152	52
BLPSMIM153	53
BLPSMIM154	54
BLPSMIM155	55
BLPSMIM156	56
BLPSMIM157	57
BLPSMIM158	58
BLPSMIM159	59
BLPSMIM160	60
BLPSMIM163	63
BLPSMIM165	65
BLPSMIM167	67
BLPSMIM168	68
BLPSMIM169	69

1" Impact Socket, Deep, mm, 6-Point

Packing: 6

- Designed for maximum engagement on 6-point fasteners
- Suitable for use with pneumatic and electric impact wrenches
- Specially heat treated for impact use to provide long life, safety, and durability
- Drive end features pin retention hole and groove



PART NO.	SIZE (mm)
BLPLSMIM117	17
BLPLSMIM118	18
BLPLSMIM119	19
BLPLSMIM120	20
BLPLSMIM121	21
BLPLSMIM122	22
BLPLSMIM123	23
BLPLSMIM124	24
BLPLSMIM125	25
BLPLSMIM126	26
BLPLSMIM127	27
BLPLSMIM128	28
BLPLSMIM129	29
BLPLSMIM130	30
BLPLSMIM131	31

PART NO.	SIZE (mm)
BLPLSMIM132	32
BLPLSMIM133	33
BLPLSMIM134	34
BLPLSMIM135	35
BLPLSMIM136	36
BLPLSMIM137	37
BLPLSMIM138	38
BLPLSMIM140	40
BLPLSMIM141	41
BLPLSMIM142	42
BLPLSMIM143	43
BLPLSMIM146	46
BLPLSMIM149	49
BLPLSMIM150	50
BLPLSMIM155	55



1" Extension

Packing: 6

- Specially heat treated for impact use to provide long life, safety, and durability
- Suitable for use with pneumatic and electric impact wrenches
- Drive end features pin retention hole and groove



PART NO.	SIZE (inches)
BLPEXIM17	7
BLPEXIM113	13

1" Universal Joint

BLPJIM1

Packing: 6

- Specially heat treated for impact use to provide long life, safety, and durability
- Suitable for use with pneumatic and electric impact wrenches
- Drive end features pin retention hole and groove



PART NO.	SIZE (inches)
BLPJIM1	7

1" Impact Adaptor

BLPAIM341

Packing: 6

- Specially heat treated for impact use to provide long life, safety, and durability
- Suitable for use with pneumatic and electric impact wrenches
- Drive end features pin retention hole and groove



PART NO.	SIZE (inches)
BLPAIM341	3/4 male x 1 female

1" Impact Adaptor

BLPAIM1121

Packing: 6

- Specially heat treated for impact use to provide long life, safety, and durability
- Suitable for use with pneumatic and electric impact wrenches
- Drive end features pin retention hole and groove



PART NO.	SIZE (inches)
BLPAIM1121	1 1/2 male x 1 female

TORQUE TOOLS



Blue-Point™



Blue-Point[®]

Unmatched Accuracy & Precision



Adjustable Click-Type Torque Wrench

Adjustable Click-Type Torque Wrench

Packing: 1

- Dual scale, calibrated dual direction
- Positive lock with spring loaded pull down lock ring
- Fast, accurate and easy to set
- Easy-to-read laser marked scales
- Most feature quick release buttons which provide good socket retention as well as easy socket removal
- Accuracy: $\pm 3\%$ CW $\pm 4\%$ CCW of indicated value, CW, from 20% to 100% of full scale
- Meets or exceeds ASME B107.14-2004, ISO 6789 standards
- Individually serialized with matching certificate of calibration traceable to N.I.S.T.



PART NO.	SQ. DRIVE (inches)	RANGE (Nm)	RANGE (ft.lb.)	INCREMENT (Nm)	A (mm)	B (mm)	WEIGHT (g)
BP501NMRMH	1/4	1.0 - 5.0	1 - 4	0.06	258	27	386
BP2502NMRMH	3/8	4.0 - 27.7	3 - 20	0.12	286	27	431
BP602NMRMH	3/8	10 - 60	8 - 45	0.5	406	36	1,134
BP1002NMRMH	3/8	20 - 100	15 - 75	0.5	406	36	1,134
BP2003NMRMH	1/2	40 - 200	30 - 147.5	2	483	43	1,474
BP3403NMRMH	1/2	60 - 340	45 - 250	2	620	43	1,542
BP8004NMRMH	3/4	150 - 800	110 - 600	5	1,067	64	5,375
BP15005NMRMH	1	300 - 1500	220 - 1100	10	1,778	76	11,385

Adjustable Click-Type Torque Wrench

Packing: 1

- Aluminium alloy body with high durability satin plated finish
- Comfort-Grip handle
- 36 tooth ratchet heads; tighter "swing arc" than competitor 24T models
- Ratchets are bi-directional
- Long life – Blue-Point torque wrenches survived 25,000 cycle testing in both directions
- Single scale in Nm is standard, but dual scale Nm/ft.lb. can also be available
- Cardboard box packaging with calibration certificate

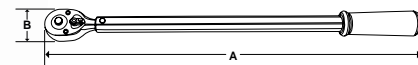

PART NO.	SQ. DRIVE (inches)	RANGE (Nm)	RANGE (ft.lb.)	INCREMENT (Nm)	A (mm)	B (mm)	WEIGHT (g)
BP602NMRPHZ	3/8	10 - 60	7.3 - 44.2	0.5	406	36	1,134
BP1002NMRPHZ	3/8	20 - 100	14.7 - 73.7	0.5	406	36	1,134
BP2003NMRPHZ	1/2	40 - 200	30 - 147.5	2	483	43	1,474
BP3403NMRPHZ	1/2	60 - 340	44.2 - 250.8	2	620	43	1,542

Preset Click-Type Torque Wrench, "L" Series

Packing: 1

- A higher performance wrench than similar ones offered by the competitor
- Blue-Point ratchet heads are smaller than competitor
- Blue-Point 40 tooth ratchet head vs. the competitor; much less "swing arc"
- Blue-Point wrench tubes are smaller diameter at the throat; greater access
- Ratchets are bi-directional
- High durability – survived 50,000 cycle testing in both directions; competitor failed at 12,000 cycles
- Improved calibration performance; Blue-Point remained calibrated after 25,000 cycles. Competitors wrench fell out of calibration prior to required 5,000 cycles

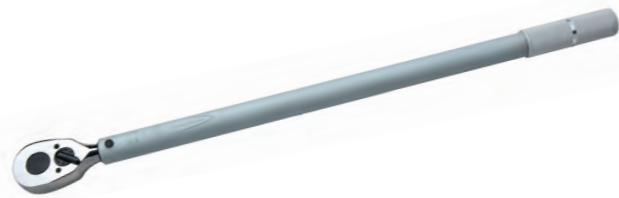

PART NO.	SQ. DRIVE (inches)	RANGE (Nm)	RANGE (ft.lb.)	LENGTH (mm)	WEIGHT (g)
BP10T-2RL	3/8	4 - 30	21 - 20.4	184	450
BP50T-2RL	3/8	10 - 100	7.3 - 72.2	350	700
BP100T-3RL	1/2	35 - 200	25 - 147.5	530	1220
BP200T-3RL	1/2	45 - 280	34.6 - 200	630	1380
BP250T-3RL	1/2	60 - 340	44.2 - 250.8	630	1380

Preset Click-Type Torque Wrench

Packing: 1

- All parts are made of alloy steel for maximum life and calibration retention
- Square drives meet industrial requirements and government specifications
- Torques in both left and right hand directions
- Accuracy: $\pm 3\%$ CW $\pm 4\%$ CCW of indicated value
- Automatic re-set when force on handle is released
- Torque limiting positive sensory "click" when pre-set
- Smooth knurled steel hand hold for comfortable, safe grip
- Handle length proportioned to torque range of wrench for minimum user fatigue
- Tamper proof torque setting for production line use
- Torque values can be calibrated in English and Metric settings

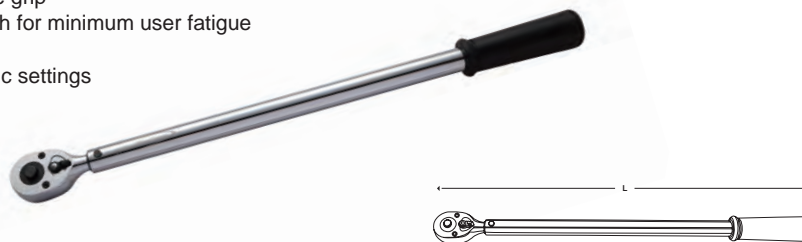

PART NO.	SQ. DRIVE (inches)	RANGE (Nm)	RANGE (ft.lb.)	RANGE (in.lb.)	RANGE (M Kg)	LENGTH (mm)	WEIGHT (g)
BP5T-1R	1/4	1.4 - 5.4	1 - 5	12 - 60	0.10 - 0.70	165	227
BP10T-2R	3/8	3.9 - 27.7	3 - 9	36 - 108	0.42 - 1.24	184	397
BP50T-2R	3/8	10.2 - 98.3	10 - 50	120 - 600	1.25 - 7.00	292	680
BP100T-3R	1/2	34 - 197	45 - 150	540 - 1800	6.00 - 20.00	502	1,247
BP200T-3R	1/2	47 - 272	45 - 200	540 - 2400	6.00 - 27.00	603	1,361
BP300T-4R	3/4	85 - 400	100 - 300	1200 - 3600	14.00 - 42.00	711	2,155
BP600T-4R	3/4	280 - 830	200 - 600	2400 - 7200	28.00 - 83.00	1,321	5,443

Preset Click-Type Torque Wrench, Interchangeable Head

Packing: 1

- 8 models available with torque ranges from 10 in.lb. to 600 ft.lb.
- Featuring a durable, non-slip cushion grip
- Uses universal round shank heads
- Audible click and feel impulse torque control mechanism
- Tamper proof torque setting for production line use
- Torque values can be calibrated in English or metric setting
- Accuracy: $\pm 4\%$ of indicated value, from 20% to 100% of full scale
- Meets or exceeds ASME B107.14-2004, ISO 6789
- Optional Calibration certificate available at additional cost

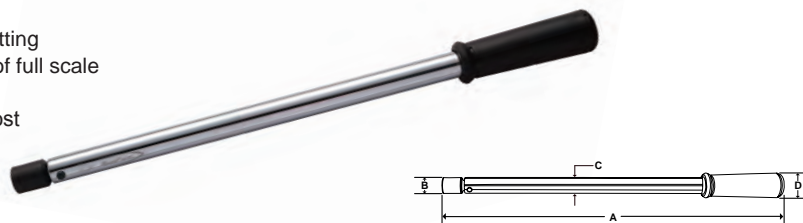

PART NO.	SHANK SIZE	ENGLISH RANGE	RANGE (Nm)	A (mm)	B (mm)	C (mm)	D (mm)	WEIGHT (g)
BP5T-I	J	10 - 50 in.lb.	1.1 - 5.6	165	16	15	25	159
BP10T-I	J	50 - 250 in.lb.	5.6 - 28	254	16	15	25	249
BP10ST-I	J	60 - 300 in.lb.	6.8 - 34	157	17	22	36	340
BP50T-I	J	15 - 75 ft.lb.	20 - 102	279	17	22	36	635
BP100T-I	Y	30 - 150 ft.lb.	41 - 203	495	24	22	36	1,043
BP200T-I	Y	40 - 200 ft.lb.	54 - 271	597	24	22	36	1,179
BP300T-I	X	100 - 300 ft.lb.	135 - 406	704	28	25	36	1,769
BP600T-I	Z	120 - 600 ft.lb.	162 - 814	1,397	38	32	32	4,740



Ratcheting Interchangeable Head

Allows use of torque wrench bodies with sockets, crowfoot wrenches, or other similar attachment

Center of fastener to retaining pin:

- * J Series - 2.50"
- * Y Series - 3.00"
- * X Series - 4.50"
- * Z Series - 5.75"



* U.S. Patent 6,125,722 applies to these ratchet heads. Value in parentheses in chart is the Maximum Recommended Working Torque, in.lb.

SQ. DRIVE (inches)	SHANK SIZE J	SHANK SIZE Y	SHANK SIZE X	SHANK SIZE Z	HEAD O.D. (mm)	DEPTH (mm)	RATCHET SERVICE KIT
1/4	QJD8A-72* (350)	—	—	—	3	3.5	RKRT936
3/8	QJD12A* (900)	QYD12A* (1,200)	—	—	17	4.4	RKRF936
1/2	QJD16A* (900)	QYD16A* (2,400)	QXD16A* (3,000)	—	17	4.4	RKRS936
3/4	—	—	QXD24A (3,600)	QZD24B (7,200)	20	4.4	RKRQC4
1	—	—	QXD32A (3,600)	QZD32B (7,200)	20	4.4	RKRQC5

Open End Head, mm



Value in parentheses in chart is the Maximum Recommended Working Torque, in.lb.

mm	SHANK SIZE J	SHANK SIZE Y	SHANK SIZE X	SHANK SIZE Z	HEAD O.D. (mm)	HEAD DEPTH (mm)
6	QJOM6A (60)	—	—	—	13.5	3.6
7	QJOM7A (75)	—	—	—	13.5	3.6
8	QJOM8A (120)	—	—	—	16.5	3.3
9	QJOM9A (170)	—	—	—	19.8	4.8
10	QJOM10A (265)	—	—	—	19.8	4.8
11	QJOM11A (400)	—	—	—	22.9	5.6
12	QJOM12A (430)	—	—	—	26.9	6.1
13	QJOM13A (495)	—	—	—	26.9	6.1
14	QJOM14A (665)	QYOM14A (665)	—	—	29.5	6.6
15	QJOM15A (885)	QYOM15A (885)	—	—	33.3	6.9
16	QJOM16A (900)	QYOM16A (1,060)	—	—	33.3	6.9
17	QJOM17A (900)	QYOM17A (1,235)	—	—	37.1	7.3
18	QJOM18A (900)	QYOM18A (1,375)	QXOM18A (1,375)	—	37.1	7.3
19	QJOM19A (900)	QYOM19A (1,650)	QXOM19A (1,650)	—	40.4	7.6

mm	SHANK SIZE J	SHANK SIZE Y	SHANK SIZE X	SHANK SIZE Z	HEAD O.D. (mm)	HEAD DEPTH (mm)
20	—	QYOM20A (1,925)	QXOM20A (1,925)	—	43.7	9.2
21	QJOM21A (900)	QYOM21A (2,160)	QXOM21A (2,160)	—	43.7	9.2
22	QJOM22A (900)	QYOM22A (2,400)	QXOM22A (2,470)	—	43.7	9.2
23	QJOM23A (900)	QYOM23A (2,400)	QXOM23A (2,745)	—	47	10
24	QJOM24A (900)	QYOM24A (2,400)	QXOM24A (2,970)	QZOM24A (2,970)	49	11
25	QJOM25A (900)	QYOM25A (2,400)	—	QZOM25A (3,295)	52	11
26	QJOM26A (900)	—	QXOM26A (3,570)	QZOM26A (3,570)	53	11
27	QJOM27A (900)	QYOM27A (2,400)	—	QZOM27A (3,825)	55	12
29	—	QYOM29A (2,400)	QXOM29A (3,600)	QZOM29A (4,550)	58	12
30	—	QYOM30A (2,400)	QXOM30A (3,600)	QZOM30A (4,950)	61	13
32	—	QYOM32A (2,400)	QXOM32A (3,600)	QZOM32A (5,755)	65	14
34	—	QYOM34A (2,400)	QXOM34A (3,600)	QZOM34A (6,595)	68	14
36	—	QYOM36A (2,400)	QXOM36A (3,600)	QZOM36A (7,200)	74	15

COMPUTORQ 3 Digital Torque Wrench

- Uses CR123 replaceable batteries
- Audible tone indication



1 Flexibility
15° flexible
ratchet head



2 Accurate Reading
Real-time torque readings



3 LED Indicators
3-colour LED
light indicators



4 Comfort
Ergonomic handle



COMPUTORQ 3 Digital Torque Wrench

Packing: 1

- Sleek new design
- 15° flex ratcheting head
- Push button socket release head
- Large, easy to read digital display
- Long battery life, uses 2 each CR123 lithium batteries
- Ergonomically designed molded non-slip rubber grip
- Torques in both clockwise and counterclockwise directions
- Battery saving auto-shutoff after two minutes
- COMPUTORQ 3 remembers last unit and torque setting selected
- Audible tone sounds when set torque value is reached, if the set torque value is exceeded, an alarm tone will sound
- 3 color LED light bar:
 - YELLOW LED indicates approaching desired torque setting
 - GREEN LED indicates desired torque value is reached
 - RED LED indicates fastener was overtorqued, loosen and retighten
- When desired torque value is reached, display will hold value and flash for ten seconds
- COMPUTORQ 3 will operate in any of four torque units, foot pound (ft.lb.), inch pound (in.lb.), newton meter (Nm) or kilogram centimeter (kg.cm.)
- ACCURACY:
 - ± 2% CW of readings from 10% to 100% of full scale
 - ± 3% CCW of readings from 20% to 100% of full scale
- N.I.S.T. traceable certificate of calibration included
- Meets or exceeds ASME B107.28 - 2005

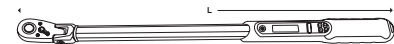

PART NO.	SQ. DRIVE (inches)	RANGE (ft.lb.)	RANGE (in.lb.)	RANGE (Nm)	RANGE (kg.cm.)	LENGTH (mm)	WEIGHT (g)
BP2401CI3	1/4	2.0 - 20.0	24 - 240	2.71 - 27.10	27.6 - 276	381	910
BP1002CF3	3/8	10.0 - 100.0	120 - 1200	13.6 - 135.6	138 - 1382	432	1,000
BP2503CF3	1/2	25 - 250	300 - 3000	33.8 - 338	345 - 3456	686	1,590

Digital Torque Tester

- Remember last 500 cycle counts
- Audible tone signals



1 Intuitive Display
LCD touchscreen with colour display

2 Convenience
Uses disposable batteries and AC adaptor

3 Precision
High accuracy of $\pm 0.5\%$

Digital Torque Tester

Packing: 1

- Integral Transducer and sturdy housing allow mounting in virtually any position
- Integral Transducer: Full bridge strain gage, 350 ohm, 1500uE, 3mV/V F.S, 3.75 excitation
- Units of Torque: Nm, kg.cm., ft.lb., in.lb., in.oz.
- Audible (tone)
- Torque Accuracy: $\pm 0.5\% \pm 1\%$ count CW and CCW from 10% to 100% of full scale at 25° C
- LCD Touch Screen: 4.7 inch color graphics display
- Screen resolution: 480 X 272 pixels
- Display Accuracy: 4 digits, 500 cycle counts
- 6 "AA" Alkaline cells for battery power included
- Track, Peak and First Peak modes of operation
- Operating Temperature: 40° to 110° F (5° to 42° C)
- Storage Temperature: 0° to 122° F (-20° to 50° C)
- Humidity up to 85% non-condensing
- ISO-6789-2003 and ASME B107-28-2005 standards compliant
- Certificate of N.I.S.T. traceability from 10% to 100% of full scale
- Includes storage case, AC adapter and USB cable 110v - 220v
- Dates & times, serial numbers, required accuracy vs actual readings, percentage error & users of torque wrenches tested are stored



PART NO.	SQ. DRIVE (inches)	ENGLISH RANGE	RANGE (Nm)
BP1001-O-DTT	1/4	10 - 100 in.oz.	0.07 - 0.706
BP501-I-DTT	1/4	5 - 50 in.lb.	0.56 - 5.65
BP2502-I-DTT	3/8	25 - 250 in.lb.	2.82 - 28.25
BP2503-F-DTT	1/2	25 - 250 ft.lb.	33.90 - 338.9
BP6004-F-DTT	3/4	60 - 600 ft.lb.	81.35 - 813.5
BP10002-I-DTT	3/8	100 - 1000 in.lb.	11.3 - 113

WRENCHES

Wide Range For Access In Turning

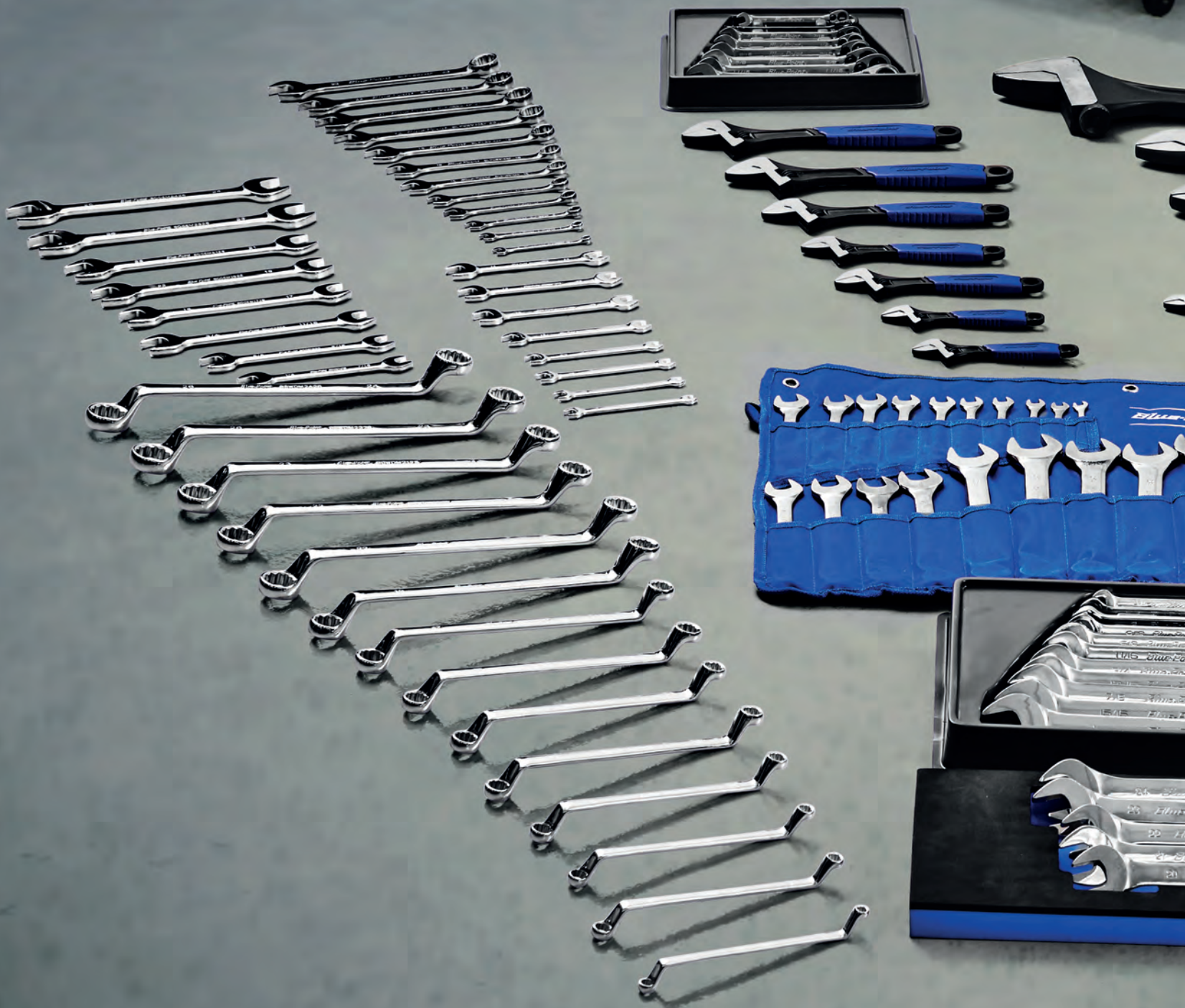

Blue-Point[®]



NEW! Flex Socket Combination Wrench Set, 8pcs
BLPCWRES8

Packing: 1 (Set)

- Higher Torque – 15% to 20% more turning power with Flank Drive wrenching system
- 12 point socket end gives great grip at either end making sure there is no slipping when tightening and loosening
- Flexible sockets wrench provides speed and accessibility to work round corners
- Open-end and flexible socket wrench provides maximum versatility
- Manufactured from chrome vanadium steel for strength and durability
- Full polished chrome finish easily wipes clean of oil and dirt
- Supplied in a canvas tool pouch for neat and easy storage and transportation



PART NO.	mm	L (mm)
BLPCWREF10	10	180
BLPCWREF11	11	190
BLPCWREF12	12	195
BLPCWREF13	13	210

PART NO.	mm	L (mm)
BLPCWREF14	14	230
BLPCWREF15	15	230
BLPCWREF17	17	235
BLPCWREF19	19	255

NEW! Flex Socket Combination Wrench

Packing: 10

- Higher Torque – 15% to 20% more turning power with Flank Drive wrenching system
- 12 point socket end gives great grip at either end making sure there is no slipping when tightening and loosening
- Flexible sockets wrench provides speed and accessibility to work round corners
- Open-end and flexible socket wrench provides maximum versatility
- Manufactured from chrome vanadium steel for strength and durability
- Full polished chrome finish easily wipes clean of oil and dirt



PART NO.	mm	L (mm)
BLPCWREF8	8	170
BLPCWREF9	9	170
BLPCWREF10	10	180
BLPCWREF11	11	190
BLPCWREF12	12	195
BLPCWREF13	13	210

PART NO.	mm	L (mm)
BLPCWREF14	14	230
BLPCWREF15	15	230
BLPCWREF16	16	235
BLPCWREF17	17	235
BLPCWREF18	18	255
BLPCWREF19	19	255

Combination, Long

Packing: 6

- Manufactured from high grade steel alloy
- Features a Lifetime Warranty and exceeds ANSI Standards



PART NO.	mm	L (mm)
BLPCWM36	36	432
BLPCWM38	38	432
BLPCWM41	41	445
BLPCWM46	46	483





Combination, Regular

Combination Wrench Set

BLPCWS23

- Manufactured from high grade steel alloy
- Features a Lifetime Warranty and exceeds ANSI Standards
- Set in pouch packaging



Packing: 1 (Set)

PART NO.	CONTENTS
BLPCWS23	Combination Wrenches Sizes: 6, 7, 8, 9, 10, 11, 12, 13, 14, 15, 16, 17, 18, 19, 20, 21, 22, 23, 24, 25, 27, 30, 32 mm

Combination, Regular

- Manufactured from high grade steel alloy Packing: 6
- Features a Lifetime Warranty and exceeds ANSI Standards
- New high polish



PART NO.	mm	L (mm)
BLPCWM6AP	6	104
BLPCWM7AP	7	110
BLPCWM8AP	8	120
BLPCWM9AP	9	125
BLPCWM10AP	10	135
BLPCWM11AP	11	144
BLPCWM12AP	12	155
BLPCWM13AP	13	165
BLPCWM14AP	14	175
BLPCWM15AP	15	184
BLPCWM16AP	16	195
BLPCWM17AP	17	204
BLPCWM18AP	18	215
BLPCWM19AP	19	229

PART NO.	mm	L (mm)
BLPCWM20AP	20	239
BLPCWM21AP	21	249.8
BLPCWM22AP	22	249.8
BLPCWM23AP	23	269
BLPCWM24AP	24	269
BLPCWM25AP	25	290
BLPCWM26AP	26	290
BLPCWM27AP	27	310
BLPCWM28AP	28	330
BLPCWM29AP	29	330
BLPCWM30AP	30	330
BLPCWM32AP	32	350
BLPCWM34AP	34	350

WRENCHES Combination

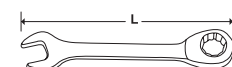

90

Adjustable Wrench Set, 3pcs

BLPADJ703

Packing: 3



PART NO.	CONTENTS
BLPADJ703	Adjustable Wrenches 15" GAJ15A, 18" GAJ18A, 24" GAJ24A

Adjustable Wrench Set, 4pcs

BLPADJ404

Packing: 4



PART NO.	CONTENTS
BLPADJ404	Adjustable Wrenches 6" GAJ6A, 8" GAJ8A, 10" GAJ10A, 12" GAJ12A

Adjustable Wrenches

- Wrench features a durable black phosphate finish
- Wide-open jaw design with polished head
- Heat treated steel alloy construction
- Inch scale laser etched on head face



PART NO.*	A (mm)	L (mm)	
GAJ4A	13	108	6
GAJ6A	25	160	6
GAJ8A	29	210	6
GAJ10A	33	260	6
GAJ12A	38	310	6
GAJ15A	43	385	4
GAJ18A	52	450	2
GAJ24A	62	610	1
GAJS30A	85	778	1

*For China & India

PART NO.**	A (mm)	L (mm)	
GAJ4AP	13	108	6
GAJ6AP	25	160	6
GAJ8AP	29	210	6
GAJ10AP	33	260	6
GAJ12AP	38	310	6
GAJ15AP	43	385	4
GAJ18AP	52	450	2
GAJ24AP	62	610	1
GAJS30AP	85	778	1

**For Rest of Asia



Adjustable Wrench Set, Soft Grip, 4pcs

BLPADJ404SG

Packing: 4



PART NO.	CONTENTS
BLPADJ404SG	Adjustable Wrenches, Soft Grip 6" GAJ6SG, 8" GAJ8SG, 10" GAJ10SG, 12" GAJ12SG

Adjustable Wrench Set, Composite Grip, 3pcs

BADJC703

Packing: 1



PART NO.	CONTENTS
BADJC703	Adjustable Wrenches, Composite Grip 6" BADJC6, 8" BADJC8, 10" BADJC10

Adjustable Soft Grip

Packing: 6

- Now the most popular Blue-Point® Adjustable Wrenches are available with soft grips
- Durable black phosphate finish
- Wide open jaw design with oversized capacity
- Laser-etched SAE/metric scale for easy determination of bolt size
- Soft Grip design for added comfort



PART NO.*	A (mm)	L (mm)
GAJ6SG	25	160
GAJ8SG	29	210
GAJ10SG	33	260
GAJ12SG	38	310

*For China & India

PART NO.**	A (mm)	L (mm)
GAJ6SGAP	25	160
GAJ8SGAP	29	210
GAJ10SGAP	33	260
GAJ12SGAP	38	310

**For Rest of Asia

Adjustable Composite Grip

Packing: 1

- Ergonomic, lightweight handle design reduces fatigue while providing easier gripping and greater balance
- Inch scale is laser etched on face
- Fully polished head
- Durable heat treated alloy construction



PART NO.*	A (mm)	L (mm)
BADJC6	25	164
BADJC8	30	218
BADJC10	35	267

*For China & India

PART NO.**	A (mm)	L (mm)
BADJC6AP	25	164
BADJC8AP	30	218
BADJC10AP	35	267

**For Rest of Asia

WRENCHES Adjustable

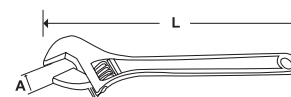

Ring End Wrench Set, 12pcs

BBWDSMSET12

Packing: 1(Set)

- Features a Lifetime Warranty and exceeds ANSI Standards
- Manufactured from high grade steel alloy
- Set in pouch packaging
- New high polish



PART NO.	A (mm)	L (mm)
BBWDSM67	6 - 7	160
BBWDSM89	8 - 9	175
BBWDSM1011	10 - 11	190
BBWDSM1213	12 - 13	205
BBWDSM1415	14 - 15	228
BBWDSM1617	16 - 17	232

PART NO.	A (mm)	L (mm)
BBWDSM1819	18 - 19	246
BBWDSM2022	20 - 22	268
BBWDSM2123	21 - 23	315
BBWDSM2427	24 - 27	360
BBWDSM2528	25 - 28	360
BBWDSM3032	30 - 32	405

45° / 75° Offset Double Ring

Packing: 6



45°



75°

PART NO.		mm		L (mm)	
45	75				
BBWSM67	BBWDM67	6 - 7	6 - 7	165	168
BBWSM89	BBWDM89	8 - 9	8 - 9	175	183
BBWSM810	BBWDM810	8 - 10	8 - 10	185	183
BBWSM911	BBWDM1011	9 - 11	10 - 11	195	198
BBWSM1011	BBWDM1012	10 - 11	10 - 12	195	198
BBWSM1012	BBWDM1113	10 - 12	11 - 13	195	218
BBWSM1113	BBWDM1213	11 - 13	12 - 13	205	218
BBWSM1213	BBWDM1214	12 - 13	12 - 14	205	218
BBWSM1214	BBWDM1415	12 - 14	14 - 15	220	235
BBWSM1314	BBWDM1417	13 - 14	14 - 17	220	260
BBWSM1415	BBWDM1617	14 - 15	16 - 17	235	260
BBWSM1417	BBWDM1719	14 - 17	17 - 19	235	292
BBWSM1516	BBWDM1819	15 - 16	18 - 19	240	292
BBWSM1617	BBWDM1921	16 - 17	19 - 21	240	318
BBWSM1719	BBWDM1922	17 - 19	19 - 22	250	318

PART NO.		mm		L (mm)	
45	75				
BBWSM1819	BBWDM2022	18 - 19	20 - 22	250	318
BBWSM1921	BBWDM2123	19 - 21	21 - 23	270	330
BBWSM1922	BBWDM2224	19 - 22	22 - 24	270	330
BBWSM2022	BBWDM2326	20 - 22	23 - 26	270	346
BBWSM2122	BBWDM2426	21 - 22	24 - 26	290	346
BBWSM2123	BBWDM2427	21 - 23	24 - 27	290	346
BBWSM2224	BBWDM2528	22 - 24	25 - 28	320	355
BBWSM2326	BBWDM2430	23 - 26	24 - 30	360	355
BBWSM2426	BBWDM2730	24 - 26	27 - 30	360	355
BBWSM2427	BBWDM3032	24 - 27	30 - 32	360	372
BBWSM2528	BBWDM3436A	25 - 28	34 - 36	370	440
BBWSM2730		27 - 30		380	
BBWSM2732		27 - 32		380	
BBWSM3032		30 - 32		380	
BBWSM3436		34 - 36		405	

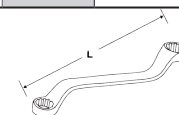



Double Flex Socket Wrench Set, 8pcs

BLPBWRES8

Packing: 1 (Set)

- Higher Torque – 15% to 20% more turning power with Flank Drive wrenching system
- Flexible sockets wrench provides speed and accessibility to work round corners
- 12 point socket end gives great grip at either end making sure there is no slipping when tightening and loosening
- Manufactured from chrome vanadium steel for strength and durability
- Full polished chrome finish easily wipes clean of oil and dirt
- 2 sizes in one wrench
- Supplied in a canvas tool pouch for neat and easy storage and transportation



PART NO.	mm	L (mm)
BLPBWREF67	6 - 7	185
BLPBWREF89	8 - 9	185
BLPBWREF1011	10 - 11	200
BLPBWREF1213	12 - 13	220

PART NO.	mm	L (mm)
BLPBWREF1415	14 - 15	242
BLPBWREF1617	16 - 17	254
BLPBWREF1819	18 - 19	275
BLPBWREF2123	21 - 23	305



Double Flex Socket Wrench

Packing: 10

- Higher Torque – 15% to 20% more turning power with Flank Drive wrenching system
- Flexible sockets wrench provides speed and accessibility to work round corners
- 12 point socket end gives great grip at either end making sure there is no slipping when tightening and loosening
- Manufactured from chrome vanadium steel for strength and durability
- Full polished chrome finish easily wipes clean of oil and dirt
- 2 sizes in one wrench



PART NO.	mm	L (mm)
BLPBWREF67	6 - 7	185
BLPBWREF89	8 - 9	185
BLPBWREF810	8 - 10	185
BLPBWREF1011	10 - 11	200
BLPBWREF1012	10 - 12	205
BLPBWREF1013	10 - 13	205
BLPBWREF1113	11 - 13	205
BLPBWREF1213	12 - 13	220
BLPBWREF1214	12 - 14	225
BLPBWREF1317	13 - 17	242

PART NO.	mm	L (mm)
BLPBWREF1415	14 - 15	242
BLPBWREF1417	14 - 17	244
BLPBWREF1617	16 - 17	254
BLPBWREF1719	17 - 19	260
BLPBWREF1819	18 - 19	275
BLPBWREF1922	19 - 22	300
BLPBWREF2022	20 - 22	305
BLPBWREF2123	21 - 23	305
BLPBWREF2427	24 - 27	335
BLPBWREF3032	30 - 32	345

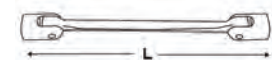

Double Open End Wrench Set, 12pcs

BDOEMTSET12

Packing: 6

- New high polish
- Manufactured from high grade steel alloy
- Features a Lifetime Warranty and exceeds ANSI Standards
- Set in pouch packaging



PART NO.	mm	L (mm)
BDOEMT67	6 - 7	126
BDOEMT89	8 - 9	145
BDOEMT1011	10 - 11	162
BDOEMT1213	12 - 13	181
BDOEMT1415	14 - 15	189
BDOEMT1617	16 - 17	198

PART NO.	mm	L (mm)
BDOEMT1819	18 - 19	198
BDOEMT2022	20 - 22	220
BDOEMT2123	21 - 23	242
BDOEMT2427	24 - 27	264
BDOEMT2528	25 - 28	287
BDOEMT3032	30 - 32	287

Double Open End Wrench

- Manufactured from high grade steel alloy
- Features a Lifetime Warranty and exceeds ANSI Standards

Packing: 6



PART NO.	mm	L (mm)
BDOEM67	6 - 7	125
BDOEM68	6 - 8	125
BDOEM89	8 - 9	135
BDOEM810	8 - 10	135
BDOEM1011	10 - 11	145
BDOEM1012	10 - 12	145
BDOEM1113	11 - 13	165
BDOEM1213	12 - 13	165
BDOEM1214	12 - 14	165
BDOEM1314	13 - 14	165
BDOEM1415	14 - 15	185
BDOEM1417	14 - 17	185
BDOEM1617	16 - 17	185
BDOEM1719	17 - 19	225
BDOEM1819	18 - 19	225
BDOEM1921	19 - 21	237

PART NO.	mm	L (mm)
BDOEM1922	19 - 22	237
BDOEM2022	20 - 22	255
BDOEM2123	21 - 23	255
BDOEM2224	22 - 24	255
BDOEM2326	23 - 26	295
BDOEM2426	24 - 26	295
BDOEM2427	24 - 27	295
BDOEM2528	25 - 28	334
BDOEM3032	30 - 32	368

PART NO.	mm	L (mm)
BDOE1012	5/16 - 3/8	5 5/16
BDOE1416	7/16 - 1/2	6 1/2
BDOE1820	9/16 - 5/8	7 9/32
BDOE2224	11/16 - 3/4	8 15/16

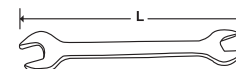



Flare Nut Wrench Set, 9pcs

BLPFNWS9

Packing: 1 (Set)

- Higher Torque – 15% to 20% more turning power with Flank Drive wrenching system
- Open side allows for easy access over tubing and lines
- Manufactured from chrome vanadium steel for strength and durability
- Full polished chrome finish easily wipes clean of oil and dirt
- Large hard stamped size markings allow for easy identification
- Supplied in a canvas tool pouch for neat and easy storage and transportation



PART NO.	mm	L (mm)
BLPFNM810	8 - 10	139
BLPFNM911	9 - 11	153
BLPFNM1012	10 - 12	153
BLPFNM1314	13 - 14	174
BLPFNM1517	15 - 17	195

PART NO.	mm	L (mm)
BLPFNM1618	16 - 18	213
BLPFNM1719	17 - 19	213
BLPFNM1921	19 - 21	228
BLPFNM2123	21 - 23	243



Flare Nut Wrench

Packing: 10

- Higher Torque – 15% to 20% more turning power with Flank Drive wrenching system
- Open side allows for easy access over tubing and lines
- Manufactured from chrome vanadium steel for strength and durability
- Full polished chrome finish easily wipes clean of oil and dirt
- Large hard stamped size markings allow for easy identification



PART NO.	mm	L (mm)
BLPFNM79	7 - 9	139
BLPFNM810	8 - 10	139
BLPFNM910	9 - 10	139
BLPFNM911	9 - 11	153
BLPFNM1011	10 - 11	153
BLPFNM1012	10 - 12	153
BLPFNM1112	11 - 12	153
BLPFNM1113	11 - 13	174
BLPFNM1213	12 - 13	174
BLPFNM1214	12 - 14	174
BLPFNM1314	13 - 14	174
BLPFNM1315	13 - 15	175
BLPFNM1415	14 - 15	175
BLPFNM1417	14 - 17	195

PART NO.	mm	L (mm)
BLPFNM1517	15 - 17	195
BLPFNM1618	16 - 18	213
BLPFNM1719	17 - 19	213
BLPFNM1819	18 - 19	213
BLPFNM1921	19 - 21	228
BLPFNM1922	19 - 22	228
BLPFNM2123	21 - 23	243
BLPFNM2224	22 - 24	243
BLPFNM2426	24 - 26	258
BLPFNM2427	24 - 27	258
BLPFNM2432	24 - 32	287
BLPFNM2528	25 - 28	297
BLPFNM3032	30 - 32	297
BLPFNM3641	36 - 41	317

WRENCHES Double Open End

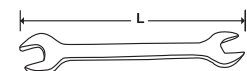

96

Water Pump Pulley Wrench

YA1350

Packing: 1

- Essential tool for preventing pulley damage when removing or installing bolts
- Fixed pin dimension for quick, easy installation
- Unique bend to clear engine compartment obstacles
- Wrench head shaped for generous clearance around the bolts



Fan Clutch Pulley Holder

YA6160

Packing: 1

- Removes and replaces the fan clutch on vehicles using "bolt on" water pump pulleys
- Reverse pulley holder for assembly operations



Chain Wrench

Packing: 6



Strap Wrench

Packing: 1

- Adjusts to fit any circumference or irregular shape
- Grip, loosen or tighten almost anything
- Won't scratch or damage surfaces
- Cushioned grip for maximum comfort
- Heavy duty construction for longer life
- Also available in set, PN: BLPSTWRKT



PART NO.	CHAIN LENGTH (inches)	CAPACITY (inches)	HANDLE LENGTH (inches)
CW12A	16	4	12
CW15A	19	5	15
CW24A	23	6	24

PART NO.	DIAMETER
BLPSTWR4	4" max
BLPSTWR6	6" max



Ratchet Combination Wrench Sets

Packing: 1

- Dual pawl ratcheting box end yields smooth operation and maximum strength
- 15° offset box head provides extra knuckle clearance
- 4.5° (5° on smaller wrenches) gear engagement means less movement to engage the next gear
- Inch scale laser etched on head face
- Ratcheting box is reversible
- Box end features the FLANK DRIVE® wrenching configuration for greater torque with less applied force
- Tough, durable nickel-chrome finish
- Meets or exceeds strength specifications in ASME B107.6

PART NO.	CONTENTS
BOERM712	8 to 19mm Ratchet Combination Wrench Set, 12pcs BOERM8 BOERM9 BOERM10 BOERM11 BOERM12 BOERM13 BOERM14 BOERM15 BOERM16 BOERM17 BOERM18 BOERM19
BOERM704	21 to 25mm Ratchet Combination Wrench Set, 4pcs BOERM21 BOERM22 BOERM24 BOERM25
BOER704	13/16" to 1" Ratchet Combination Wrench Set, 4 pcs BOER26 BOER28 BOER30 BOER32
BOER708	5/16" to 3/4" Ratchet Combination Wrench Set, 8 pcs BOER10 BOER12 BOER14 BOER16 BOER18 BOER20 BOER22 BOER24



Ratcheting Wrench Set, Flex Head, 12pcs

BOERMF712A

Packing: 1

PART NO.	CONTENTS
BOERMF712A	8 to 19mm Flexible Head Ratchet Combination Wrenches BOERMF8A BOERMF9A BOERMF10A BOERMF11A BOERMF12A BOERMF13A BOERMF14A BOERMF15A BOERMF16A BOERMF17A BOERMF18A BOERMF19A



Ratcheting Wrench Set, Flex Head, 8pcs

BOERF708A

Packing: 1

PART NO.	CONTENTS
BOERF708A	5/16" to 3/4" Flexible Head Ratchet Combination Wrenches BOERF10A BOERF12A BOERF14A BOERF16A BOERF18A BOERF20A BOERF22A BOERF24A



Ratchet Combination

Packing: 6

- Dual pawl ratcheting box end yields smooth operation and maximum strength
- 15° offset box head provides extra knuckle clearance
- 4.5° (5° on smaller wrenches) gear engagement means less movement to engage the next gear
- Inch scale laser etched on head face
- Ratcheting box is reversible
- Box end features the FLANK DRIVE® wrenching configuration for greater torque with less applied force
- Tough, durable nickel-chrome finish
- Meets or exceeds strength specifications in ASME B107.6



PART NO.	mm	A (mm)	B (mm)	L (mm)
BOERM6	6	6.6	3.6	114
BOERM7	7	6.6	3.9	125
BOERM8	8	6.5	4.0	135
BOERM9	9	7.4	4.0	150
BOERM10	10	8.0	5.0	160
BOERM11	11	8.5	5.5	170
BOERM12	12	9.0	5.5	175
BOERM13	13	10.0	6.3	180
BOERM14	14	10.0	6.5	190
BOERM15	15	11.0	7.0	200
BOERM16	16	11.0	7.0	210
BOERM17	17	12.0	7.0	230
BOERM18	18	12.0	8.0	240
BOERM19	19	12.9	8.7	250
BOERM21	21	13.7	9.4	266
BOERM22	22	14.5	9.4	286
BOERM24	24	15.5	11.2	305
BOERM25	25	15.5	11.2	327

PART NO.	inches	A (inches)	B (inches)	L (inches)
BOER8	1/4	1/4	5/32	4 1/2
BOER10	5/16	1/4	5/32	5 5/16
BOER12	3/8	5/16	3/16	6 5/16
BOER14	7/16	11/32	7/32	6 11/16
BOER16	1/2	13/32	1/4	7 1/16
BOER18	9/16	13/32	1/4	7 1/2
BOER20	5/8	7/16	9/32	8 1/4
BOER22	11/16	15/32	9/32	9 1/16
BOER24	3/4	1/2	11/32	9 13/16
BOER26	13/16	17/32	3/8	10 1/2
BOER28	7/8	9/16	3/8	11 1/4
BOER30	15/16	5/8	7/16	12
BOER32	1	5/8	7/16	12 7/8

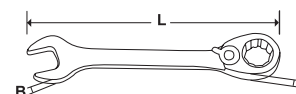

Ratchet Combination, Flex Head

Packing: 6

- Flex head pivots 90° in either direction
- Dual pawl reversible ratcheting box end
- Low profile easy action reverse lever won't get in your way
- Tough, durable nickel chrome finish
- Up to 80 gear teeth for ratcheting in tight areas



PART NO.	mm	A (mm)	B (mm)	L (mm)
BOERMF8A	8	6.5	4.0	142
BOERMF9A	9	7.4	4.0	152
BOERMF10A	10	8.0	5.0	162
BOERMF11A	11	8.5	5.5	172
BOERMF12A	12	9.0	5.5	180
BOERMF13A	13	10.0	6.3	188
BOERMF14A	14	10.0	6.5	196
BOERMF15A	15	11.0	7.0	204
BOERMF16A	16	11.0	7.0	214
BOERMF17A	17	12.0	7.0	228
BOERMF18A	18	12.0	8.0	242
BOERMF19A	19	12.9	8.7	256

PART NO.	II	A (inches)	B (inches)	L (inches)
BOERF10A	5/16	1/4	5/32	5 19/32
BOERF12A	3/8	5/16	3/16	6 3/8
BOERF14A	7/16	11/32	7/32	6 3/4
BOERF16A	1/2	13/32	1/4	7 13/32
BOERF18A	9/16	13/32	1/4	7 23/32
BOERF20A	5/8	7/16	9/32	8 7/16
BOERF22A	11/16	15/32	9/32	8 31/32
BOERF24A	3/4	1/2	11/32	10 1/16

Flexible Head Ratchet Combination Wrench

WRENCHES Ratchet Combination

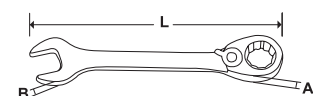

100

Ratcheting Wrench Sets, Short

Packing: 1



PART NO.	CONTENTS
BOERMS712	8 to 19mm Short Ratchet Combination Wrench Set, 12pcs BOERMS8 BOERMS9 BOERMS10 BOERMS11 BOERMS12 BOERMS13 BOERMS14 BOERMS15 BOERMS16 BOERMS17 BOERMS18 BOERMS19
BOERS708	5/16" to 3/4" Short Ratchet Combination Wrench Set, 8pcs BOERS10 BOERS12 BOERS14 BOERS16 BOERS18 BOERS20 BOERS22 BOERS24

Short Ratchet Combination

Packing: 6

- Dual pawl reversible ratcheting box end
- Low profile easy action reverse lever won't get in your way
- Up to 80 gear teeth for ratcheting in tight areas
- Tough, durable nickel chrome finish



PART NO.	mm	A (mm)	B (mm)	L (mm)
BOERMS8	8	6.5	4.0	90
BOERMS9	9	7.4	4.0	95
BOERMS10	10	8.0	5.0	100
BOERMS11	11	8.5	5.5	105
BOERMS12	12	9.0	5.5	110
BOERMS13	13	10.0	6.3	115
BOERMS14	14	10.0	6.5	120
BOERMS15	15	11.0	7.0	125
BOERMS16	16	11.0	7.0	128
BOERMS17	17	12.0	7.0	132
BOERMS18	18	12.0	8.0	138
BOERMS19	19	12.9	8.7	142

PART NO.	II	A (inches)	B (inches)	L (inches)
BOERS10	5/16	1/4	5/32	3 9/16
BOERS12	3/8	5/16	3/16	3 15/16
BOERS14	7/16	11/32	7/32	4 1/8
BOERS16	1/2	13/32	1/4	4 1/2
BOERS18	9/16	13/32	1/4	4 3/4
BOERS20	5/8	7/16	9/32	5 1/16
BOERS22	11/16	15/32	9/32	5 3/16
BOERS24	3/4	1/2	11/32	5 9/16

Ratcheting Wrench Set, Short Flex Head, 8pcs

Packing: 1



PART NO.	CONTENTS
BOERSF708	5/16" to 3/4" Short Flexible Ratchet Combination Wrench BOERSF10 BOERSF12 BOERSF14 BOERSF16 BOERSF18 BOERSF20 BOERSF22 BOERSF24

Short Flex Head Ratchet Combination

Packing: 6

- Flex head pivots 90° in either direction
- Dual pawl reversible ratcheting box end
- Up to 80 gear teeth for ratcheting in tight areas



PART NO.	mm	A (mm)	B (mm)	L (mm)
BOERMSF8	8	6.5	4.0	94
BOERMSF9	9	7.4	4.0	98
BOERMSF10	10	8.0	5.0	103
BOERMSF11	11	8.5	5.5	108
BOERMSF12	12	9.0	5.5	111
BOERMSF13	13	10.0	6.3	115
BOERMSF14	14	10.0	6.5	120
BOERMSF15	15	11.0	7.0	124
BOERMSF16	16	11.0	7.0	128
BOERMSF17	17	12.0	7.0	133
BOERMSF18	18	12.0	8.0	140
BOERMSF19	19	12.9	8.7	147

PART NO.	II	A (inches)	B (inches)	L (inches)
BOERSF10	5/16	1/4	5/32	3 11/16
BOERSF12	3/8	5/16	3/16	4 1/16
BOERSF14	7/16	11/32	7/32	4 1/4
BOERSF16	1/2	13/32	1/4	4 17/32
BOERSF18	9/16	13/32	1/4	4 23/32
BOERSF20	5/8	7/16	9/32	5 1/32
BOERSF22	11/16	15/32	9/32	5 1/4
BOERSF24	3/4	1/2	11/32	5 25/32

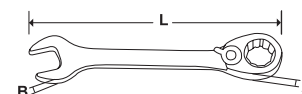

Single Direction Ratchet Combination

Packing: 10



PART NO.	mm	A (mm)	B (mm)	L (mm)
BLPGWM5.5	5.5	7	4.2	114
BLPGWM6	7	7	4.2	114
BLPGWM7	7	7	4.2	114
BLPGWM8	7	7	4.7	132
BLPGWM9	7	7	4.7	132
BLPGWM10	10	8.2	5.3	149
BLPGWM11	11	8.5	5.9	167
BLPGWM12	12	9.4	6.5	185
BLPGWM13	13	9.4	6.5	185
BLPGWM14	14	9.7	7.1	202
BLPGWM15	15	9.7	7.1	202
BLPGWM16	16	10.8	7.7	220
BLPGWM17	17	10.8	7.7	220
BLPGWM18	18	11.3	8.3	238
BLPGWM19	19	11.3	8.3	238
BLPGWM20	20	11.3	8.3	238
BLPGWM21	21	11.8	8.85	247
BLPGWM22	22	11.8	8.85	247
BLPGWM23	23	12.3	9.4	270
BLPGWM24	24	12.3	9.4	270
BLPGWM26	26	13.1	10.2	293

PART NO.	mm	A (mm)	B (mm)	L (mm)
BLPGWM27	27	13.1	10.2	293
BLPGWM30	30	14.1	11.2	322
BLPGWM32	32	15.8	12.4	388
BLPGWM34	34	15.8	12.4	388
BLPGWM36	36	17.8	13.9	456
BLPGWM38	38	17.8	13.9	456
BLPGWM40	40	20.15	16.15	503
BLPGWM41	41	20.15	16.15	503
BLPGWM42	42	20.15	16.15	503
BLPGWM44	44	22.6	18	540
BLPGWM45	45	22.6	18	540
BLPGWM46	46	22.6	18	540
BLPGWM48	48	25.5	20	580
BLPGWM50	50	25.5	20	580
BLPGWM55	55	28.5	22.3	618
BLPGWM57	57	28.5	22.3	618
BLPGWM58	58	31.6	23.6	658
BLPGWM60	60	31.6	23.6	658
BLPGWM65	65	34.7	26.1	698
BLPGWM70	70	37.9	28.6	738

Double Ring Ratcheting

Packing: 10



PART NO.	mm	A (mm)	L (mm)
BLPGWDM67	6 - 7	16.8	132
BLPGWDM89	8 - 9	20	150
BLPGWDM810	9 - 10	20 - 22	160
BLPGWDM1011	10 - 11	22 - 24	168
BLPGWDM1012	10 - 12	22 - 27.5	176
BLPGWDM1013	10 - 13	22 - 27.5	176
BLPGWDM1213	12 - 13	27.5	186
BLPGWDM1214	12 - 14	27.5 - 30.5	195
BLPGWDM1314	13 - 14	27.5 - 30.5	195

PART NO.	mm	A (mm)	L (mm)
BLPGWDM1415	14 - 15	30.5	204
BLPGWDM1417	14 - 17	33.5	222
BLPGWDM1617	16 - 17	33.5	222
BLPGWDM1719	17 - 19	33.5 - 36.5	229
BLPGWDM1819	18 - 19	36.5	240
BLPGWDM2022	20 - 22	36.5 - 40.5	258
BLPGWDM2224	22 - 24	45	276
BLPGWDM2324	23 - 24	45	276

WRENCHES Ratchet Combination

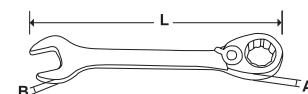



WRENCHES

Ratchet Combination / T-Shape

Ratcheting Wrench Set, Locking Flex Head, 12pcs

BOERMFLCG712

Packing: 1



PART NO.	CONTENTS
BOERMFLCG712	8 to 19mm Locking Flexible Head Ratchet Combination Wrench BOERMFLCG8 BOERMFLCG9 BOERMFLCG10 BOERMFLCG11 BOERMFLCG12 BOERMFLCG13 BOERMFLCG14 BOERMFLCG15 BOERMFLCG16 BOERMFLCG17 BOERMFLCG18 BOERMFLCG19

Ratcheting Wrench Set, Locking Flex Head, 8pcs

BOERFLCG708

Packing: 1



PART NO.	CONTENTS
BOERFLCG708	5/16" to 3/4" Locking Flexible Head Ratchet Combination Wrench BOERFLCG10 BOERFLCG12 BOERFLCG14 BOERFLCG16 BOERFLCG18 BOERFLCG20 BOERFLCG22 BOERFLCG24

Locking Flex Head Ratchet Combination

- Corrosive resistant bi-mold cushion grips for improved comfort and performance
- Wrenches have multiple locking head positions for easier access to tough to reach fasteners
- Long reach solid shank steel handle for improved reach and leverage
- Dual pawl reversible ratchet head
- Flex head pivots 90° in either direction

Packing: 6



PART NO.	mm	A (mm)	B (mm)	L (mm)
BOERMFLCG8	8	6.55	32	228
BOERMFLCG9	9	7.45	34	229
BOERMFLCG10	10	8.05	38	233
BOERMFLCG11	11	8.55	40	235
BOERMFLCG12	12	9.05	42	285
BOERMFLCG13	13	10.05	45	287
BOERMFLCG14	14	10.05	48	289
BOERMFLCG15	15	11.05	52	293
BOERMFLCG16	16	11.05	54	347
BOERMFLCG17	17	12.05	56	348
BOERMFLCG18	18	12.05	60	352
BOERMFLCG19	19	12.95	64	354

PART NO.	II	A (inches)	B (inches)	L (inches)
BOERFLCG10	5/16	1/4	1 1/4	9
BOERFLCG12	3/8	5/16	1 1/2	8 1/4
BOERFLCG14	7/16	11/32	1 9/16	9 19/32
BOERFLCG16	1/2	13/32	1 25/32	11 9/32
BOERFLCG18	9/16	13/32	1 29/32	11 3/8
BOERFLCG20	5/8	7/16	2 1/8	13 21/32
BOERFLCG22	11/16	15/32	2 7/32	13 23/32
BOERFLCG24	3/4	1/2	2 17/32	13 15/16

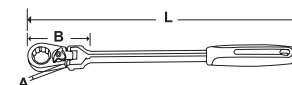

Ratcheting Box Wrench Sets, 5pcs

Packing: 1



PART NO.	CONTENTS
RBZM605	7mm - 8mm to 15mm -17mm Ratcheting Box Wrench Set, 5pcs RBZM78 RBZM910 RBZM1112 RBZM1314 RBZM1517
RBZ605	1/4" - 5/16" to 3/4" - 7/8" Ratcheting Box Wrench Set, 5pcs RBZ810 RBZ1214 RBZ1618 RBZ2022 RBZ2428

Ratcheting Box

Packing: 1

- Latch-on head keeps wrench on fastener
- Ring prevents nut/fastener head from sliding through wrench



PART NO.	mm	A (mm)	L (mm)
RBZM78	7 - 8	15.1 - 17.1	114
RBZM910	9 - 10	20.4 - 22.6	140
RBZM1112	11 - 12	25.8 - 29.4	175
RBZM1314	13 - 14	25.8 - 29.4	175
RBZM1517	15 - 17	32.9 - 36.5	206
RBZM1618	16 - 18	32.9 - 36.5	206
RBZM1921	19 - 21	35.7 - 40.1	235

PART NO.	II	A (inches)	L (inches)
RBZ810	1/4 - 5/16	3/8	4 1/2
RBZ1214	3/8 - 7/16	3/8	5 7/2
RBZ1618	1/2 - 9/16	1/2	6 1/8
RBZ2022	5/8 - 11/16	1/2	9 1/4
RBZ2428	3/4 - 7/8	1/2	9 1/4

WRENCHES

Ratchet Combination / T-Shape



Reversible Ratcheting Wrench Set, 2pcs

BLPMSWRH2S

Packing: 1 (Set)

- Each wrench fits more than 28 sizes
- Compact reversible switch
- 72 teeth provides 50 ratcheting leverage
- Chrome vanadium steel for strength and durability



Size (mm/inches)	Size (mm/inches)	Size (mm/inches)	Size (mm/inches)
8 5/16	7 9/32	8	E10
10 3/8	- 11/32	10	E12
11 7/16	9 3/8	11	E14
12 1/2	11 7/16	13	E16
14 9/16	12 15/32	14	E18
16 5/8	13 17/32	16	E20
17 11/16	14 9/16	17	E22
19 3/4	16 5/8	19	E24

T-Shape Speeder Wrench

Packing: 1

- Speedy socket wrench, convenience for use
- Magnetic inset for convenience

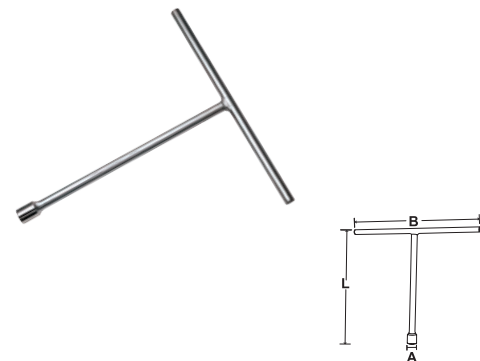

PART NO.	A (mm)	B (mm)	L (mm)
BPTHM08	8	200	250
BPTHM09	9	200	250
BPTHM10	10	200	250
BPTHM11	11	200	250
BPTHM12	12	250	250
BPTHM13	13	250	300
BPTHM14	14	250	300



Folding Hex Key Set, 8pcs

BLFHS8

Packing: 1

- Material: S2
- Finish: Satin



PART NO.	CONTENTS
BLFHS8	Hex Key Sizes: 1.5, 2, 2.5, 3, 4, 5, 6, 8mm

T-Hex Ball End Key Set, 8pcs

BLWBS8

Packing: 1

- Set in metal stand
- Material: S2
- Finish: Satin



PART NO.	CONTENTS
BLWBS8	T-Hex Ball End Key BLWTBM2 BLWTBM2.5 BLWTBM3 BLWTBM4 BLWTBM5 BLWTBM6 BLWTBM8 BLWTBM10

T-Hex Ball End Key

- Material: S2
- Finish: Satin

Packing: 1



PART NO.	mm	A (mm)	L (mm)
BLWTBM2	2	83	13
BLWTBM2.5	2.5	83	13
BLWTBM3	3	83	13
BLWTBM4	4	83	13
BLWTBM5	5	83	13
BLWTBM6	6	134	15
BLWTBM8	8	134	15
BLWTBM10	10	134	15

T-Hex Key

- Ergonomical handle for a better grip
- Made from high torque steel

Packing: 6



PART NO.	mm	A (mm)	L (mm)
BTWM1.5	1.5	83	122
BTWM2.5	2.5	83	122
BTWM3	3	83	122
BTWM4	4	83	122
BTWM5	5	83	122
BTWM6	6	134	186
BTWM7	7	134	186
BTWM8	8	134	186

L-Hex Short Arm Key Set, 9pcs

BLFHKS9

Packing: 1

- Set in plastic holder
- Material: S2
- Finish: Satin



PART NO.	CONTENTS
BLFHKS9	L-Hex Short Arm Key BLWSM1.5 BLWSM2 BLWSM2.5 BLWSM3 BLWSM4 BLWSM5 BLWSM6 BLWSM8 BLWSM10

L-Hex Long Arm Key Set, 9pcs

BLWHKLS9

Packing: 1

- Set in plastic holder
- Material: S2
- Finish: Satin



PART NO.	CONTENTS
BLWHKLS9	L-Hex Long Arm Key BLWLM1.5 BLWLM2 BLWLM2.5 BLWLM3 BLWLM4 BLWLM5 BLWLM6 BLWLM8 BLWLM10



L-Hex Extra Long Arm Key Set, 9pcs

BLWHKELS9

Packing: 1

- Set in plastic holder
- Material: S2
- Finish: Satin



PART NO.	CONTENTS		
BLWHKELS9	L-Hex Extra Long Arm Key		
	BLWXM1.5	BLWXM2	BLWXM2.5
	BLWXM3	BLWXM4	BLWXM5
	BLWXM6	BLWXM8	BLWXM10

L-Hex Long Ball End Key Set, 9pcs

BLWSM9

Packing: 1

- Set in plastic holder
- Made from high torque steel
- Ball hex allows angle entry



PART NO.	CONTENTS		
BLWSM9	L-Hex Long Ball End Key		
	BLWLB1.5	BLWLB2	BLWLB2.5
	BLWLB3	BLWLB4	BLWLB5
	BLWLB6	BLWLB8	BLWLB10

L-Hex Extra Long Ball End Key Set, 9pcs

BLHKELBS9

Packing: 1

- Set in plastic holder
- Material: S2
- Finish: Satin



PART NO.	CONTENTS		
BLHKELBS9	L-Hex Extra Long Ball End Key		
	BLWXLB1.5	BLWXLB2	BLWXLB2.5
	BLWXLB3	BLWXLB4	BLWXLB5
	BLWXLB6	BLWXLB8	BLWXLB10

L-Torx Key Set, 9pcs

BLWTS9

Packing: 1

- Set in plastic holder
- Made from high torque steel



#	A (mm)	L (mm)
T10	17	86
T15	18	90
T20	19	95
T25	20	100
T27	21	105
T30	24	114
T40	26	124
T45	29	133
T50	32	152

L-Torx Long Arm Key Set, 9pcs

BLWTL9

Packing: 1

- Set in plastic holder
- Material: S2
- Finish: Satin



PART NO.	CONTENTS		
BLWTL9	L-Torx Long Arm Key		
	BLWTL10	BLWTL15	BLWTL20
	BLWTL25	BLWTL27	BLWTL30
	BLWTL40	BLWTL45	BLWTL50

L-Torx Extra Long Key Set, 9pcs

BLWTES9

Packing: 1

- Set in plastic holder
- Material: S2
- Finish: Satin



PART NO.	CONTENTS		
BLWTES9	L-Torx Extra Long Key Sizes: T10, T15, T20, T25, T27, T30, T40, T45, T50		

L-Hex Key

- Made from high torque steel
- Heavy duty usage
- Satin finish



PART NO.	mm	A (mm)	L (mm)
BLWM1.5	1.5	13.5	77
BLWM2	2	15.5	82
BLWM2.5	2.5	17.5	88.5
BLWM3	3	19	98.5
BLWM4	4	24	104
BLWM5	5	27	116
BLWM6	6	31	138
BLWM8	8	35	158
BLWM10	10	39	167
BLWM11	11	42	190
BLWM12	12	44	209
BLWM13	13	50	220
BLWM14	14	54.5	233
BLWM15	15	56.5	237
BLWM16	16	58.5	240
BLWM17	17	61.5	246
BLWM18	18	64.5	261
BLWM19	19	68.5	276

L-Hex Short Arm Key

- Material: S2
- Finish: Satin



PART NO.	mm	A (mm)	L (mm)
BLWSM1.5	1.5	15	46
BLWSM2	2	18	52
BLWSM2.5	2.5	20	58
BLWSM3	3	23	66
BLWSM4	4	29	74
BLWSM5	5	33	85
BLWSM6	6	38	96
BLWSM8	8	44	108
BLWSM10	10	50	122

L-Hex Long Arm Key

- Material: S2
- Finish: Satin



PART NO.	mm	A (mm)	L (mm)
BLWLM1.5	1.5	15	78
BLWLM2	2	17.5	84
BLWLM2.5	2.5	20	91
BLWLM3	3	22	102
BLWLM4	4	28	108
BLWLM5	5	32	121
BLWLM6	6	37	144
BLWLM8	8	43	166
BLWLM10	10	49	177

L-Hex Extra Long Arm Key

- Material: S2
- Finish: Satin



PART NO.	mm	A (mm)	L (mm)
BLWXM1.5	1.5	15	91
BLWXM2	2	17	101
BLWXM2.5	2.5	20	114
BLWXM3	3	22	128
BLWXM4	4	28	143
BLWXM5	5	32	164
BLWXM6	6	37	185
BLWXM8	8	43	207
BLWXM10	10	49	233



L-Hex Long Ball End Key

- Material: S2
- Finish: Satin



PART NO.	mm	A (mm)	L (mm)
BLWLB1.5	1.5	15	78
BLWLB2	2	17.5	84
BLWLB2.5	2.5	20	91
BLWLB3	3	22	102
BLWLB4	4	28	108
BLWLB5	5	32	121
BLWLB6	6	37	144
BLWLB8	8	43	166
BLWLB10	10	49	177

L-Hex Extra Long Ball End Key

- Material: S2
- Finish: Satin



PART NO.	mm	A (mm)	L (mm)
BLWXLB1.5	1.5	15	91
BLWXLB2	2	17	101
BLWXLB2.5	2.5	20	114
BLWXLB3	3	22	128
BLWXLB4	4	28	143
BLWXLB5	5	32	164
BLWXLB6	6	37	185
BLWXLB8	8	43	207
BLWXLB10	10	49	233

L-Torx Short Arm Key

- Material: S2
- Finish: Satin



PART NO.	#	A (mm)	L (mm)
BLWT9	T9	19	51
BLWT10	T10	20	54
BLWT15	T15	21	57
BLWT20	T20	23	61
BLWT25	T25	24	65
BLWT27	T27	26	69
BLWT30	T30	29	75
BLWT40	T40	33	83

L-Torx Long Arm Key

- Material: S2
- Finish: Satin



PART NO.	#	A (mm)	L (mm)
BLWTL9	T9	19	85
BLWTL10	T10	20	89
BLWTL15	T15	21	93
BLWTL20	T20	23	99
BLWTL25	T25	24	104
BLWTL27	T27	26	110
BLWTL30	T30	29	119
BLWTL40	T40	33	131

PLIERS & CUTTERS

Superior Comfort, Gripping & Cutting



Blue-Point[®]



Combination Pliers

1 Differential jaws for a more secure grip



2 Precise machined joint for ease of use and longer life



3 Dual compound soft grip handles provide good grip and comfort



4 Tougher steel for cutting harder and thicker wire, laser sharpened & treated cutting edge for less cutting effort



5 High leverage grip for tubular gripping applications



Pliers Set, Standard, 5pcs

BPL501

Packing: 6 (Set)

- Storage tray packaging



PART NO.	CONTENTS	JAW CAPACITY (inches)	LENGTH (inches)
B48CPAP	Slip Joint Pliers	2 3/32	8 13/32
B58HLPAP	Lineman's Pliers	1 1/2	8 31/32
B96CPAP	Long Nose Pliers	2 1/32	6 5/16
BAWP100AP	Adjustable Joint Pliers	1 3/8	10 5/32
B87CPAP	Diagonal Cutters	31/32	6 19/32

Pliers Set, Dipped Grips, 8pcs

BDGPL800

Packing: 6 (Set)

- Storage tray packaging



PART NO.	CONTENTS	JAW CAPACITY (inches)	LENGTH (inches)
BDGAWP100Z	Adjustable Joint Pliers	1 3/4	10
BDG48CPZ	Slip Joint Pliers	1 27/32	8
BDG98CPZ	Needle Nose Pliers	3	8
BDG9845CPZ	45° Bent Nose Pliers	2 13/16	7 3/4
BDG57CPZ	Lineman's Pliers	1 1/4	7 1/2
BDGEC7Z	End Cutter	7/16	7
BDG86CPZ	Diagonal Cutter	21/32	6 1/2
BDG88CPZ	Diagonal Cutter	15/16	8 1/8

Pliers Set, Standard, 7pcs

BDGCPL700

Packing: 6 (Set)

- Comes in a compact pouch, easy storage and portable
- Pouch design allows flexibility in storage of different pliers
- Dipped grips deliver optimal comfort during high strength gripping
- Drop forged chrome vanadium steel and fine polished



PART NO.	CONTENTS	JAW CAPACITY (inches)	LENGTH (inches)
BDG98CPZ	Needle Nose Pliers	3	8
BDG88CPZ	Diagonal Cutter	15/16	8
BDG45CMP	Mini Combination Pliers	1	4.5
BDG95CLMP	Mini Needle Nose Pliers	2 1/16	6
BDG85CTMP	Mini Thin Diagonal Nose Pliers	23/32	4.5
BDG945CMP	Mini 45° Bent Nose Pliers	1	4.5
BDG48CPZ	Slip Joint Pliers	1 27/32	8

Pliers Set, Long Reach, 3pcs

BDGPL300LR

Packing: 6 (Set)

- Storage tray packaging



PART NO.	CONTENTS	JAW CAPACITY (inches)	LENGTH (inches)
BDG311CPZ	Diagonal Cutters	1 9/16	11
BDG91145CPZ	45° Bent Nose Pliers	3 3/16	11
BDG911CPZ	Needle Nose Pliers	3 9/16	11

Pliers Set, Extra Long Reach, 2pcs

BDGPL200XLR

Packing: 6 (Set)

- Double dipped grips offer increased comfort and control during use
- Extra length provides additional access to difficult reach areas
- Corrosion resistant finish
- Storage tray packaging



PART NO.	CONTENTS	JAW CAPACITY (inches)	LENGTH (inches)
BDG91645CPZ	45° Bent Nose Pliers	3 3/16	16
BDG916CPZ	Needle Nose Pliers	3 9/16	16

Pliers Set, Extended Reach Hose Grip, 3pcs

BDGPL300HG

Packing: 6 (Set)

- Double dipped grips offer increased comfort and control during use
- Extra length provides additional access to difficult reach areas
- Leaf spring improve maneuverability
- Corrosion resistant finish



PART NO.	CONTENTS	JAW CAPACITY (inches)	LENGTH (inches)
BDGPL410HGZ	Small Hose Grip Pliers	2 1/4	11
BDGPL411HGZ	Medium Hose Grip Pliers	2 1/4	11
BDGPL412HGZ	Large Hose Grip Pliers	2	11

Pliers Set, Miniature, 8pcs

BDGMPL845

Packing: 6 (Set)

- Comes in a compact pouch, easy storage and portable
- Pouch design allows flexibility in storage of different pliers
- Dipped grips deliver optimal comfort during high strength gripping
- Drop forged chrome vanadium steel and fine polished



PART NO.	CONTENTS	JAW CAPACITY (inches)	LENGTH (inches)
BDG45CMP	Mini Combination Pliers	1	4.5
BDG85CMP	Mini Diagonal Nose Pliers	21/32	4.5
BDG85CTMP	Mini Thin Diagonal Nose Pliers	23/32	4.5
BDG945CMP	Mini 45° Bent Nose Pliers	1	4.5
BDG65CMP	Mini Flat Nose Pliers	1 5/32	4.5
BDG95CMP	Mini Long Nose Pliers	4 7/8	4.5
BDG95CLMP	Mini Needle Nose Pliers	2 1/16	6
BDGMPEC5	Mini End Cutters	4 1/32	4.5

Pliers Set, Miniature, 10pcs

BMPL1000

Packing: 6 (Set)

- Storage tray packaging



PART NO.	CONTENTS	JAW CAPACITY (inches)	LENGTH (inches)
B45CMPAP	Mini Combination Pliers	1	4 11/16
B65CMPAP	Mini Duck Bill Pliers	1 5/32	4 7/8
B75CMPAP	Mini Round Nose Pliers	1 5/32	5
B85CMPAP	Mini Diagonal Cutter	21/32	4 11/32
B85CTMPAP	Mini Thin Diagonal Cutter	23/32	4 5/8
B945CMPAP	Mini 45° Bent Nose Pliers	1	4 11/16
B95CMPAP	Mini Long Nose Pliers	1 1/8	4 7/8
B95CLMPAP	Mini Needle Nose Pliers	2 1/16	5 25/32
B960CMPAP	Mini 60° Bent Nose Pliers	15/16	4 11/16
BMPEC5AP	Mini End Cutter	5/16	4 1/32

Pliers Set, Miniature Long Reach, 4pcs

BDGPL400LMP

Packing: 6 (Set)

- Chrome nickel finish prevents against rust and corrosion
- Cushioned grips offer comfort during extended use
- Vinyl grips provide easy clean-up and durability
- Pliers exceed ANSI standards



PART NO.	CONTENTS	JAW CAPACITY (inches)	LENGTH (inches)
BDG96LMPZ	Mini Long Nose Pliers	1 5/16	6
BDG97LMPZ	Mini Needle Nose Pliers	2 13/32	7
BDG9645LMPZ	Mini 45° Bent Nose Pliers	1 7/32	6
BDG86LMPZ	Mini Diagonal Cutters	3/4	5 1/2

Slip Joint Pliers

BDG48CPZ

Packing: 6

- Dipped grip handles for easy cleaning
- Heat treated hardened cutting edge
- Drop forged chrome/nickel alloy is fine polished for corrosion resistant finish



PART NO.	JAW CAPACITY (inches)	LENGTH (inches)
BDG48CPZ	1 27/32	8

Combination Pliers

Packing: 6

- Dipped grip handles for easy cleaning
- Laser hardened cutting edge
- Drop forged chrome/nickel alloy is fine polished for corrosion resistant finish



PART NO.	DESCRIPTION	JAW CAPACITY (inches)	LENGTH (inches)
BDG57CPZ	Combination Pliers	1 1/4	7 1/2
BDGCB8K	Combination Pliers	7/8	8
BDGCB9HK	Combination Pliers High Leveratge	7/8	9

Adjustable Joint Pliers

BDGAWP100Z

Packing: 6

- Dipped grip handles for easy cleaning
- Drop forged chrome/nickel alloy is fine polished for corrosion resistant finish



PART NO.	JAW CAPACITY (inches)	LENGTH (inches)
BDGAWP100Z	1 3/4	10

Screw Removal Pliers
Specially Designed Jaws For
Gripping Damaged Screws

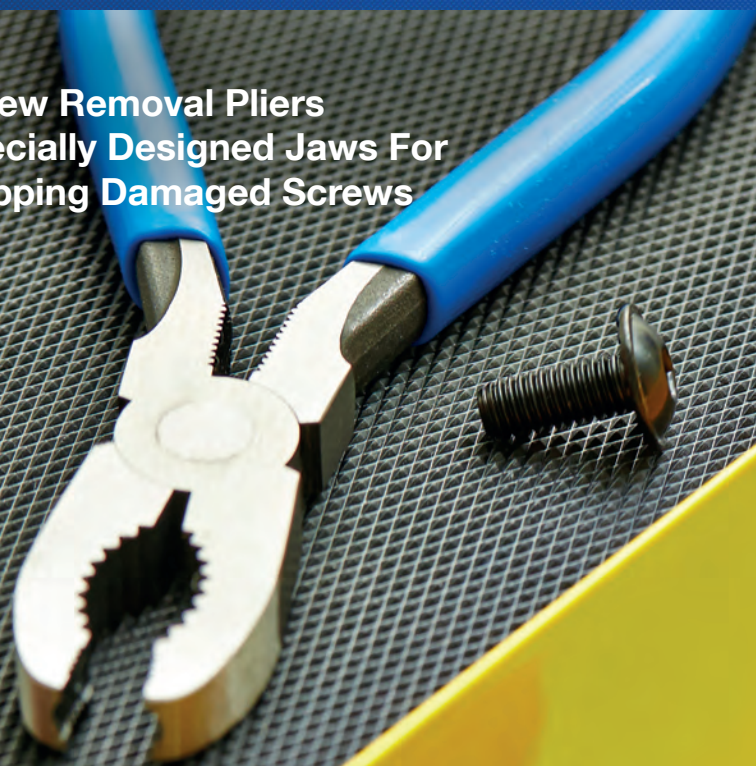

Screw Removal Pliers

BSP6

Packing: 6

- Jaws shaped specially for removing screws



PART NO.	JAW CAPACITY (inches)	LENGTH (inches)
BSP6	7/8	6

45° Bent Nose Pliers

BDG9845CPZ

Packing: 6

- Dipped grip handles for easy cleaning
- Laser hardened cutting edge
- Drop forged chrome/nickel alloy is fine polished for corrosion resistant finish



PART NO.	JAW CAPACITY (inches)	LENGTH (inches)
BDG9845CPZ	2 13/16	8

Long Nose Pliers

BDGLN6K

Packing: 6

- Dipped grip handles for easy cleaning
- Laser hardened cutting edge
- Drop forged chrome/nickel alloy is fine polished for corrosion resistant finish



PART NO.	JAW CAPACITY (inches)	LENGTH (inches)
BDGLN6K	1	6

Needle Nose Pliers

BDG98CPZ

Packing: 6

- Dipped grip handles for easy cleaning
- Laser hardened cutting edge
- Drop forged chrome/nickel alloy is fine polished for corrosion resistant finish



PART NO.	JAW CAPACITY (inches)	LENGTH (inches)
BDG98CPZ	3	8

Diagonal Cutters

Packing: 6

- Dipped grip handles for easy cleaning
- Laser hardened cutting edge
- Drop forged chrome/nickel alloy is fine polished for corrosion resistant finish



PART NO.	JAW CAPACITY (inches)	LENGTH (inches)
BDG86CPZ	21/32	6 1/2
BDG88CPZ	15/16	8 1/8
BDGCT6K	7/16	6

End Cutters

BDGEC7Z

Packing: 6

- Dipped grip handles for easy cleaning
- Drop forged chrome/nickel alloy is fine polished for corrosion resistant finish



PART NO.	JAW CAPACITY (inches)	LENGTH (inches)
BDGEC7Z	1/2	7

Plastic Cutters

BPC6

Packing: 6

- Flushed cutting edge for perfect cuts
- Thin cutting edge for precise trimming
- Laser hardened cutting edge



PART NO.	LENGTH (inches)
BPC6	6

Cable Diagonal Cutters

BDGCT6W

Packing: 6

- Diagonal cutter with holes for stripping cable
- Laser hardened cutting edge



PART NO.	LENGTH (inches)
BDGCT6W	6

Cable Cutters

Packing: 6

- Special flip over handle design allows tool to be used for slicing cable sleeve
- Drop forged chrome/nickel alloy is fine polish for corrosion resistant finish
- Precise machined joint for ease of use and longer life
- For cutting cables only



PART NO.	LENGTH (inches)
BCC6HD	6
BCC8HD	8
BCC10HD	10

High Leverage Diagonal Cutters

Packing: 6

- High leverage design delivers superior crimping and cutting force
- Laser hardened cutting edge
- Dual compound soft grip handles provide good grip and comfort
- Precise machined joint for ease of use and longer life
- Drop forged chrome/nickel alloy is fine polished for corrosion resistant finish



PART NO.	LENGTH (inches)
BCT6HD	6
BCT7HD	7
BCT8HD	8

Diagonal Cutters

1 Corrosion Resistant Finish

Drop forged chrome/ nickel alloy is fine polished for corrosion resistant finish



2 Laser Hardened Cutting Edge

Tougher steel for cutting harder and thicker wire, laser sharpened & treated cutting edge for less cutting effort



3 Designed For Comfort

Soft grip handles provide comfort and control



High Leverage Combination Pliers

Packing: 6

- High leverage design delivers superior crimping and cutting force
- Laser hardened cutting edge
- Dual compound soft grip handles provide good grip and comfort
- Precise machined joint for ease of use and longer life
- Drop forged chrome/nickel alloy is fine polished for corrosion resistant finish



PART NO.	LENGTH (inches)
BCB6HD	6
BCB7HD	7
BCB9HD	9

High Leverage Long Nose Pliers

Packing: 6

- High leverage design delivers superior crimping and cutting force
- Laser hardened cutting edge
- Dual compound soft grip handles provide good grip and comfort
- Precise machined joint for ease of use and longer life
- Drop forged chrome/nickel alloy is fine polished for corrosion resistant finish



PART NO.	LENGTH (inches)
BLN6HD	6
BLN7HD	7
BLN8HD	8

Combination Pliers

Packing: 6

- Dual compound soft grip handles provide good grip and comfort
- Laser hardened cutting edge
- Drop forged chrome/nickel alloy is fine polished for corrosion resistant finish



PART NO.	JAW CAPACITY (inches)	LENGTH (inches)
B58HLPAP	1 1/2	8 31/32
BDMCB6	5/8	6
BDMCB7	5/8	7
BDMCB8	7/8	8

Long Nose Pliers

Packing: 6

- Dual compound soft grip handles provide good grip and comfort
- Laser hardened cutting edge
- Drop forged chrome/nickel alloy is fine polished for corrosion resistant finish



PART NO.	JAW CAPACITY (inches)	LENGTH (inches)
B96CPAP	2 1/32	6 5/16
BDMLN6	1	6
BDMLN8	1 1/8	8

Adjustable Joint Pliers

BDMAJ10

Packing: 6

- Dual compound soft grip handles provide good grip and comfort
- Drop forged chrome/nickel alloy is fine polished for corrosion resistant finish



PART NO.	JAW CAPACITY (inches)	LENGTH (inches)
BDMAJ10	1 11/16	10

Slip Joint Pliers

B48CPAP

Packing: 6

- Dual compound soft grip handles provide good grip and comfort
- Drop forged chrome/nickel alloy is fine polished for corrosion resistant finish



PART NO.	JAW CAPACITY (inches)	LENGTH (inches)
B48CPAP	2 3/32	8 13/32

BAWP100AP

Packing: 6



PART NO.	JAW CAPACITY (inches)	LENGTH (inches)
BAWP100AP	1 3/8	10 5/32



Diagonal Cutters

Packing: 6

- Dual compound soft grip handles provide good grip and comfort
- Laser hardened cutting edge
- Drop forged chrome/nickel alloy is fine polished for corrosion resistant finish



PART NO.	JAW CAPACITY (inches)	LENGTH (inches)
B87CPAP	31/32	6 19/32
BDMCT5	5/16	5
BDMCT6	7/16	6
BDMCT7	1/2	7

Miniature Thin Diagonal Cutters

Packing: 6

- Dual compound soft grip handles provide good grip and comfort
- Drop forged chrome/nickel alloy is fine polished for corrosion resistant finish



PART NO.	JAW CAPACITY (inches)	LENGTH (inches)
B85CTMPAP	23/32	4 5/8

Miniature Cutters

Packing: 6

- Dual compound soft grip handles provide good grip and comfort
- Laser hardened cutting edge
- Drop forged chrome/nickel alloy is fine polished for corrosion resistant finish



PART NO.	JAW CAPACITY (inches)	LENGTH (inches)
B85CMPAP	21/32	4 11/32

Miniature Combination Pliers

Packing: 6

- Dual compound soft grip handles provide good grip and comfort
- Laser hardened cutting edge
- Drop forged chrome/nickel alloy is fine polished for corrosion resistant finish



PART NO.	JAW CAPACITY (inches)	LENGTH (inches)
B45CMPAP	1	4 11/16

Miniature Round Nose Pliers

Packing: 6

- Dual compound soft grip handles provide good grip and comfort
- Drop forged chrome/nickel alloy is fine polished for corrosion resistant finish



PART NO.	JAW CAPACITY (inches)	LENGTH (inches)
B75CMPAP	1 5/32	5

Miniature Long Nose Pliers

B95CMPAP

Packing: 6

- Dual compound soft grip handles provide good grip and comfort
- Laser hardened cutting edge
- Drop forged chrome/nickel alloy is fine polished for corrosion resistant finish



PART NO.	JAW CAPACITY (inches)	LENGTH (inches)
B95CMPAP	1 1/8	4 7/8

Miniature Curved Long Nose Pliers

B945CMPAP

Packing: 6

- Dual compound soft grip handles provide good grip and comfort
- Drop forged chrome/nickel alloy is fine polished for corrosion resistant finish



PART NO.	JAW CAPACITY (inches)	LENGTH (inches)
B945CMPAP	1	4 11/16

Miniature 60° Bent Nose Pliers

B960CMPAP

Packing: 6

- Dual compound soft grip handles provide good grip and comfort
- Drop forged chrome/nickel alloy is fine polished for corrosion resistant finish



PART NO.	JAW CAPACITY (inches)	LENGTH (inches)
B960CMPAP	15/16	4 11/16

Miniature Needle Nose Pliers

B95CLMPAP

Packing: 6

- Dual compound soft grip handles provide good grip and comfort
- Drop forged chrome/nickel alloy is fine polished for corrosion resistant finish



PART NO.	JAW CAPACITY (inches)	LENGTH (inches)
B95CLMPAP	2 1/16	5 25/32

Miniature Duck Bill Pliers

B65CMPAP

Packing: 6

- Dual compound soft grip handles provide good grip and comfort
- Drop forged chrome/nickel alloy is fine polished for corrosion resistant finish



PART NO.	JAW CAPACITY (inches)	LENGTH (inches)
B65CMPAP	1 5/32	4 7/8

Miniature Pincers

BMPEC5AP

Packing: 6

- Dual compound soft grip handles provide good grip and comfort
- Drop forged chrome/nickel alloy is fine polished for corrosion resistant finish



PART NO.	JAW CAPACITY (inches)	LENGTH (inches)
BMPEC5AP	5/16	4 1/32

Locking Pliers, Sheet Metal

VGP12808

Packing: 1

- Wide jaws allow clamping, bending, forming and crimping of sheet metal without gripping effort
- E-coat provides extra resistance against corrosion and welding splatter
- Quality cold-rolled steel ensures years of service
- Drop forged jaws ensure a tough, durable tool
- Smooth rounded edges allow comfortable handling and reduce risk of injury
- Spring-loaded release lever permits quick "NO PINCH" release even when tool is firmly locked
- Piano wire spring provides smooth jaw opening
- Adjustment bolt features deep knurl to accommodate greasy hands
- Locking nut allows setting for repetitive jobs
- Drilled (not punched) holes in mobile jaw ensure maximum bearing with rivets for smooth action
- Large diameter rivets add strength and durability



PART NO.	JAW CAPACITY (inches)	LENGTH (inches)
VGP12808	1 3/4	8

Locking Pliers, U-Clamp

VGP12509

Packing: 1

- U-shaped jaws allow access and perfect visibility when welding
- E-coat provides extra resistance against corrosion and welding splatter
- Quality cold-rolled steel ensures years of service
- Drop forged jaws ensure a tough, durable tool
- Smooth rounded edges allow comfortable handling and reduce risk of injury
- Spring-loaded release lever permits quick "NO PINCH" release even when tool is firmly locked
- Piano wire spring provides smooth jaw opening
- Adjustment bolt features deep knurl to accommodate greasy hands
- Locking nut allows setting for repetitive jobs
- Drilled (not punched) holes in mobile jaw ensure maximum bearing with rivets for smooth action
- Large diameter rivets add strength and durability



PART NO.	JAW CAPACITY (inches)	LENGTH (inches)
VGP12509	2 5/16	9

Locking Pliers, C-Clamp

- Quick and easy handling clamps for autobody and metal fabrication applications
- Spring loaded release lever permits quick "NO PINCH" release even when tool is firmly locked
- Locking nut allows setting for repetitive jobs

Packing: 1



PART NO.	DESCRIPTION	JAW CAPACITY (inches)	LENGTH (inches)
VGP12406	Standard Tip	2 5/16	6
VGP12412		3 5/16	12
VGP12418		10 1/4	18
VGP12424		15 11/16	24

PART NO.	DESCRIPTION	JAW CAPACITY (inches)	LENGTH (inches)
VGP22406	Swivel Tip	1 5/16	6
VGP22412		3 15/16	12
VGP22418		9 7/16	18
VGP22424		15 11/16	24

Locking Pliers, Chain Style

VGP18110

Packing: 1

- Wraps around and holds irregular shaped objects like oil filters and mufflers quickly and easily



PART NO.	CHAIN CAPACITY (inches)	HANDLE LENGTH (inches)
VGP18110	up to 6 9/32	9 27/32

Locking Pliers, Straight Jaws

Packing: 6

- Exceeds ASME specification
- Straight jaws with maximum contact area
- Nickel plated to resist corrosion
- Convenient one hand release lever



PART NO.	JAW CAPACITY (inches)	LENGTH (inches)
BDGLP75SAP	1 5/16	7
BDGLP10SAP	1 3/4	10

Locking Pliers, Straight Jaws, Soft Grip

Packing: 6

- Exceeds ASME specification
- Straight jaws with maximum contact area
- Nickel plated to resist corrosion
- Convenient one hand release lever
- Non-slip cushion grip



PART NO.	JAW CAPACITY (inches)	LENGTH (inches)
BDMLP7SAP	1 5/16	7
BDMLP10SAP	1 3/4	10

Pliers Set, Retaining Ring, 2pcs

PR36

Packing: 1 (Set)

- Optional Tip Kit PR5 and Tips sizes .047" 0°, .070" 0°, .047" 45°, .038" 90° are sold separately



PART NO.	CONTENTS	LENGTH (inches)
PR37	Internal Ring, size range 3/8 - 2" Tip Kit PR5, Tip sizes .047" 0°, .070" 0°, .047" 45°, .038" 90°, 2 pair each	6 1/4
PR38	External Ring, size range 1/4 - 2"	6 1/4

Pliers Set, Retaining Ring, 2pcs

PR50A

Packing: 1 (Set)

- Plastic case packaging



PART NO.	CONTENTS	LENGTH (inches)
PR51	Internal Ring, size range 2 7/16 - 4" Tip Kit PR502, Tip size .108" 15° Optional: Tip Kit PR501, Tip size .108" 0°	9 1/2
PR52	External Ring, size range 1 1/2 - 3 11/32" Tip Kit PR 507, Tip size .120" 45° Optional: Tip Kit PR505, Tip size .120" 0°	9 1/2

Pliers Set, Retaining Ring, 3pcs

PRH503

Packing: 1 (Set)

- Retaining rings size are convertible
- Available in 2pcs Set, PN: PRH502A consisting of PRH56A and PRH57A
- Storage case packaging

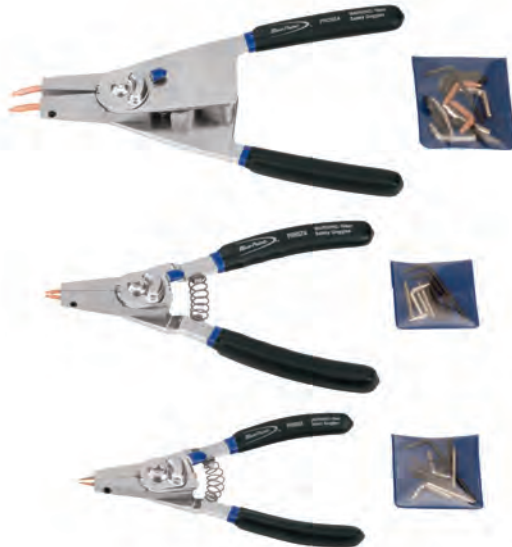

PART NO.	CONTENTS	LENGTH (inches)
PRH56A	Internal Ring, size range 1/4 - 1" External Ring, size range 1/8 - 1" Tip Kit PRH56A-1 Tip sizes .023° 0°, .036° 0°, .047° 0°, .036° 90°, .047° 90°, 1 pair each	6 3/8
PRH57A	Internal Ring, size range 3/8 - 2" External Ring, size range 1/4 - 2" Tip Kit PRH57A-1 Tip sizes .036° 0°, .047° 0°, .070° 0°, .036° 90°, .047° 90°, 1 pair each	8
PRC65A	Internal Ring, size range 1 13/64 - 4" External Ring, size range 1 1/3 - 4" Tip Kit PRC65A-1 Tip sizes .090°, .108°, .120° (15° and 90°), 1 pair each	10

Retaining Ring 15" Pliers, External

PR8A

Packing: 1

- Spring-loaded ratchet locking mechanism safely and securely holds large heavy rings
- Cushion grips for comfort and control
- Precision ground tips for maximum control and stability
- Interchangeable tips



PART NO.	CONTENTS	LENGTH (inches)
PR8A	External Ring, size range 3 1/16 - 6 1/4" Tip Kit PR8A-1, Tip size .120° 0° Optional Kits and Tip sizes: Tip Kit PR8A-2, Tip size .120° 45° Tip Kit PR8A-3, Tip size .120° 90°	15 11/16

Retaining Ring 19" Pliers, External

PR53

Packing: 1

- Interchangeable tips



PART NO.	CONTENTS	LENGTH (inches)
PR53	External Ring, size range 6 1/2 - 10" Tip Kit PR53-1, Tip size .170° 0° Optional Kits and Tip sizes: Tip Kit PR53-2, Tip size .170° 45° Tip Kit PR53-3, Tip size .170° 90°	19

Retaining Ring 29" Pliers, Internal

PR54

Packing: 1

- Interchangeable tips



PART NO.	CONTENTS	LENGTH (inches)
PR54	Internal Ring, size range 6 1/2 - 10" Tip Kit PR54-1, Tip size .150° 0° Optional Kits and Tip sizes: Tip Kit PR54-2, Tip size .150° 45° Tip Kit PR54-3, Tip size .150° 90°	29

Circlip Pliers, Straight

Packing: 6



PART NO.	DESCRIPTION	SIZE RANGE (mm)	LENGTH (inches)
BCES7	External	19 - 60	7
BCES9	External	40 - 100	9
BCIS7	Internal	19 - 60	7
BCIS9	Internal	40 - 100	9

Circlip Pliers, 90°

Packing: 6



PART NO.	DESCRIPTION	SIZE RANGE (mm)	LENGTH (inches)
BCER7	External	19 - 60	7
BCER9	External	40 - 100	9
BCIR7	Internal	19 - 60	7
BCIR9	Internal	40 - 100	9

Miniature Circlip Pliers, Straight

Packing: 6

- Dual compound soft grip handles provide good grip and comfort
- Precise machined joint for ease of use and longer life
- Drop forged chrome/nickel alloy is fine polished for corrosion resistant finish



PART NO.	DESCRIPTION	LENGTH (inches)
BCES5	External	5
BCES6	External	6



PART NO.	DESCRIPTION	LENGTH (inches)
BCIS5	Internal	5
BCIS6	Internal	6

Miniature Circlip Pliers, 45°

Packing: 6

- Dual compound soft grip handles provide good grip and comfort
- Precise machined joint for ease of use and longer life
- Drop forged chrome/nickel alloy is fine polished for corrosion resistant finish



PART NO.	DESCRIPTION	LENGTH (inches)
BCEH5	External	5
BCEH6	External	6



PART NO.	DESCRIPTION	LENGTH (inches)
BCIH5	Internal	5
BCIH6	Internal	6

Miniature Circlip Pliers, 90°

Packing: 6

- Dual compound soft grip handles provide good grip and comfort
- Precise machined joint for ease of use and longer life
- Drop forged chrome/nickel alloy is fine polished for corrosion resistant finish



PART NO.	DESCRIPTION	LENGTH (inches)
BCER5	External	5
BCER6	External	6



PART NO.	DESCRIPTION	LENGTH (inches)
BCIR5	Internal	5
BCIR6	Internal	6

Bolt Cutters, Heavy Duty

- Ideal for cutting rod, bolts, concrete form ties and fencing wire
- Hardened alloy steel jaws
- Center cut jaw configuration provides balance while cutting
- Cuts soft or hard materials
- Rubber gripped steel handles ensure firm grip during use



PART NO.	CAPACITY Soft Materials (inches)	CAPACITY Hard Materials (inches)	LENGTH (inches)	WEIGHT (kg)	
BLPBC18	3/8	1/4	18	1.55	2
BLPBC24	7/16	5/16	24	2.55	2
BLPBC30	1/2	3/8	30	3.90	1
BLPBC36	9/16	7/16	36	6.45	1

Replacement Jaws

Packing: 1



PART NO.	LENGTH (inches)
BLPBC18-1	18
BLPBC24-1	24
BLPBC30-1	30
BLPBC36-1	36

Straight Hose Clamp, 13" Pliers

HCP13

Packing: 1

- Newly designed superior ratchet mechanism for ease of operation
- Enables technician to access, release, remove and install constant tension hose clamps
- 360° rotating deep slotted tips firmly grip clamps at any angle
- Ergonomically designed with solid rivet construction for long life and durability
- Extended reach for easy access to engine compartment
- Soft touch grips are double dipped for increased comfort and control
- Heat treated steel for strength and corrosion resistance
- Electroplated arms and tips for durability



SCREWDRIVERS & BITS



Blue-Point®

Ergonomic Design = Comfort + Turning Force

Blue-Point™

M Series, Phillips®

Packing: 6

- Tri-lobe handle shape for reducing user strain while operating and offering optimum torque
- Soft cushion grip for the best performance without fatigue
- Concave hollow of the handle neck for firm pinch pressure and precision control



PART NO.	TIP SIZE (#)	A (mm)	L (mm)
BSGDM65PH00	00	65	136
BSGDM75PH0	0	75	148
BSGDM100PH0	0	100	173
BSGDM150PH0	0	150	223
BSGDM75PH1	1	75	181
BSGDM100PH1	1	100	206
BSGDM150PH1	1	150	256
BSGDM38PH2	2	38	100

PART NO.	TIP SIZE (#)	A (mm)	L (mm)
BSGDM100PH2	2	100	218
BSGDM150PH2	2	150	268
BSGDM200PH2	2	200	318
BSGDM250PH2	2	250	368
BSGDM150PH3	3	150	278
BSGDM200PH3	3	200	328
BSGDM200PH4	4	200	328

M Series, Slotted

Packing: 6

- Tri-lobe handle shape for reducing user strain while operating and offering optimum torque
- Soft cushion grip for the best performance without fatigue
- Concave hollow of the handle neck for firm pinch pressure and precision control



PART NO.	TIP SIZE (mm)	A (mm)	L (mm)
BSGDM65F2	2.4	65	136
BSGDM75F3	3.2	75	149
BSGDM100F3	3.2	100	175
BSGDM150F3	3.2	150	225
BSGDM75F5	5	75	182
BSGDM100F5	5	100	208
BSGDM150F5	5	150	258
BSGDM200F5	5	200	309

PART NO.	TIP SIZE (mm)	A (mm)	L (mm)
BSGDM38F6	6	38	100
BSGDM100F6	6	100	220
BSGDM150F6	6	150	270
BSGDM200F6	6	200	321
BSGDM250F6	6	250	372
BSGDM150F8	8	150	280
BSGDM200F8	8	200	331
BSGDM200F9	9.5	200	331



M Series, Pozidriv®

Packing: 6

- Tri-lobe handle shape for reducing user strain while operating and offering optimum torque
- Soft cushion grip for the best performance without fatigue
- Concave hollow of the handle neck for firm pinch pressure and precision control



PART NO.	TIP SIZE (#)	A (mm)	L (mm)
BSGDM65PZ00	0	65	136
BSGDM75PZ0	0	75	148
BSGDM100PZ0	0	100	173
BSGDM150PZ0	0	150	223
BSGDM75PZ1	1	75	181
BSGDM100PZ1	1	100	206
BSGDM150PZ1	1	150	256
BSGDM38PZ2	2	38	100

PART NO.	TIP SIZE (#)	A (mm)	L (mm)
BSGDM100PZ2	2	100	218
BSGDM150PZ2	2	150	268
BSGDM200PZ2	2	200	318
BSGDM250PZ2	2	250	368
BSGDM150PZ3	3	150	278
BSGDM200PZ3	3	200	328
BSGDM200PZ4	4	200	328

M Series, Torx®

Packing: 6

- Tri-lobe handle shape for reducing user strain while operating and offering optimum torque
- Soft cushion grip for the best performance without fatigue
- Concave hollow of the handle neck for firm pinch pressure and precision control



PART NO.	TIP SIZE	A (mm)	L (mm)
BSGDM75TX6	T6	75	148
BSGDM75TX7	T7	75	148
BSGDM75TX8	T8	75	148
BSGDM75TX9	T9	75	148
BSGDM100TX10	T10	100	206
BSGDM100TX15	T15	100	206

PART NO.	TIP SIZE	A (mm)	L (mm)
BSGDM100TX20	T20	100	206
BSGDM100TX25	T25	100	218
BSGDM100TX27	T27	100	218
BSGDM100TX30	T30	100	218
BSGDM100TX40	T40	100	218

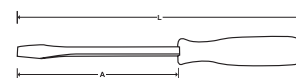

P Series, Slotted

1 Greater Adherence
Vapor-blasted tip for greater screw-tip adherence

2 Tough & Durable
The chrome molybdenum vanadium blade is hardened to HRC 59±1

3 Permanence
Size and part number are laser-etched on the blade to ensure permanence

4 Rust-Resistant
Nickel and chrome plated to prevent rust

5 Excellent Grip
Ergonomically shaped dual compound handle provides comfort and a better grip

P Series, Phillips®

P Series, Slotted

Packing: 10

- 2-Component handle gives the screwdriver an ideal ergonomic shape
- Perfectly adapted to the forces exerted by the hand and permits work efficiently
- The chrome molybdenum vanadium blade is hardened to HRC 59±1
- Nickel and chrome plated blade and the tip is especially vapor-blasted for greater screw-tip adherence and a full anti-rust guarantee
- With hanging hole moulded to the blade
- The size and part number are laser-etched on the blade to ensure their permanence



PART NO.	TIP SIZE (#)	A (mm)	L (mm)
BSGD75PH0B	PH0	75	148
BSGD100PH0B	PH0	100	187
BSGD150PH0B	PH0	150	237
BSGD100PH1B	PH1	100	208
BSGD150PH1B	PH1	150	258
BSGD200PH1B	PH1	200	308
BSGD250PH1B	PH1	250	358
BSGD300PH1B	PH1	300	408
BSGD100PH2B	PH2	100	208
BSGD150PH2B	PH2	150	258
BSGD200PH2B	PH2	200	308
BSGD250PH2B	PH2	250	358
BSGD300PH2B	PH2	300	408
BSGD150PH3B	PH3	150	270
BSGD200PH3B	PH3	200	320

PART NO.	TIP SIZE (mm)	A (mm)	L (mm)
BSGD75S3B	3	75	147
BSGD75F4B	4	100	168
BSGD100S4B	4	125	188
BSGD125S4B	4	150	233
BSGD150S4B	4	250	308
BSGD250S4B	5.5	125	358
BSGD125S5B	5.5	150	208
BSGD150S5B	6.5	250	258
BSGD125F5B	4	75	233
BSGD125F6B	5.5	125	208
BSGD150F6B	6.5	125	258
BSGD250F6B	6.5	150	358
BSGD150F8B	8	150	270
BSGD175F8B	8	175	320

131



WARNING



- Do not use screwdrivers as prybars, chisels or punches
- Read safety precautions on page 220

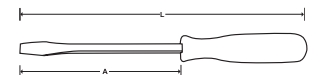

Precision Screwdriver, Phillips®

Packing: 6

- Spinning handle for ease of use
- Oil resistant, bi-material handle
- Soft cushion grip for the best performance



PART NO.	TIP SIZE (#)	A (mm)	L (mm)
BSGPDM50PH0	PH0	50	145
BSGPDM50PH00	PH00	50	145
BSGPDM50PH000	PH000	50	145
BSGPDM50PH1	PH1	50	145
BSGPDM50PH2	PH2	50	145

Precision Screwdriver, Slotted

Packing: 6

- Spinning handle for ease of use
- Oil resistant, bi-material handle
- Soft cushion grip for the best performance



PART NO.	TIP SIZE (mm)	A (mm)	L (mm)
BSGPDM50F1	1.4	50	145
BSGPDM50F2	2	50	145
BSGPDM50F24	2.4	50	145
BSGPDM50F3	3	50	145

Pass-Through Screwdriver, Phillips®

Packing: 6

- High tensile Chrome Vanadium Steel
- Oil resistant, bi-material handle
- Ergonomically designed handle for excellent grip and user comfort



PART NO.	TIP SIZE (#)	A (mm)	L (mm)
BSGDPT100PH2	PH2	100	207
BSGDPT150PH2	PH2	150	257
BSGDPT150PH3	PH3	150	265
BSGDPT200PH3	PH3	200	315
BSGDPT250PH3	PH3	250	365

Pass-Through Screwdriver, Slotted

Packing: 6

- High tensile Chrome Vanadium Steel
- Oil resistant, bi-material handle
- Ergonomically designed handle for excellent grip and user comfort



PART NO.	TIP SIZE (mm)	A (mm)	L (mm)
BSGDPT100F6	6	100	207
BSGDPT150F6	6	150	257
BSGDPT150F8	8	150	265
BSGDPT200F8	8	200	315
BSGDPT250F8	8	250	365

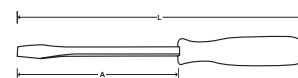

1/4" Ratchet Screwdriver, Pistol Handle



1/4" Ratchet Screwdriver, Pistol Handle

BSGD MR6

Packing: 1

- 5" magnetic bit holder blade for 1/4" hex bits
- 45 tooth ratcheting mechanism ensures precise positioning and movement
- Bits are stored in a bit magazine inside the handle
- Includes six 1/4" hex bits: Flat Tip (4.5 and 5.5), Phillips® (#1 and #2) plus Torx® (T15 and T20)
- Ergonomically designed two component handle is textured for excellent grip and user comfort
- Provides three functional options, left and right turning and locked position
- Blade features a knurled-grip for fast spinning of the fastener
- Screwdriver carries a lifetime warranty (Bits are consumable and carry no warranty)



133



WARNING



- Do not use screwdrivers as prybars, chisels or punches
- Read safety precautions on page 220



Power Bit Set, 52pcs

YA52PBSQC

Packing: 1

- Ideal for use with cordless drills and screwdrivers
- Set includes:
 - 2 hex adaptors
 - Flat tip bits (long): 6-8, 8-10, 10-12
 - Hex bits (short): 1/8", 9/64", 5/32", 3/16", 7/32", 1/4", 9/32"
 - Hex bits (long): 5/32", 3/16", 7/32"
 - PHILLIPS® tip bits (short): #1, #2 (2 each), #3
 - PHILLIPS® tip bits (long): #1, #2, #3
 - TORX® tamper resistant bits (short and long):
 - T10, T15, T20, T25, T27, T30, T40
 - Square bits (short and long): #1, #2, #3
 - Clutch bits (short and long): 5/32", 3/16"
 - Double end bits: 6-8 x #2 PHILLIPS®, 8-10 x #3 PHILLIPS®
 - Adaptors: 1/4" hex female to 1/4" hex female, 1/4" hex male to 1/4" square male, 1/4" hex quick change chuck
- Storage case packaging



Master Ball Hex Bit Set, 32pcs

SDM32KT

Packing: 1

- 1/4" shank bits for use in difficult access applications where fastener cannot be approached straight-on
- Set includes:
 - Fractional Ball Hex Bits: 3/32", 7/64", 1/8", 9/64", 5/32", 3/16", 7/32", 1/4", 5/16", 3/8"
 - Metric Ball Hex Bits: 2, 2.5, 3, 4, 5, 6, 7, 8, 9, 10mm
 - TORX® Ball Hex Bits: T10, T15, T20, T25, T27, T30, T40, T45, T50, T55
 - Magnetic Insert Bit Holder
 - 1/4" Female Hex to 1/4" Female Sq. Dr. Adaptor
- All components store in case with belt clip



Torx Ball Hex Bit Set, 11pcs

SDM11KT

Packing: 1

- 1/4" shank bits for use in difficult access applications where fastener cannot be approached straight-on
- Set includes:
 - TORX® Ball Hex Bits: T10, T15, T20, T25, T27, T30, T40, T45, T50
 - Magnetic Insert Bit Holder
 - 1/4" Female Hex to 1/4" Female Sq. Dr. Adaptor
- All components store in case with belt clip



Hex Bits

Packing: 6

PART NO.	SIZE (inches)
BLPHB18	1/8
BLPHB964	9/64
BLPHB532	5/32
BLPHB316	3/16
BLPHB732	7/32
BLPHB14	1/4

PART NO.	SIZE (mm)
BLPHBM3	3
BLPHBM4	4
BLPHBM5	5
BLPHBM6	6



Tamper Resistant Torx® Bits

Packing: 6

PART NO.	SIZE
BLPTB10TP	T10
BLPTB15TP	T15
BLPTB20TP	T20
BLPTB25TP	T25
BLPTB30TP	T30



Flat Tip Bits

Packing: 6

PART NO.	SIZE (inches)
BLPFB532	5/32
BLPFB316	3/16
BLPFB732	7/32
BLPFB14	1/4
BLPFB932	9/32



Phillips® Tip Bits

Packing: 6

PART NO.	SIZE (#)
BLPPB0	0
BLPPB1	1
BLPPB2	2
BLPPB3	3



Square Tip Bits

Packing: 6

PART NO.	SIZE (#)
BLPSQB1	1
BLPSQB2	2





Bits Set, 31pcs

BITSET31AP

Packing: 1

- S2 material
- Magnetic bit holder and 30 bits
- 1/4" hex bits
- Plastic box with clip packaging in display box
- Philips: #1, #2*2, #3
- Pz : #1, #2*2, #3,
- TORX®: T10,T15,T20,T25,T27,T30,T40
- TORX®: T10,T15,T20,T25,T27,T30,T40 Tampered
- Slotted: 3, 4, 5, 6 mm
- Hex: H3, H4, H5, H6



Bits Set, 72pcs

BLP72BITS

Packing: 1

- Set consists of different sizes of TORX®, Slotted, Philips, Pozidriv, Square and Hex bits, and also includes a 60mm magnetic bit holder allowing for quick change of driving bits
- Folding case design is compact and robust with pivoting dual bit holders that allow for easy and quick access to the accessories.
- S-2 grade
- All parts are engineered and produced according to ANSI Standard



STRIKING & CUTTING TOOLS

Strength, Durability & Safety



Blue-Point[®]



Ball Peen - Wood Handle



1 High carbon steel forged head

2 Wooden handle with reinforced metal for toughness

3 Faces are ground and polished to prevent cuts and burrs



Ball Peen, Wood Handle

Packing: 1



PART NO.	WEIGHT (oz.)
BPB4	4
BPB8	8
BPB12	12
BPB16	16
BPB24	24
BPB32	32
BPB40	40
BPB48	48

Ball Peen, Fiberglass Handle

Packing: 1



PART NO.	WEIGHT (oz.)	HANDLE LENGTH (inches)	REPLACEMENT HANDLE
BPN8B	8	11	BPNH8B
BPN12B	12	12	BPNH12B
BPN16B	16	13	BPNH12B
BPN24B	24	14	BPNH24B
BPN32B	32	16	BPNH24B

Ball Peen, Fiberglass Handle

Packing: 1

- Head material is medium carbon steel with black baked paint finish, normal polished on striking face
- Non-slip Blue 60% PP jacketed fiberglass with comfort grip
- Used for mainly metalwork, and for use with punch and chisels
- Striking and shaping metal materials



PART NO.	WEIGHT (oz.)	HANDLE LENGTH (mm)
BLPBFG8	8	278
BLPBFG12	12	283
BLPBFG16	16	327
BLPBFG24	24	383
BLPBFG32	32	385

Soft Face

Packing: 1

- Combination steel and soft face dead blow
- One-piece urethane construction



PART NO.	WEIGHT (g)	HEAD LENGTH (mm)	HEAD WIDTH (mm)	LENGTH (mm)
BHW35	380	100	35	300
BHW45	500	110	45	320

Soft Face

1 Combination steel and soft face dead blow



2 One-piece urethane construction



4 The 13" long fiberglass handle has a plastic shock-absorbing grip



3 Combination steel and soft face dead blow



Soft Face

BH232A

Packing: 1

- Combination steel and soft face dead blow
- One-piece urethane construction
- 13" long fiberglass handle has a plastic, shock-absorbing grip
- Tip diameter is 1 5/8"
- Includes 2 replaceable tips:
 - BH232-2, Soft tip
 - BH232-3, Hard tip
- Optional:
 - BH232-4, Nylon tip



PART NO.	WEIGHT (oz.)	LENGTH (inches)
BH232A	32	13

Soft Blow

BF623

Packing: 1

- Use on all types of surfaces and assemblies including metal, glass, plastic and wood
- Conforms to irregular surfaces
- Designed for maximum surface contact
- Low rebound
- Dissipates hand jarring shock
- Resists most chemicals
- Wood handle
- Reduces denting and marring



PART NO.	LENGTH (inches)	FACE DIMENSIONS (inches)	HEAD COLOR
BF623	12 1/2	1 7/8 x 2 1/8	Blue

Cross Peen, Hickory Handle

Packing: 1

- Forged high-quality steel that has been hardened and tempered
- Concentrated weight distribution behind the striking face for added power
- Durable, flat black finish on the head
- Polished face, hickory handle
- Wood wedged for easy handle replacement



PART NO.	WEIGHT (oz.)	HEAD LENGTH (mm)	OVERALL LENGTH (mm)
BLPCPH2	2	120	354
BLPCPH25	2.5	122	357
BLPCPH3	3	128	360
BLPCPH4	4	148	400

Cross Peen, Hickory Handle

Packing: 1



PART NO.	WEIGHT (oz.)	HEAD LENGTH (inches)	OVERALL LENGTH (inches)	REPLACEMENT HANDLE
BH141A	32	4 1/2	15	BPH20C
BH142A	40	5	15	BPH40C

Dead Blow

Packing: 1

- Non-conductive face with no exposed metal
- Oil and chemical resistant
- Steel shot used for dead-blow action
- Steel-reinforced handle adds strength and safety
- Perfect for shaping and cutting fine amount of materials
- Come in 2 head sizes 55 and 65 mm



PART NO.	HEAD SIZE (mm)	LENGTH (mm)
BLPDBH55	55	350
BLPDBH65	65	370

Dead Blow, Interchangeable Tip

Packing: 1

- Steel head with nylon tip
- Tubular handle with black soft grip
- Steel shot used for dead blow action
- Steel-reinforced handle adds strength and safety
- Oil and chemical resistant
- Soft face help prevent marring of surfaces and equipment
- Come in 2 interchangeable head sizes 30 and 40 mm



PART NO.	HEAD SIZE (mm)	LENGTH (mm)
BLPDBH301	30	298
BLPDBH401	40	300

Rubber Head Mallet

Packing: 1

- Use wherever you want to protect what you are striking from damage
- Mallet head is constructed of synthetic material
- Bounce resistant head for better control and precise hits
- Genuine hickory handle



PART NO.	WEIGHT (ozs)	LENGTH (mm)	FACE DIMENSIONS (mm)
BLPRM12	12	266	59
BLPRM16	16	310	62
BLPRM24	24	310	70

Rubber Head Mallet

BF620C

Packing: 1

- Solid rubber head
- 11" Hardwood handle
- Ideal for replacing hubcaps, bodywork, etc



PART NO.	LENGTH (inches)	FACE DIMENSIONS (inches)
BF620C	13 1/4	3 3/4 x 2 1/4

Curve Claw, Hickory Handle

Packing: 1

- Head material: Medium carbon steel
- Head finish: Sand-blasted finish, fully polish
- Handle: Hickory handle in natural color
- Used for general woodworking, curved claw provided better leverage for removing nails
- Great to use in heavy or professional carpentry for ripping and framing work



PART NO.	WEIGHT (ozs)	LENGTH (mm)	STRIKING FACE DIMENSIONS (mm)
BLPCCH7	7	292	22.5
BLPCCH10	10	295	24.5
BLPCCH13	13	318	27
BLPCCH16	16	329	28
BLPCCH20	20	330	30
BLPCCH24	24	356	33

Rubber Head Mallet

BPRH15

Packing: 1

- Solid rubber head
- 11" hickory handle
- Ideal for replacing hubcaps, bodywork, etc



PART NO.	LENGTH (inches)	FACE DIMENSIONS (inches)
BPRH15	11	3 3/4 x 2 1/4

Curve Claw, Fiberglass Handle

Packing: 1

- Head material: Medium carbon steel
- Head finish: Sand-blasted finish, fully polish
- Handle: Non-slip Blue 60% PP jacketed fiberglass with comfort grip
- Used for general woodworking, curved claw provided better leverage for removing nails
- Great to use in heavy or professional carpentry for ripping and framing work



PART NO.	WEIGHT (ozs)	LENGTH (mm)	STRIKING FACE DIMENSIONS (mm)
BLPCCFG7	7	280	22.5
BLPCCFG10	10	292	24.5
BLPCCFG16	16	327	28
BLPCCFG20	20	329	30
BLPCCFG24	24	385	33

Curve Claw Hammer

BLPCL8

Packing: 6

- 8oz steel tube



PART NO.	WEIGHT (oz.)	STRIKING FACE DIAMETER (mm)	LENGTH (mm)
BLPCL8	360	23	260

Brass Hammer

Packing: 1

- Non-sparking/non-marring surface for many applications
- Brass head absorbs blow and reduces rebound
- Flat surface for even distribution of blow
- Fiberglass handle for strength
- Comfortable, non-slip handle grip



PART NO.	WEIGHT (lbs.)	LENGTH (inches)
HBR15	1 1/2	12
HBR25	2 1/2	12

Wheel with Hammer SML Hook

WWH13SM

Packing: 1

- Heavy-duty, Nuplaglas® handle is chemical-resistant and features non-slip cushioned grip
- 30oz head weight for working on larger vehicles
- Removes “perfect-style” wheel weights without touching rim of vehicle and larger v-clips found on medium duty truck rims



Fiberglass Hammer

Packing: 1

- Fiberglass handle dampens vibration and provides extra strength and safety
- Handle is epoxy-welded to hammer head and will withstand 8,000 lbs. of separation force
- Handle is resistant to dry rot, warp and splintering
- Comfortable, non-slip handle grip
- Materials will resist most shop chemicals



PART NO.	DESCRIPTION	WEIGHT (lbs)	STRIKING FACE DIAMETER (inches)	HANDLE LENGTH (inches)	OVERALL LENGTH (inches)	REPLACEMENT HANDLE
BC4SG	Cross Peen	4	1 1/2	12	14	BD4SG-1
BD4SG	Engineer	4	1 1/2	12	14	BD4SG-1
HD4SG	Hand Drilling	4	1 1/2	8 3/4	10 3/4	HD4SG-1



Pin Punch Set, 6pcs

BLPRP6

Packing: 1

- High quality Cr-V
- Mix punch set



PART NO.	CONTENTS
BLPRP6	8 x 180mm L L Pin Punch
	6 x 180mm L Pin Punch
	5 x 165mm L Pin Punch
	4 x 150mm L Pin Punch
	3 x 125mm L Pin Punch
	2 x 115mm L Pin Punch

Punch Set

DPFT528B

Packing: 1

- For transferring hole patterns
- Set includes punches from 3/32" to 1/2" in 1/64" increments plus 17/32"
- Each punch is marked with its size and manufactured from tempered steel to promote long tool life
- A metal index provides convenient storage
- Punches are 4 7/8" in length



Punch & Chisel Set, 5pcs

BLPPC5

Packing: 1

- Chrome-plated for corrosion resistance
- Comes with a plastic holder



PART NO.	CONTENTS
BLPPC5	#2 Central Punch
	3mm Hole Punch
	4mm Pin Type Punch
	5mm Boring Bit
	12mm Flat Chisel

Automatic Center Punch

YA900

Packing: 1

- Strikes blow when pressure is applied - no hammer needed
- Cap adjusts force of blow
- 7/16" diameter
- 4 3/4" long



Automatic Center Punch

YA879A

Packing: 1

- Single handed operation
- Design eliminates need for striking with hammer
- Adjustable spring tension cap
- Hardened steel point is replaceable
- 1/2" diameter
- 5" long



Transfer Punch Set, 31pcs

DPFT531

Packing: 1

- Set includes 31 punches from 3/32" - 1" in roll bag provides convenient storage
- For transferring hole patterns
- Size marking on each punch and manufactured from tempered steel to promote long tool life
- Punches are 4 7/8" in length



Transfer Punch

Packing: 1

- For transferring hole patterns
- Size marking on each punch and manufactured from tempered steel to promote long tool life
- Punches are 4 7/8" in length



PART NO.	CONTENTS
DPFT531-6	3/32" Transfer Punch
DPFT531-7	7/64" Transfer Punch
DPFT531-8	1/8" Transfer Punch
DPFT531-9	9/64" Transfer Punch
DPFT531-10	5/32" Transfer Punch
DPFT531-11	11/64" Transfer Punch
DPFT531-12	3/16" Transfer Punch
DPFT531-13	13/64" Transfer Punch
DPFT531-14	7/32" Transfer Punch
DPFT531-15	15/64" Transfer Punch
DPFT531-16	1/4" Transfer Punch
DPFT531-17	17/64" Transfer Punch
DPFT531-18	9/32" Transfer Punch
DPFT531-19	19/64" Transfer Punch
DPFT531-20	5/16" Transfer Punch
DPFT531-21	21/64" Transfer Punch

PART NO.	CONTENTS
DPFT531-22	11/32" Transfer Punch
DPFT531-23	23/64" Transfer Punch
DPFT531-24	3/8" Transfer Punch
DPFT531-25	25/64" Transfer Punch
DPFT531-26	13/32" Transfer Punch
DPFT531-27	27/64" Transfer Punch
DPFT531-28	7/16" Transfer Punch
DPFT531-29	29/64" Transfer Punch
DPFT531-30	15/32" Transfer Punch
DPFT531-31	31/64" Transfer Punch
DPFT531-32	1/2" Transfer Punch
DPFT531-34	17/32" Transfer Punch
DPFT531-48	3/4" Transfer Punch
DPFT531-56	7/8" Transfer Punch
DPFT531-64	1" Transfer Punch

Scraper Set, 3pcs

PKB500A

Packing: 1

- Spring tempered, solid brass blades are non-marring, non-sparking, non-magnetic and non-corrosive
- Soft molded rubber handles maximize hand grip, easy to clean and resistant to most solvents
- Broad hilt design helps protect against hand slipping when scraping
- Stiff blade style



PART NO.	HANDLE LENGTH (inches)	BLADE LENGTH (inches)	BLADE WIDTH (inches)	BLADE STYLE	EDGE
PKB50A	4 7/8	3 1/2	2	Stiff	Straight
PKB52A	4 7/8	3 19/32	1 1/4	Stiff	Straight
PKB53A	4 7/8	3 19/32	1 1/4	Stiff	Single Bevel

Scraper Set, 3pcs

USS103

Packing: 1

- Remove gaskets, sealers and other caked on materials
- Blade edge designed to work effectively in both push and pull directions
- Stainless steel blades for durability
- Polished blades clean up easily
- Comfortable composite handles feature a contour thumb stop for maximum control and a wide hilt for control



PART NO.	BLADE STYLE	BLADE LENGTH (inches)	LENGTH (inches)
US710	Spoon	3 1/2	8
US711	Chisel Tip	2 1/2	7 1/8
US712	Oyster	2 1/8	6 3/4

STRIKING & CUTTING Punches / Scrapers

Scraper Set, 3pcs

PK500A

Packing: 1

- Features full length steel blades for strength and durability
- Soft molded rubber handles maximize hand grip, easy to clean and resistant to most solvents
- Broad hilt design helps protect against hand slipping when scraping



PART NO.	BLADE LENGTH (inches)	BLADE WIDTH (inches)	BLADE STYLE	EDGE
PK50A	3 1/2	2	Flexible	Straight
PK52A	5 19/32	1 1/4	Flexible	Straight
PK53A	2 19/32	1 1/4	Stiff Chisel	Single Bevel

Scraper, Walnut Handle

Packing: 1

- Quality crafted for hard scraping applications
- Walnut wood handle for comfort
- Full length heavy duty blades for strength
- Large steel cap for striking capability
- Remove gaskets, sealants and body weld breakaway



PART NO.	BLADE LENGTH (inches)	BLADE WIDTH (inches)	BLADE STYLE	EDGE	LENGTH (inches)
PKWLR53A	5 1/2	1 1/4	Straight	Chisel	9 1/2
PKWSS53A	2 3/4	1 1/4	Straight	Chisel	6 3/4

Scraper, Wood Handle

PK23A

Packing: 1

- Mirror finished hardened steel blade extends through hardwood handle, solidly riveted for durability
- Redwood handle has metal bolster where handle meets blade



PART NO.	HANDLE MATERIAL	HANDLE LENGTH (inches)	BLADE WIDTH (inches)	BLADE STYLE	EDGE
PK23A	Maple	3 7/8	1 1/4	Heavy Chisel	Single Bevel

File Sets

Packing: 1

- Set in pouch for easy storage, portability or to hang in workshop
- All sets are in 2nd-Cut
- Tough, durable HSS bi-material handle



PART NO.	DESCRIPTION	SIZES (inches)
BLFF1S4	Coarse Flat File, 4pcs	6, 8, 10, 12
BLFF2S4	Flat 2nd Cut File Set, 4pcs	6, 8, 10, 12
BLFRS4	Round File Set, 4pcs	6, 8, 10, 12
BLFHRS4	Half Round File Set, 4pcs	6, 8, 10, 12
BLFT4	Triangle File Set, 4pcs	6, 8, 10, 12

Flat 2nd-Cut File

Packing: 3

- Tough, durable HSS bi-material handle
- Perfect for shaping and cutting fine amount of materials



PART NO.	LENGTH (inches)
BLFFS6	6
BLFFS8	8
BLFFS10	10
BLFFS12	12

Round 2nd-Cut File

Packing: 3

- Tough, durable HSS bi-material handle
- Perfect for shaping and cutting fine amount of materials



PART NO.	LENGTH (inches)
BLFRS6	6
BLFRS8	8
BLFRS10	10
BLFRS12	12

Coarse Flat File

Packing: 3

- Tough, durable HSS bi-material handle
- Perfect for shaping and cutting fine amount of materials



PART NO.	LENGTH (inches)
BLFFC6	6
BLFFC8	8
BLFFC10	10
BLFFC12	12

Half Round 2nd-Cut File

Packing: 3

- Tough, durable HSS bi-material handle
- Perfect for shaping and cutting fine amount of materials



PART NO.	LENGTH (inches)
BLFHS6	6
BLFHS8	8
BLFHS10	10
BLFHS12	12

Triangular 2nd-Cut File

Packing: 3

- Tough, durable HSS bi-material handle
- Perfect for shaping and cutting fine amount of materials



PART NO.	LENGTH (inches)
BLFTS6	6
BLFTS8	8
BLFTS10	10
BLFTS12	12



Shears, Angled, Heavy Duty

SNP2A

Packing: 1

- For leather, cloth, plastic, rubber sheet, rubber hose, cardboard, gasket material, rope and many other materials
- Stainless steel blades and fasteners ensure durability
- Precision ground and heat treated for a long lasting edge
- Ergonomic handles can be used right or left handed
- Top of blade is notched for hard wire and twine
- Locking switch ensures safety during storage
- Control switch allows blades to be held in a tighter position for easier handling
- Angled shears allow easier cutting through flat materials
- Soft mold grip for comfort and control



Sheet Metal Snips, Straight

Packing: 1

- Special laborsaving, designed for easier cutting
- High tensional strength spring designed for longer life
- Solid, comfortable handle with non-design provide grip comfort
- Serrated edges prevent slipping
- Cr-Mo alloy steel hot forged blades for greater strength and longer durability



Sheet Metal Snips, Offset

Packing: 1

- Special laborsaving, designed for easier cutting
- High tensional strength spring designed for longer life
- Solid, comfortable handle with non-design provide grip comfort
- Serrated edges prevent slipping
- Cr-Mo alloy steel hot forged blades for greater strength and longer durability



PART NO.	DESCRIPTION	BLADES LENGTH (mm)	OVERALL LENGTH (mm)
AVSNP01030CN	Straight Yellow handle	38	254
AVSNP01010CN	Straight, Left cutting Red handle	35	248
AVSNP01020CN	Straight, Right cutting Green handle	35	248

PART NO.	DESCRIPTION	BLADES LENGTH (mm)	OVERALL LENGTH (mm)
AVSNPOS1010	Offset, Left cutting Orange handle	30	245
AVSNPOS1020	Offset, Right cutting Blue handle	30	245

Tin Snips

Packing: 1

- Drop forged of steel in one piece construction
- Black cushion handle with smooth, comfortable bows for ease in use and safety
- Designed for cutting straight and wide curves to the left or right
- Induction hardened cutting edges 58-61 HRC



PART NO.	BLADES LENGTH (mm)	OVERALL LENGTH (mm)
BLPSPSNIP8	40	206
BLPSPSNIP10	51	263
BLPSPSNIP12	70	310
BLPSPSNIP16	63	415

Tin Snips

Packing: 1

- Cut straight, circular, or irregular patterns; right or left cuts



PART NO.	DESCRIPTION	BLADES LENGTH (inches)	LENGTH (inches)
CD7A	Duckbill Snips	1 1/2	7
CD10A	Duckbill Snips	2 1/4	10
CD12A	Combination Snips	3	12
CD16A	Bulldog Snips	2 1/2	16

Scissors, Shop, Heavy Duty

HDSCISSORS

Packing: 1

- For leather, cloth, plastic, rubber sheet, rubber hose, cardboard, gasket material, rope and many other materials
- Stainless steel blade and fasteners
- Precision ground and heat treated for a long lasting edge
- Ergonomic handles can be used right or left handed



Vinyl Cutter

YA444B

Packing: 1

- Cleanly cuts plastic, rubber, vinyl, upholstery, leather, hoses, and rope
- Ergo Grip handle with safety lock
- Blade storage in handle
- Includes YA444B1 replacement blades



PART NO.	DESCRIPTION
YA444B	Vinyl Cutter with YA444B1 replacement blades
YA444B1	3 Replacement blades and anvil



Utility Knife

LBUK1

Packing: 1

- Utility knife with 10 replacement blades in leather pouch, both with Blue-Point® logo
- Convenience and good looks of a folding lock back knife with easily replaceable two notch razor blades
- Folding lock back blade, hardwood handle with belt clip and thumb stud for one-hand opening
- Uses UKBU10 (10 pack) or UKBU50PK (50 pack) replacement blades



Utility Knife Blades

Packing: 1

UKBU10

- High performance blades are perfect for thick, dense materials
- Bi-metal construction allows blade to bend/flex without breaking under normal work conditions
- Bi-metal lasts up to 3 times longer than normal utility knife blades
- Two-notch blade design fits most standard utility knives
- Pack of 10 blades



UKBU10

UKBU50PK

- High performance blades are perfect for thick, dense materials
- Bi-metal construction allows blade to bend/flex without breaking under normal work conditions
- Bi-metal lasts up to 3 times longer than normal utility knife blades
- Two-notch blade design fits most standard utility knives
- Convenient dispenser provides storage for used blades
- Dispenser of 50 blades



UKBU50PK

Mini Hacksaw

BLPMHF6

Packing: 1

- 25mm in length
- 24TPI blade



NEW! Junior Hacksaw, 6"

BLPHSAW6

Packing: 1

- Aluminum alloy frame for lightweight
- Handle with rubber grip for comfort handling and control
- Tri-direction adjustable
- Length: 6"
- TPI: 24



Cutters, Multi-Purpose

Packing: 1

YA580A

- Features auto locking, fully retractable blade
- All metal body is black with pocket clip
- Includes (1) premium steel 13-point, snap blade
- Overall length of 5 3/8" (136.5mm)



YA580A

YA580A-1
Replacement Blades

- Pack of 5

YA581A

- 3 blades with 8 snap off points.
- Minimum blade wobble
- Fully retractable



YA581A

YA581A-1
Replacement Blades

- Pack of 10

POWER TOOLS

Power & Speed For Professionals



Blue-Point®



3/8" IMPACT WRENCH



1/4" Impact Wrench, Mini

AT235MCA

Packing: 1

- Composite housing contributes to an extremely durable, lightweight unit with new molded comfort grip
- Composite housing is not cold to the touch
- Forward/Reverse mechanism easily operated with one-finger
- Large, variable speed trigger for control
- Exhaust is from the handle bottom, keeping exhaust away from work area and user



PART NO.	DRIVE SIZE (inches)	MAX. TORQUE (N•m)	FREE SPEED (rpm)
AT235MCA	1/4	34	13,000
BLOWS PER MINUTE	AIR CONSUMPTION, FREE SPEED (l/min)	AIR INLET THREAD SIZE	RECOMMENDED HOSE SIZE (inches)
2,900	47	1/4" - 18 NPT	3/8
VIBRATION LEVEL (m/s ²)	SOUND LEVEL dBa PRESSURE	LENGTH (mm)	WEIGHT (kg)
<2.5	95.1	158	0.64

3/8" Impact Wrench, Composite

AT370

Packing: 1

- Shot Peen Anvils for improved durability
- Reverse Bias motor provides additional breakaway torque
- 3 position regulator to control power
- One handed forward/reverse lever for user convenience
- Composite housing with aluminum nose combine to deliver a durable, lightweight and balanced unit.
- Twin hammer impact mechanism delivers hard hitting blows to quickly remove stubborn fasteners



PART NO.	DRIVE SIZE (inches)	MAX. TORQUE (N•m)	FREE SPEED (rpm)	BLOWS PER MINUTE
AT370	3/8	434	10,000(F), 11,000(R)	1,050
AIR CONSUMPTION, FREE SPEED (l/min)	AIR INLET THREAD SIZE	RECOMMENDED HOSE SIZE (inches)	VIBRATION LEVEL (m/s ²)	
4.4 cfm(F), 4.7 cfm (R)	1/4" - 18 NPT	3/8	3.25	
SOUND LEVEL dBa PRESSURE	LENGTH (mm)	WEIGHT (kg)	VINYL BOOT (optional)	
92	160	1.19	AT370BOOT	

3/8" Impact Wrench

AT380A

Packing: 1

- 10% more power than the AT380
- Built-in five position adjustable air regulator plus a variable speed trigger for maximum user control
- Aluminum housing provides a lightweight yet durable tool
- Tapered nose increases accessibility to confined areas
- Ball-bearing mounted motor creates a smooth running operation for less user fatigue
- Brass inlet filter screens out dirt and grit; easy-to-remove filter for cleaning
- Twin-hammer impact mechanism designed to hit hard yet offer tool longevity. One-year limited warranty



PART NO.	DRIVE SIZE (inches)	MAX. TORQUE (N•m)	FREE SPEED (rpm)	BLOWS PER MINUTE
AT380A	3/8	230	8,700	1,680
AIR CONSUMPTION, FREE SPEED (l/min)	AIR INLET THREAD SIZE	RECOMMENDED HOSE SIZE (inches)	VIBRATION LEVEL (m/s ²)	
111	1/4" - 18 NPT	3/8	3.5	
SOUND LEVEL dBa PRESSURE	LENGTH (mm)	WEIGHT (kg)	VINYL BOOT (optional)	
94	165	1.36	AT380ABOOT	

3/8" Impact Wrench, Composite

AT3600C

Packing: 1

- Composite housing with Magnesium Nose
- Lightweight at 1.7kg
- Maximum torque of 510Nm / 375 ft. lb. of Torque
- Twin Hammer Mechanism
- Ergonomic cushion grip reduces vibration



PART NO.	DRIVE SIZE (inches)	TORQUE RANGE (N•m)	FREE SPEED (rpm)	BLOWS PER MINUTE
AT3600C	3/8	108 - 375	6,500	1,300
AIR CONSUMPTION, FREE SPEED (l/min)	AIR INLET THREAD SIZE	RECOMMENDED HOSE SIZE (inches)	VIBRATION LEVEL (m/s ²)	
7.06 cfm	1/4" - 18 NPT	3/8	4	
SOUND LEVEL dBa PRESSURE	LENGTH (mm)	WEIGHT (kg)	VINYL BOOT (optional)	
94	149	1.47	AT3600CBOOT	

Impact Wrench



3/8" Impact Wrench, Single Hammer

AT321

Packing: 1

- Single hammer impact mechanism
- Steel nose case with lightweight aluminum housing
- Convenient slide bar forward/reverse



PART NO.	DRIVE SIZE (inches)	MAX. TORQUE (N•m)	FREE SPEED (rpm)	BLOWS PER MINUTE
AT321	3/8	237	11,000	1,500
AIR CONSUMPTION, FREE SPEED (l/min)	AIR INLET THREAD SIZE	RECOMMENDED HOSE SIZE (inches)	VIBRATION LEVEL (m/s ²)	
108	1/4" - 18 NPT	3/8	9.8	
SOUND LEVEL dBa PRESSURE	LENGTH (mm)	WEIGHT (kg)	VINYL BOOT (optional)	
109	155	1.3	AT321-44	

3/8" Impact Wrench, Compact

AT351

Packing: 1

- Built-in air inlet swivel
- 8 position power regulator
- Rotary action air motor is ball bearing mounted for balance, speed and power
- Ideal tool for small engine repair and bench work



PART NO.	DRIVE SIZE (inches)	MAX. TORQUE (N•m)	FREE SPEED (rpm)
AT351	3/8	237	9,700
BLOWS PER MINUTE	AIR CONSUMPTION, FREE SPEED (l/min)	AIR INLET THREAD SIZE	RECOMMENDED HOSE SIZE (inches)
1,200	71	1/4" - 18 NPT	3/8
VIBRATION LEVEL (m/s ²)	SOUND LEVEL dBa PRESSURE	LENGTH (mm)	WEIGHT (kg)
3.09	109.2	194	1.2

1/2" Impact Wrench

AT5500

Packing: 1

- Built-in five position adjustable air regulator plus a variable speed trigger for maximum user control
- Twin-hammer impact mechanism designed to hit hard yet offer tool longevity
- Inlet filter screens out dirt and grit; easy-to-remove filter for cleaning



PART NO.	DRIVE SIZE (inches)	MAX. TORQUE (N•m)	FREE SPEED (rpm)
AT5500	1/2	745	7,400
BLOWS PER MINUTE	AIR CONSUMPTION, FREE SPEED (l/min)	RECOMMENDED HOSE SIZE (inches)	VIBRATION LEVEL (m/s ²)
1,200	118.9	3/8	4
SOUND LEVEL dBa PRESSURE	LENGTH (mm)	WEIGHT (kg)	VINYL BOOT (optional)
94	200	2.9	AT5500BOOT

1/2" Impact Wrench, Stubby

AT5500T

Packing: 1

- 550 ft-lb of torque, 9000 RPM and 1200 blows per minute
- Compact and lightweight for reduced user fatigue
- Twin-hammer impact mechanism hits harder and delivers increased tool longevity
- Polished aluminum housing is durable and easy to clean
- Ball-bearing mounted motor for smooth running operation
- Removable brass inlet filter protects tool from grit and debris
- Large forward/reverse lever for one-handed operation



PART NO.	DRIVE SIZE (inches)	MAX. TORQUE (N•m)	FREE SPEED (rpm)
AT5500T	1/2	745	9,000
BLOWS PER MINUTE	RECOMMENDED HOSE SIZE (inches)	VIBRATION LEVEL (m/s ²)	SOUND LEVEL dBa PRESSURE
1,200	3/8	4	94
LENGTH (mm)	WEIGHT (kg)	VINYL BOOT (optional)	
183	2.29	AT5500TBOOT	

1/2" Impact Wrench, Stubby Ext. Anvil

AT5500TL

Packing: 1

- 550 ft-lb of torque, 9000 RPM and 1200 blows per minute
- Compact and lightweight for reduced user fatigue
- Twin-hammer impact mechanism hits harder and delivers increased tool longevity
- Polished aluminum housing is durable and easy to clean
- Ball-bearing mounted motor for smooth running operation
- Removable brass inlet filter protects tool from grit and debris
- Large forward/reverse lever for one-handed operation
- Deep recessed application
- 2" anvil



PART NO.	DRIVE SIZE (inches)	MAX. TORQUE (N•m)	
AT5500TL	1/2	745	
FREE SPEED (rpm)	BLOWS PER MINUTE	RECOMMENDED HOSE SIZE (inches)	
9,000	1,200	3/8	
VIBRATION LEVEL (m/s ²)	SOUND LEVEL dBa PRESSURE	LENGTH (mm)	WEIGHT (kg)
4	94	205	2.33

1/2" Impact Wrench, Composite

AT570

Packing: 1

- Shot Peen Anvils for improved durability
- Reverse Bias motor provides additional breakaway torque
- 3 position regulator to control power
- One handed forward/reverse lever for user convenience
- Composite housing with aluminum nose combine to deliver a durable, lightweight and balanced unit
- Twin hammer impact mechanism delivers hard hitting blows to quickly remove stubborn fasteners



PART NO.	DRIVE SIZE (inches)	MAX. TORQUE (N•m)	FREE SPEED (rpm)	BLOWS PER MINUTE
AT570	1/2	773	6,900(F), 7,000(R)	1,050
AIR CONSUMPTION, FREE SPEED (l/min)	AIR INLET THREAD SIZE	RECOMMENDED HOSE SIZE (inches)	VIBRATION LEVEL (m/s ²)	
5.0 cfm (F), 5.3 cfm (rev.)	1/4" - 18 NPT	3/8	6.08	
SOUND LEVEL dBa PRESSURE	LENGTH (mm)	WEIGHT (kg)	VINYL BOOT (optional)	
95	184	1.87	AT570BOOT	



1/2" Impact Wrench, Composite

AT5500C

Packing: 1

- Composite housing with Magnesium Nose
- Lightweight at 1.7kg
- Maximum torque of 910Nm / 671 ft. lb. of torque!
- Twin Hammer Mechanism
- Ergonomic cushion grip reduces vibration



PART NO.	DRIVE SIZE (inches)	TORQUE RANGE (N•m)	FREE SPEED (rpm)	BLOWS PER MINUTE
AT5500C	1/2	285 - 910	8,000	1,200
AIR CONSUMPTION, FREE SPEED (l/min)	AIR INLET THREAD SIZE	RECOMMENDED HOSE SIZE (inches)	VIBRATION LEVEL (m/s ²)	
7.06 cfm	1/4" - 18 NPT	3/8	4	
SOUND LEVEL dBa PRESSURE	LENGTH (mm)	WEIGHT (kg)	VINYL BOOT (optional)	
94	152	1.73	AT5500CBOOT	

3/4" Impact Wrench

AT670

Packing: 1

- Aluminium nose with composite body for lightweight & durability
- Twin-hammer mechanism easily removes stubborn nuts
- Three-position lever controls amount of torque
- Two-way push buttons controls Forward/Reverse rotation



PART NO.	DRIVE SIZE (inches)	MAX. TORQUE (N•m)	FREE SPEED (rpm)
AT670	3/4	1,423	6,700(F), 6,900(R)
BLOWS PER MINUTE	AIR CONSUMPTION, FREE SPEED (l/min)		
1,050	159		
VIBRATION LEVEL (m/s ²)	SOUND LEVEL dBa PRESSURE	LENGTH (mm)	WEIGHT (kg)
2.44	114.4	215	3.44



1/4" Drill, Micro

AT801MCA

Packing: 1

- Composite housing with new molded comfort grip is more comfortable for the user while providing less user fatigue
- Small size, light weight and a powerful motor make this tool ideal for working in confined areas
- Durable single piece polymer composite housing stands up to rugged use, resists most shop chemicals and helps insulate against the cold generated by an air tool
- Variable speed trigger



PART NO.	CHUCK SIZE (inches)	RATED POWER (kW)	TORQUE RANGE (N•m)	
AT801MCA	1/4	0.19	0 - 2	
FREE SPEED (rpm)	SPINDLE THREAD (inches)	AIR CONSUMPTION, FREE SPEED (l/min)	AIR INLET THREAD SIZE	
1,800	3/8 - 24 UNF	266	1/4" - 18 NPT	
RECOMMENDED HOSE SIZE (inches)	VIBRATION LEVEL (m/s ²)	SOUND LEVEL dBa PRESSURE	LENGTH (mm)	WEIGHT (kg)
3/8	< 2.5	96.4	183	0.68

3/8" Drill, Angle

AT811

Packing: 1

- Rugged, reversible right angle drill gets in tight spots comfortably
- Convenient one hand push button forward/reverse
- Rear exhaust keeps air away from the work area
- Built in chuck key holder keeps the key at hand for quick bit changes
- Paddle style trigger for greater comfort
- Ball bearing construction for longer tool life
- Lightweight helps avoid fatigue during prolonged use
- Bottom handle diffuse exhaust



PART NO.	CHUCK SIZE (inches)	RATED POWER (kW)	TORQUE RANGE (N•m)	
AT811	3/8	0.19	0 - 6	
FREE SPEED (rpm)	SPINDLE THREAD (inches)	AIR CONSUMPTION, FREE SPEED (l/min)	AIR INLET THREAD SIZE	
1,320	3/8 - 24 UNF	95	1/4" - 18 NPT	
RECOMMENDED HOSE SIZE (inches)	VIBRATION LEVEL (m/s ²)	SOUND LEVEL dBa PRESSURE	LENGTH (mm)	WEIGHT (kg)
3/8	< 0.8	110	208	1.1

3/8" Drill

AT3000

Packing: 1

- One hand forward/reverse operation
- Three planet gear design for durability and balance
- Bottom handle diffused exhaust
- Comfort grip handle
- Keyless chuck saves time when changing bits



PART NO.	CHUCK SIZE (inches)	RATED POWER (kW)	TORQUE RANGE (N•m)	
AT3000	3/8	0.15	0 - 4	
FREE SPEED (rpm)	SPINDLE THREAD (inches)	AIR CONSUMPTION, FREE SPEED (l/min)		
2,000	3/8 - 24 UNF	99		
AIR INLET THREAD SIZE	RECOMMENDED HOSE SIZE (inches)	VIBRATION LEVEL (m/s ²)	SOUND LEVEL dBa PRESSURE	
1/4" - 18 NPT	3/8	< 2.5	105	
LENGTH (mm)	WEIGHT (kg)	Vinyl Boot (optional)		
194	1.4	AT3000BOOT		

1/2" Drill

AT5000

Packing: 1

- One hand forward/reverse operation
- Three planet gear design for durability and balance
- Bottom handle diffused exhaust
- Comfort grip handle
- Keyed chuck easily handles 120 in.lbs. of torque
- Chuck key stores in handle



PART NO.	CHUCK SIZE (inches)	RATED POWER (kW)	TORQUE RANGE (N•m)	
AT5000	1/2	0.33	0 - 14	
FREE SPEED (rpm)	SPINDLE THREAD (inches)	AIR CONSUMPTION, FREE SPEED (l/min)	AIR INLET THREAD SIZE	
490	1/2 - 20 UNF	108	1/4" - 18 NPT	
RECOMMENDED HOSE SIZE (inches)	VIBRATION LEVEL (m/s ²)	SOUND LEVEL dBa PRESSURE	LENGTH (mm)	
3/8	< 2.5	82	229	
WEIGHT (kg)	AUXILIARY HANDLE	VINYL BOOT (optional)		
1.7	PDAH1A	AT5000BOOT		

Spotweld Drill

AT184

Packing: 1



- Twist depth control collar allows precise setting of drilling depth up to 1/4"
- Two speed trigger for low or high speeds
- Pistol grip design
- Includes one 5/16" (8 mm) drill bit and removeable clamp arm

PART NO.	CHUCK SIZE (inches)	FREE SPEED (rpm)	AIR CONSUMPTION, FREE SPEED (l/min)
AT184	5/16	1,800	238
AIR INLET THREAD SIZE	RECOMMENDED HOSE SIZE (inches)	VIBRATION LEVEL (m/s ²)	SOUND LEVEL dBa PRESSURE
1/4" - 18 NPT	3/8	< 1.0	84
LENGTH (mm)	WEIGHT (kg)	SUPPORT ARM 5.5 (optional)	
201	1.4	AT184-26A	
SPOTWELD DRILL BIT			
6.5mm (optional)	8mm (included)	10mm (optional)	
AT183-43	AT183-50	AT183-51	

1/4" Ratchet

AT203A

Packing: 1

- Lightweight aluminum housing
- Rugged ball bearing mounted air motor and precision planetary gear system
- Easy to use variable speed throttle plus adjustable air regulator



PART NO.	DRIVE SIZE (inches)	TORQUE RANGE (N•m)	FREE SPEED (rpm)
AT203A	1/4	6 - 34	285
AIR CONSUMPTION, FREE SPEED (l/min)		AIR INLET THREAD SIZE	RECOMMENDED HOSE SIZE (inches)
88		1/4" - 18 NPT	3/8
VIBRATION LEVEL (m/s ²)	SOUND LEVEL dBa PRESSURE	LENGTH (mm)	WEIGHT (kg)
< 4.4	100	188	0.57

Air Hammer

AT2050

Packing: 1



- Intended for heavy duty applications such as cutting large bolts and rivets, separating ball joints, cutting heavy gauge sheet metal and driving bushings
- Comfort grip handle
- Includes quick change retainer

PART NO.	BORE DIAMETER (inches)	BLOWS PER MINUTE	PISTON STROKE (inches)	SHANK OPENING (mm)
AT2050	3/4	3,400	2.75	10.1
AIR CONSUMPTION, FREE SPEED (l/min)	AIR INLET THREAD SIZE	RECOMMENDED HOSE SIZE (inches)	VIBRATION LEVEL (m/s ²)	
71	1/4" - 18 NPT	5/16	3.0	
SOUND LEVEL dBa PRESSURE	LENGTH (mm)	WEIGHT (kg)	VINYL BOOT (optional)	
99	187	2.1	AT2050BOOT	

1/4" Ratchet

AT200D

Packing: 1

- Lightweight aluminum housing
- Rugged ball bearing mounted air motor and precision planetary gear system



PART NO.	DRIVE SIZE (inches)	TORQUE RANGE (N•m)	FREE SPEED (rpm)
AT200D	1/4	6 - 27	150
AIR CONSUMPTION, FREE SPEED (l/min)		AIR INLET THREAD SIZE	RECOMMENDED HOSE SIZE (inches)
40		1/4" - 18 NPT	3/8
SOUND LEVEL dBa PRESSURE	LENGTH (mm)	WEIGHT (kg)	VINYL BOOT (included)
85	222	0.50	AT200D22A

1/4" Ratchet, Mini

AT204A

Packing: 1

- Compact size allows for greater access to tight spaces
- Easy to use with a variable speed throttle
- Lightweight design reduces fatigue
- Comfort grip, head boot & 5' braided PU hose



PART NO.	DRIVE SIZE (inches)	MAX TORQUE (ft.lbs)	FREE SPEED (rpm)
AT204A	1/4	30	350
AIR CONSUMPTION, FREE SPEED (l/min)	AIR INLET THREAD SIZE	RECOMMENDED HOSE SIZE (inches)	VIBRATION LEVEL (m/s ²)
99	1/4" - 18 NPT	5/16	3.6
SOUND LEVEL dBa PRESSURE	LENGTH (mm)	WEIGHT (kg)	
94	130	0.48	

3/8" Ratchet

AT704A

Packing: 1

- Lightweight aluminum housing
- Rugged ball bearing mounted air motor and precision planetary gear system
- Easy to use variable speed throttle plus adjustable air regulator



PART NO.	DRIVE SIZE (inches)	TORQUE RANGE (N•m)	FREE SPEED (rpm)
AT704A	3/8	6 - 75	200
AIR CONSUMPTION, FREE SPEED (l/min)	AIR INLET THREAD SIZE	RECOMMENDED HOSE SIZE (inches)	VIBRATION LEVEL (m/s ²)
111	1/4" - 18 NPT	3/8	< 3.9
SOUND LEVEL dBa PRESSURE	LENGTH (mm)	WEIGHT (kg)	
104	266	1.5	



3/8" Ratchet

AT7300

Packing: 1

- 70 ft.lbs of torque output to remove stubborn fasteners
- 260 RPM's for fast removal / Installation of fasteners
- Large accessible reversing knob for easy mechanism direction changes
- Robust head design for maximum strength and durability
- Adjustable exhaust directs airflow away from work area
- Soft grip handle increased comfort and reduced vibration. Insulates against cold
- Ball bearing construction and high strength alloy steel gear system prolong tool's life



PART NO.	DRIVE SIZE (inches)	TORQUE RANGE (N•m)	FREE SPEED (rpm)
AT7300	3/8	7 - 95	260
AIR CONSUMPTION, FREE SPEED (l/min)	AIR INLET THREAD SIZE	RECOMMENDED HOSE SIZE (inches)	VIBRATION LEVEL (m/s ²)
4.5 cfm	1/4" - 18 NPT	3/8	5
SOUND LEVEL dBa PRESSURE	LENGTH (mm)	WEIGHT (kg)	VINYL BOOT (included)
103	275	1.2	AT7300BOOT

3/8" Ratchet

AT700F

Packing: 1

- Lightweight aluminum housing
- Rugged ball bearing mounted air motor coupled with precision planetary gear system
- Easy to use variable speed throttle plus adjustable air regulator



PART NO.	DRIVE SIZE (inches)	TORQUE RANGE (N•m)	FREE SPEED (rpm)
AT700F	3/8	6 - 61	150
AIR CONSUMPTION, FREE SPEED (l/min)	AIR INLET THREAD SIZE	RECOMMENDED HOSE SIZE (inches)	VIBRATION LEVEL (m/s ²)
85	1/4" - 18 NPT	3/8	8.7
SOUND LEVEL dBa PRESSURE	LENGTH (mm)	WEIGHT (kg)	VINYL BOOT (included)
89	257	1.6	AT700E49A

3/8" Ratchet, High Torque

AT702

Packing: 1

- Flywheel mechanism
- Rugged ball bearing mounted air motor coupled with precision planetary gear system
- Easy to use variable speed throttle and adjustable air regulator



PART NO.	DRIVE SIZE (inches)	TORQUE RANGE (N•m)	FREE SPEED (rpm)
AT702	3/8	6 - 81	200
AIR CONSUMPTION, FREE SPEED (l/min)	AIR INLET THREAD SIZE	RECOMMENDED HOSE SIZE (inches)	VIBRATION LEVEL (m/s ²)
85	1/4" - 18 NPT	3/8	12.6
SOUND LEVEL dBa PRESSURE	LENGTH (mm)	WEIGHT (kg)	VINYL BOOT (included)
95	265	1.1	AT700E49A

1/2" Ratchet

AT705B

Packing: 1

- 1/2" drive ratchet in a 3/8" drive body
- Delivers 50 ft. lb. of maximum torque
- Ball bearing mounted motor for longer tool life



PART NO.	DRIVE SIZE (inches)	TORQUE RANGE (N•m)	FREE SPEED (rpm)
AT705B	1/2	6 - 68	150
AIR CONSUMPTION, FREE SPEED (l/min)	AIR INLET THREAD SIZE	RECOMMENDED HOSE SIZE (inches)	VIBRATION LEVEL (m/s ²)
85	1/4" - 18 NPT	3/8	8.7
SOUND LEVEL dBa PRESSURE	LENGTH (mm)	WEIGHT (kg)	VINYL BOOT (included)
89	273	1.14	AT700E49A

1/2" Ratchet

AT7350

Packing: 1

- 70 ft.lbs of torque output to remove stubborn fasteners
- 260 RPM's for fast removal / Installation of fasteners
- Large accessible reversing knob for easy mechanism direction changes
- Robust head design for maximum strength and durability
- Adjustable exhaust directs airflow away from work area
- Soft grip handle increased comfort and reduced vibration. Insulates against cold
- Ball bearing construction and high strength alloy steel gear system prolong tool's life



PART NO.	DRIVE SIZE (inches)	TORQUE RANGE (N•m)	FREE SPEED (rpm)
AT7350	1/2	7 - 95	260
AIR CONSUMPTION, FREE SPEED (l/min)	AIR INLET THREAD SIZE	RECOMMENDED HOSE SIZE (inches)	VIBRATION LEVEL (m/s ²)
4.5 cfm	1/4" - 18 NPT	3/8	5
SOUND LEVEL dBa PRESSURE	LENGTH (mm)	WEIGHT (kg)	VINYL BOOT (included)
103	275	1.2	AT7350BOOT

1/4" Die Grinder, Standard

AT115

Packing: 1

- Intended for most standard deburring operations
- Ergonomic handle grip increases comfort and control
- Safety lever throttle
- Built-in speed regulator
- Brass bearing cap and hose adaptor
- Rear diffused exhaust



PART NO.	COLLET SIZE (inches)	RATED POWER (kW)	FREE SPEED (rpm)
AT115	1/4	0.15	22,000
AIR CONSUMPTION, FREE SPEED (l/min)	AIR INLET THREAD SIZE	RECOMMENDED HOSE SIZE (inches)	VIBRATION LEVEL (m/s ²)
113	1/4" - 18 NPT	3/8	< 2.5
SOUND LEVEL dBa PRESSURE	LENGTH (mm)	WEIGHT (kg)	
102	165	0.61	

1/4" Die Grinder, Standard

AT105

Packing: 1

- Aluminum housing for long lasting durability
- Intended for most standard deburring operations
- High quality bearings improve productivity with less repair
- Rear exhaust directs air away from work area



PART NO.	COLLET SIZE (inches)	RATED POWER (kW)	FREE SPEED (rpm)
AT105	1/4	0.33	22,000
AIR CONSUMPTION, FREE SPEED (l/min)	AIR INLET THREAD SIZE	RECOMMENDED HOSE SIZE (inches)	VIBRATION LEVEL (m/s ²)
113	1/4" - 18 NPT	3/8	< 2.5
SOUND LEVEL dBa PRESSURE	LENGTH (mm)	WEIGHT (kg)	
102	165	0.61	



1/4" Die Grinder, Straight

AT1610

Packing: 1

- 22,000 RPM free speed
- Lightweight, 1.4 lbs
- 1/2 HP thermally balanced air motor
- Built-in position speed control
- Ergonomic Alcryn® comfort grip handle
- Safety style variable speed paddle trigger



PART NO.	COLLET SIZE (inches)	RATED POWER (kW)	FREE SPEED (rpm)
AT1610	1/4	0.375	22,000
AIR CONSUMPTION, FREE SPEED (l/min)	AIR INLET THREAD SIZE	RECOMMENDED HOSE SIZE (inches)	VIBRATION LEVEL (m/s ²)
3.2 cfm	1/4" - 18 NPT	3/8	1.42
SOUND LEVEL dBa PRESSURE	LENGTH (mm)	WEIGHT (kg)	VINYL BOOT (included)
99	171	0.64	AT1610BOOT



1/4" Die Grinder, 115° Angle

AT1630

Packing: 1

- 20,000 RPM free speed
- Compact design with 115° angle head
- Lightweight, only 1.7 lbs
- 1/2 HP thermally balanced air motor
- Built-in position speed control
- Ergonomic Alcryn® comfort grip handle
- Safety style variable speed paddle trigger



PART NO.	COLLET SIZE (inches)	RATED POWER (kW)	FREE SPEED (rpm)
AT1630	1/4	0.375	20,000
AIR CONSUMPTION, FREE SPEED (l/min)	AIR INLET THREAD SIZE	RECOMMENDED HOSE SIZE (inches)	VIBRATION LEVEL (m/s ²)
3.2 cfm	1/4" - 18 NPT	3/8	3.57
SOUND LEVEL dBa PRESSURE	LENGTH (mm)	WEIGHT (kg)	VINYL BOOT (included)
100.7	196	0.81	AT1630BOOT



1/4" Die Grinder, Right Angle

AT1620

Packing: 1

- 20,000 RPM free speed
- Compact design with 90° angle head
- Lightweight, only 1.7 lbs
- 1/2 HP thermally balanced air motor
- Built-in position speed control
- Ergonomic Alcryn® comfort grip handle
- Safety style variable speed paddle trigger



PART NO.	COLLET SIZE (inches)	RATED POWER (kW)	FREE SPEED (rpm)
AT1620	1/4	0.375	20,000
AIR CONSUMPTION, FREE SPEED (l/min)	AIR INLET THREAD SIZE	RECOMMENDED HOSE SIZE (inches)	VIBRATION LEVEL (m/s ²)
3.2 cfm	1/4" - 18 NPT	3/8	1.55
SOUND LEVEL dBa PRESSURE	LENGTH (mm)	WEIGHT (kg)	VINYL BOOT (included)
101.4	175	0.81	AT1620BOOT

1/4" Die Grinder, Mini, 115° Angle

AT119

Packing: 1

- 115° offset head provides a more ergonomic grinding position
- Thread-on style disc provides a more compact head
- One 2" quick-change disc included so tool is ready for your abrasive pad



PART NO.	COLLET SIZE (inches)	RATED POWER (kW)	FREE SPEED (rpm)
AT119	1/4	0.15	20,000
AIR CONSUMPTION, FREE SPEED (l/min)	AIR INLET THREAD SIZE	RECOMMENDED HOSE SIZE (inches)	VIBRATION LEVEL (m/s ²)
59	1/4" - 18 NPT	3/8	< 6.92
SOUND LEVEL dBa PRESSURE		LENGTH (mm)	WEIGHT (kg)
100		173	0.50

1/4" Die Grinder, Mini, Right Angle

AT109

Packing: 1

- Aluminum housing for long lasting durability
- Compact mini design with 90° head for easy access
- High quality bearings improve productivity with less repair
- Rear exhaust directs air away from work area



PART NO.	COLLET SIZE inches (mm)	RATED POWER (kW)	FREE SPEED (rpm)
AT109	1/4	0.15	20,000
AIR CONSUMPTION, FREE SPEED (l/min)	AIR INLET THREAD SIZE	RECOMMENDED HOSE SIZE (inches)	VIBRATION LEVEL (m/s ²)
59	1/4" - 18 NPT	3/8	2.5
SOUND LEVEL dBa PRESSURE		LENGTH (mm)	WEIGHT (kg)
93		140	0.50

1/4" Die Grinder, Mini, Right Angle

AT118

Packing: 1

- Clean dies, rotors, backing plates and brake pad mounts
- Remove gasket material
- Grind dies and valve seats
- Dress welds and enlarge holes
- Compact mini-design with 90° angled head for easy access
- Ergonomic handle grip increases comfort and control
- Safety lever throttle
- Built-in speed regulator
- Brass bearing cap and hose adaptor



PART NO.	COLLET SIZE (inches)	RATED POWER (kW)	FREE SPEED (rpm)
AT118	1/4	0.15	20,000
AIR CONSUMPTION, FREE SPEED (l/min)	AIR INLET THREAD SIZE	RECOMMENDED HOSE SIZE (inches)	VIBRATION LEVEL (m/s ²)
113	1/4" - 18 NPT	3/8	2.5
SOUND LEVEL dBa PRESSURE		LENGTH (mm)	WEIGHT (kg)
93		140	0.50

Die Grinder, Pencil

AT1070A

Packing: 1

- Twist-action variable speed control
- 5' long protected air hose
- Used with 1/8" shank grinding accessories rated higher than 54,000 RPM
- Ideal for tight spaces and easy cleaning of dies, rotors and brake pads



PART NO.	COLLET SIZE (inches)	FREE SPEED (rpm)	AIR CONSUMPTION, FREE SPEED (l/min)
AT1070A	1/8	75,000	28
AIR INLET THREAD SIZE	RECOMMENDED HOSE SIZE (inches)	VIBRATION LEVEL (m/s ²)	SOUND LEVEL dBa PRESSURE
1/4" - 18 NPT	3/8	2.0	72
LENGTH (mm)		WEIGHT (kg)	
135		0.25	

Die Grinder, Pencil, Right Angle

AT1070RA

Packing: 1

- Right angle lightweight pencil die grinder is ideal for getting in tight spaces
- Use for easy cleaning of dies, rotors, backing plates, brake pads, mounts plus many other applications
- Must be used with 1/8" shank grinding accessories rated higher than 70,000 RPM



PART NO.	COLLET SIZE (inches)	FREE SPEED (rpm)	AIR CONSUMPTION, FREE SPEED (l/min)
AT1070RA	1/8	75,000	28
AIR INLET THREAD SIZE	RECOMMENDED HOSE SIZE (inches)	VIBRATION LEVEL (m/s ²)	SOUND LEVEL dBa PRESSURE
1/4" - 18 NPT	3/8	2.0	72
LENGTH (mm)		WEIGHT (kg)	
150		0.21	

4" & 5" Die Grinder, Angle

Packing: 1

- Compact, lightweight and high performance
- Rotatable protective guard
- Aluminum alloy housing
- Ergonomic side handle
- Front exhaust
- Rotary type start switch
- Excellent for weld preparation, rust removal, deburring and blending of steel, cast iron and aluminum



PART NO.	PAD SIZE (inches)	FREE SPEED (rpm)	AIR CONSUMPTION, FREE SPEED (l/min)	LENGTH (mm)
ATGD4	4	11,000	45	235
ATGD5	5	9,500	45	235
PART NO.	AIR INLET THREAD SIZE (inches)	WEIGHT (kg)	RECOMMENDED HOSE SIZE (inches)	RATED POWER
ATGD4	1/4	2.0	3/8	470 (W), 0.63 (HP)
ATGD5	1/4	2.0	3/8	470 (W), 0.63 (HP)

Die Grinder Kit

AT109DGK

Packing: 1

- Aluminum housing
- Compact mini design
- Rear exhaust

Kit contents in storage case:
 AT109 Mini Angle Die Grinder
 2" ROLOC® pad, 1 pc
 2" Coarse discs, 2 pcs
 2" Medium discs, 2 pcs
 2" 24 grit discs, 2 pcs
 2" 36 grit discs, 2 pcs
 2" Crud discs, 2 pcs
 3" ROLOC® pad, 1 pc
 3" 50 grit discs, 2 pcs
 3" 120 grit discs, 2 pcs
 3" Crud discs, 2 pcs
 1/4" Shank adaptor, 1 pc
 Spanner wrenches, 2 pcs



PART NO.	COLLET SIZE (inches (mm))	RATED POWER (kW)	FREE SPEED (rpm)
AT109DGK	1/4	0.15	20,000
AIR CONSUMPTION, FREE SPEED (l/min)	AIR INLET THREAD SIZE	RECOMMENDED HOSE SIZE (inches)	VIBRATION LEVEL (m/s ²)
59	1/4" - 18 NPT	3/8	2.5
SOUND LEVEL dBa PRESSURE		LENGTH (mm)	WEIGHT (kg)
93		140	0.50

7" Die Grinder, Angle

ATGD7

Packing: 1

- Compact, lightweight and high performance
- 1.2 hp (895W) high performance motor
- Rotatable protective guard
- Aluminum alloy housing
- Ergonomic L/R side handle
- Rotary type start switch with safety lock
- Side exhaust
- Excellent for weld preparation, rust removal, deburring and blending of steel, cast iron and aluminum



PART NO.	PAD SIZE (inches)	FREE SPEED (rpm)	AIR CONSUMPTION, FREE SPEED (l/min)	LENGTH (mm)
ATGD7	7	7,000	79	290
PART NO.	AIR INLET THREAD SIZE (inches)	WEIGHT (kg)	RECOMMENDED HOSE SIZE (inches)	RATED POWER
ATGD7	1/4	3.31	3/8	895 (W), 1.2 (HP)

3" Cut-off Tool

AT153

Packing: 1

- Compact size is excellent for accessing areas with limited working space
- Heavy-duty bevel gears for tool longevity
- Indexing adjustable guard controls the direction of sparks
- Spindle lock eliminates the need for special wrenches for fast change of cutoff wheels
- Adjustable built-in regulator easily adjusts up to 17,000 RPM free speed



PART NO.	WHEEL SIZE (inches)	RATED POWER (kW)	FREE SPEED (rpm)	AIR CONSUMPTION, FREE SPEED (l/min)
AT153	3	0.37	17,000	99.1
AIR INLET THREAD SIZE	RECOMMENDED HOSE SIZE (inches)	VIBRATION LEVEL (m/s ²)		SOUND LEVEL dBa PRESSURE
1/4" - 18 NPT	3/8	< 2.86		85
LENGTH (mm)	WEIGHT (kg)	3" CUTTER WHEELS (OPTIONAL)		
185	1.5	1/16" thick, 36 grit	1/32" thick, 54 grit	3/32" thick, 54 grit
		AT150-20A	AT150C28A	AT150C29A

3" Cut-off Tool, Reversible

AT157R

Packing: 1

- Ideal for use in body shops and other general automotive applications
- Recommended for cutting mufflers, hose clamps, bolts and sheet metal
- Uses wheels only rated above 18,000 RPM
- Spark direction control
- Safety throttle lever
- Rear diffused exhaust
- Comfort grip handle



PART NO.	WHEEL SIZE (inches)	RATED POWER (kW)	FREE SPEED (rpm)	AIR CONSUMPTION, FREE SPEED (l/min)
AT157R	3	0.33	20,000	99
AIR INLET THREAD SIZE	RECOMMENDED HOSE SIZE (inches)	VIBRATION LEVEL (m/s ²)		SOUND LEVEL dBa PRESSURE
1/4" - 18 NPT	3/8	< 3.8		100
LENGTH (mm)	WEIGHT (kg)	3" CUTTER WHEELS (OPTIONAL)		
185	0.86	36 grit	54 grit	
		AT150-20A	AT150-29A	

2" Grinder, Angle

AT215

Packing: 1

- Ideal for body shops, automobile, truck repair and confined areas
- Grease fitting in head enables gears to be greased for longer tool life
- Includes 6 2" wheels - tool is ready for use providing convenience
- Moveable guard, up to 50° in either direction-fitting various applications
- Built in speed regulator allows user to set desired speed
- Rear exhaust with rotating deflector
- Comfort grip housing insulate from cold and vibration for less user fatigue
- Safety lever throttle prevents accidental start ups for increased safety



PART NO.	WHEEL wSIZE (inches)	RATED POWER (kW)	FREE SPEED (rpm)	AIR CONSUMPTION, FREE SPEED (l/min)
AT215	2	0.37	15,000	85
AIR INLET THREAD SIZE	RECOMMENDED HOSE SIZE (inches)	VIBRATION LEVEL (m/s ²)		SOUND LEVEL dBa PRESSURE
1/4" - 18 NPT	3/8	< 2.86		73
LENGTH (mm)	WEIGHT (kg)	GRINDING DISC (optional)		
188	0.82	AT215GWSET		

4 1/2" Grinder, Compact

AT415B

Packing: 1

- 4 1/2" Compact grinder
- Includes (1) 4 1/2" diameter x 3/16" thick grinding disc



PART NO.	WHEEL SIZE (inches)	RATED POWER (kW)	FREE SPEED (rpm)	AIR CONSUMPTION, FREE SPEED (l/min)
AT415B	4 1/2	0.64	12,000	91
AIR INLET THREAD SIZE	RECOMMENDED HOSE SIZE (inches)	VIBRATION LEVEL (m/s ²)	SOUND LEVEL dBa PRESSURE	
1/4" - 18 NPT	3/8	5.1	87	
LENGTH (mm)	WEIGHT (kg)	GRINDING DISC		
254	1.9	AT415A51		

Reciprocating Saw, Micro

AT194A

Packing: 1

- Compact size for easy access in tight quarters
- Low vibration level and lightweight yields reduced hand fatigue
- Performs straight or scroll cuts on metal or plastic
- Adjustable blade guard to control cutting depth
- Flexible, guarded hose extension helps prevent damage to finished surface and aids in maneuverability
- Blade change wrenches and guard adjustment
- Safety trigger prevent accidental start



PART NO.	FREE SPEED (rpm)	AIR CONSUMPTION, FREE SPEED (l/min)	AIR INLET THREAD SIZE	
AT194A	8,250	20	1/4" - 18 NPT	
RECOMMENDED HOSE SIZE (inches)	VIBRATION LEVEL (m/s ²)	SOUND LEVEL dBa PRESSURE	LENGTH (mm)	WEIGHT (kg)
3/8	< 6.6	87	175	0.45
BI-METAL BLADE, 5PK, 3 3/34" LONG				
18TPI	24TPI	32TPI		
AT190-39A	AT190-40A	AT190-41A		

Reciprocating Saw

AT192A

Packing: 1

- Adjustable blade guard to control cutting depth
- Comfort grip housing for greater control
- Performs straight or scroll cuts in metal and plastic
- Safety lever throttle
- Optional blades in 4" lengths are also available



PART NO.	FREE SPEED (rpm)	AIR CONSUMPTION, FREE SPEED (l/min)	AIR INLET THREAD SIZE	
AT192A	11,000	28	1/4" - 18 NPT	
RECOMMENDED HOSE SIZE (inches)	VIBRATION LEVEL (m/s ²)	SOUND LEVEL dBa PRESSURE	LENGTH (mm)	WEIGHT (kg)
3/8	10.1	94	235	0.80
BI-METAL BLADE, 5PK, 3 3/34" LONG				
18TPI	24TPI	32TPI		
AT190-39A	AT190-40A	AT190-41A		

Air Powered Shears

AT195

Packing: 1

- Trims, outlines and shears
- Replaceable brass filter screen
- Built-in speed regulator



PART NO.	AIR CONSUMPTION, FREE SPEED (l/min)	AIR INLET THREAD SIZE	RECOMMENDED HOSE SIZE (inches)
AT195	113	1/4" - 18 NPT	3/8
VIBRATION LEVEL (m/s ²)	SOUND LEVEL dBa PRESSURE	LENGTH (mm)	WEIGHT (kg)
< 2.5	99.6	254	1.3

Nibbler

AT180C

Packing: 1

- Cuts mild steel sheet up to 16 gauge, 0.62" thick
- Anvil is adjustable for forward, backward and left or right cutting, enabling the nibbler to make sheet metal cuts of any configuration
- Readily cuts most non-ferrous materials including aluminum, brass, formica, laminates, fiberglass and masonite



PART NO.	FREE SPEED (rpm)	AIR CONSUMPTION, FREE SPEED (l/min)	
AT180C	3,500	113	
AIR INLET THREAD SIZE	RECOMMENDED HOSE SIZE (inches)	VIBRATION LEVEL (m/s ²)	
1/4" - 18 NPT	3/8	4.3	
SOUND LEVEL dBa PRESSURE	LENGTH (mm)	WEIGHT (kg)	STANDARD PUNCH
97	193	0.88	AT180B-10

In Line Sander, Heavy Duty

AT475A

Packing: 1

- 5/8" stroke
- Minimal vibration
- For fast material removal
- Pad has positive locking clamps



PART NO.	FREE SPEED (rpm)	AIR CONSUMPTION, FREE SPEED (l/min)	AIR INLET THREAD SIZE
AT475A	1,800	65	1/4" - 18 NPT
RECOMMENDED HOSE SIZE (inches)	VIBRATION LEVEL (m/s ²)		SOUND LEVEL dBa PRESSURE
3/8	14.9		87
LENGTH (mm)	WEIGHT (kg)	STANDARD PAD	
406	3.09	AT475A-29	

Belt Sander

AT615

Packing: 1

- Grinding head pivots 360° for increased flexibility
- Simple belt tracking adjustment knob to adjust belt slack
- Powerful 0.5 hp for long lasting performance
- Belt guard detaches for quick abrasive changes
- Ergonomic 7° off set handle and lightweight design minimizes operator fatigue

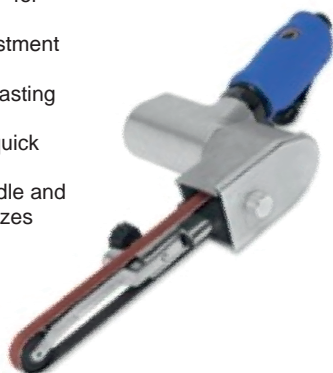

PART NO.	RATED POWER (kW)	FREE SPEED (rpm)	
AT615	0.3	20,000	
AIR CONSUMPTION, FREE SPEED (l/min)	AIR INLET THREAD SIZE	RECOMMENDED HOSE SIZE (inches)	
119	1/4" - 18 NPT	3/8	
VIBRATION LEVEL (m/s ²)	SOUND LEVEL dBa PRESSURE	LENGTH (mm)	WEIGHT (kg)
1.36	95	359	1.20

Belts

Packing: 5



PART NO.	DESCRIPTION	SIZE (inches)	GRIT
ATBA381860	Coated Abrasive	3/8 x 18	60 Grit
ATBA381880		3/8 x 18	80 Grit
ATBA3818120		3/8 x 18	120 Grit
ATBA121860		1/2 x 18	60 Grit
ATBA121880		1/2 x 18	80 Grit
ATBA1218120		1/2 x 18	120 Grit
ATBA341860		3/4 x 18	60 Grit
ATBA341880		3/4 x 18	80 Grit
ATBA3418120		3/4 x 18	120 Grit
ATBB121850		Nonwoven Abrasive	1/2 x 18
ATBB1218100	1/2 x 18		100 Grit
ATBB1218240	1/2 x 18		240 Grit
ATBB341850	3/4 x 18		50 Grit
ATBB3418100	3/4 x 18		100 Grit
ATBB3418240	3/4 x 18		240 Grit
ATBB381850	3/8 x 18		50 Grit
ATBB3818100	3/8 x 18		100 Grit
ATBB3818240	3/8 x 18		240 Grit

6" Sander, Dual Action

AT411A

Packing: 1

- For fine sanding operations and swirl free finishing
- Comfort handle helps reduce fatigue
- Converts from rotary to random orbit action by sliding drive plate
- Built-in thumb wheel speed regulator



PART NO.	PAD SIZE (inches)	RATED POWER (kW)	FREE SPEED (rpm)	
AT411A	6	0.37	10,000	
SPINDLE THREAD (inches)	AIR CONSUMPTION, FREE SPEED (l/min)	AIR INLET THREAD SIZE	RECOMMENDED HOSE SIZE (inches)	
5/16 - 18 UNC	142	1/4" - 18 NPT	3/8	
VIBRATION LEVEL (m/s ²)	SOUND LEVEL dBa PRESSURE	LENGTH (mm)	WEIGHT (kg)	STANDARD PAD
3.7	79	203	2.14	AT411A-1

8" Sander, Dual Action

AT408

Packing: 1

- Comfort handle helps reduce fatigue
- Rear diffused exhaust
- Built-in adjustable speed regulator
- Variable speed control
- Removable brass filter screens out debris



PART NO.	PAD SIZE (inches)	RATED POWER (kW)	FREE SPEED (rpm)	
AT408	8	0.37	850	
SPINDLE THREAD (inches)	AIR CONSUMPTION, FREE SPEED (l/min)	AIR INLET THREAD SIZE	RECOMMENDED HOSE SIZE (inches)	
5/16 - 24	142	1/4" - 18 NPT	3/8	
VIBRATION LEVEL (m/s ²)	SOUND LEVEL dBa PRESSURE	LENGTH (mm)	WEIGHT (kg)	STANDARD PAD
3.7	87	281	2.18	AT408-2

5" Sander Reversible, High Speed

AT425R

Packing: 1

- Use in body shops and other general automotive applications
- Includes 3", 4" and 5" backing discs
- One hand forward / reverse lever
- Comfort grip handle
- Built-in speed regulator
- 1 year limited warranty on tool
- No warranty on consumables
- CE-DE, ES, FR, IT, GB



PART NO.	PAD SIZE (inches)	RATED POWER (kW)	FREE SPEED (rpm)
AT425R	5	0.33	13,000
SPINDLE THREAD (inches)	AIR CONSUMPTION, FREE SPEED (l/min)	AIR INLET THREAD SIZE	RECOMMENDED HOSE SIZE (inches)
7/16 - 20 UNC	122	1/4" - 18 NPT	3/8
VIBRATION LEVEL (m/s ²)	SOUND LEVEL dBa PRESSURE	LENGTH (mm)	WEIGHT (kg)
< 0.8	93	135	1.28
STANDARD PAD	REPLACEMENT PADS (OPTIONAL)		
5"	3"	4"	
AT425R-24	AT425R-22	AT425R-23	

Polisher, Heavy Duty, Vertical

AT460BP

Packing: 1

- Removable side handle



PART NO.	PAD SIZE (inches)	RATED POWER (kW)	FREE SPEED (rpm)	SPINDLE THREAD (inches)
AT460BP	7	0.49	4,500	5/8 - 11
AIR CONSUMPTION, FREE SPEED (l/min)	AIR INLET THREAD SIZE	RECOMMENDED HOSE SIZE (inches)	VIBRATION LEVEL (m/s ²)	
136	1/4" - 18 NPT	3/8	< 2.5	
SOUND LEVEL dBa PRESSURE	LENGTH (mm)	WEIGHT (kg)	STANDARD PAD	SPANNER WRENCH (opt.)
83	185	2.27	AT450-46H	AT450-50

3" Surface Prep Tool, Micro

AT401MCA

Packing: 1

- Small size, light weight and a powerful motor
- Ideal for removing paint, rust, gasket material, grinding welds or brake rotors in confined areas
- Accepts 2" and 3" ROLOC® pads
- Pads attach/release with just a 1/4 turn
- Durable single piece polymer composite housing on prep tool stands up to rugged use, resists most shop chemicals and helps insulate against the cold generated by an air tool
- Oversize trigger for easy operation
- Variable speed trigger
- Bottom handle diffused exhaust
- Built-in speed regulator offers easy one hand operation



Surface Prep Kit, Micro, 13pcs

AT401MCKA

Packing: 1

- Storage case packaging, Kit includes:
 AT401MCA micro surface prep tool
 2" ROLOC® pad, 1 pc 3" ROLOC® pad, 1 pc
 2" 40 grit pads, 5 pcs 3" 80 grit pads, 5 pcs

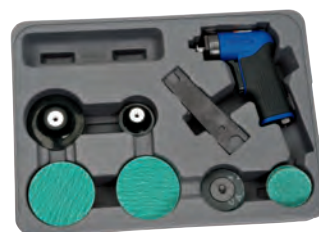

PART NO.	PAD SIZE (inches)	RATED POWER (kW)	FREE SPEED (rpm)	SPINDLE THREAD (inches)	AIR CONSUMPTION, FREE SPEED (l/min)	AIR INLET THREAD SIZE	RECOMMENDED HOSE SIZE (inches)	VIBRATION LEVEL (m/s ²)	SOUND LEVEL dBa PRESSURE	LENGTH (mm)	WEIGHT (kg)
AT401MCA	3	0.19	15,000	1/4 - 20 UNF	59	1/4" - 18 NPT	3/8	< 2.5	84	119	0.44

3" Sander, Dual Action, Micro

AT402MCA

Packing: 1

- Delivers fine swirl free results when sanding, feather edging, scuff sanding, sanding primer surfaces, top coating surface preps, scuffing door and rocker panel jams plus other finesse sanding applications
- Durable single piece polymer composite housing on sander stands up to rugged use, resists most shop chemicals and helps insulate against the cold generated by an air tool
- Oversize trigger for easy operation
- Variable speed trigger
- Bottom handle diffused exhaust
- Built-in speed regulator is easily operated with one hand



3" Sander Kit, Micro, Dual Action, 72pcs

AT402MCKA

Packing: 1

- Storage case packaging, Kit includes:
 AT402MCA micro sander
 3" Hook-It® pad, 1 pc 3" 180 grit pads, 25 pcs
 3" 200 grit pads, 25 pcs 3" 320 grit pads, 10 pcs
 3" 800 grit pads, 25 pcs



PART NO.	PAD SIZE (inches)	RATED POWER (kW)	FREE SPEED (rpm)	SPINDLE THREAD (inches)	AIR CONSUMPTION, FREE SPEED (l/min)	AIR INLET THREAD SIZE	RECOMMENDED HOSE SIZE (inches)	VIBRATION LEVEL (m/s ²)	SOUND LEVEL dBa PRESSURE	LENGTH (mm)	WEIGHT (kg)
AT402MCA	3	0.19	15,000	5/16 - 24 UNF	59	1/4" - 18 NPT	3/8	< 2.5	84	133	0.50



3" Polisher, Micro

AT403MCA

Packing: 1

- Small size, light weight and a powerful motor
- Ideal for polishing motorcycles, bumpers, wheels and more
- Durable single piece polymer composite housing on polisher stands up to rugged use, resists most shop chemicals and helps insulate against the cold generated by an air tool
- Oversize, variable speed trigger for easy operation with a gloved hand
- Bottom handle diffused exhaust
- Built-in speed regulator offers easy one hand operation



3" Polisher Kit, Micro, 5pcs

AT403MCKA

Packing: 1

- Storage case packaging, Kit includes:
 AT403MCA micro polisher
 3" Hook-It® pad, 1 pc 3" wool pad, 1 pc
 3" foam pad, 2 pcs



PART NO.	PAD SIZE (inches)	RATED POWER (kW)	FREE SPEED (rpm)	SPINDLE THREAD (inches)	AIR CONSUMPTION, FREE SPEED (l/min)	AIR INLET THREAD SIZE	RECOMMENDED HOSE SIZE (inches)	VIBRATION LEVEL (m/s ²)	SOUND LEVEL dBa PRESSURE	LENGTH (mm)	WEIGHT (kg)
AT403MCA	3	0.19	6,000	5/16 - 24 UNF	62	1/4" - 18 NPT	3/8	< 2.5	86	143	0.60

Pistol Air Screwdriver 2500rpm

ATSD25

Packing: 1

- Pistol type screwdriver
- Cushion Clutch
- Reversible one-hand operation
- Composite molded housing, light weight
- Adjustable torque
- Comfortable Ergo-grip handle
- Trigger with feathering, variable speed
- Low roll back reaction



PART NO.	SCREW SIZE CAPACITY (mm)	MAX.TORQUE (Nm)	FREE SPEED (rpm)	AIR CONSUMPTION, FREE SPEED (l/min)	LENGTH (mm)	AIR INLET THREAD SIZE	NET WEIGHT (kg)	SOUND LEVEL dBa PRESSURE
ATSD25	6	17	2,500	283	212	1/4	1.08	88

POWER TOOLS

Pneumatic Tools / Sanders & Finishing Tools / Impact Screwdrivers



Straight Air Screwdriver

Straight Air Screwdriver 1450rpm

ATSD15

Packing: 1

- Straight type screwdriver
- Cushion Clutch
- Adjustable torque
- Reversible button with lock on feature & throttle lever start
- Lightweight
- Quick torque adjustment



PART NO.	SCREW SIZE CAPACITY (mm)	MAX.TORQUE (Nm)
ATSD15	5	5
FREE SPEED (rpm)	AIR CONSUMPTION, FREE SPEED (l/min)	LENGTH (mm)
1,450	170	279
AIR INLET THREAD SIZE	WEIGHT (kg)	SOUND LEVEL dBa PRESSURE
1/4	0.97	75

Straight Air Screwdriver 1900rpm

ATSD19

Packing: 1

- Straight type screwdriver
- Cushion Clutch
- Adjustable torque
- Reversible & lever start
- Lightweight
- Quick torque adjustment



PART NO.	SCREW SIZE CAPACITY (mm)	MAX.TORQUE (Nm)
ATSD19	5	5
FREE SPEED (rpm)	AIR CONSUMPTION, FREE SPEED (l/min)	LENGTH (mm)
1,900	127	229
AIR INLET THREAD SIZE	WEIGHT (kg)	SOUND LEVEL dBa PRESSURE
1/4	1.01	85

173 WARNING



- Use only impact sockets and accessories with impact wrenches
- Read safety precautions on page 220

Pocket Blow Gun

BLPPBG14

Packing: 1

- Light weight and easy operation
- Portable pencil style design
- It could be the inflator with rubber tip
- Max input pressure: 150PSI
- Max output pressure: 90PSI
- Air flow: 450 L/m
- Plug type: ARO, TRU-FLATE, Universal 1/4" pipe threading



Blow Gun

JT13B

Packing: 1

- Tapered, rubber tip for a leak proof connection between gun and fluid line
- Vinyl coated control lever
- Hanging hook for storage
- 4 1/2" long



Blow Gun

YA105020

Packing: 1

- 20" bent nozzle
- Trigger provides variable air flow control
- Lightweight body with ergonomically designed grip provides comfort and control
- Insulated handle prevents cold hands
- Venturi tip directs air sideways if tip end is obstructed
- Reinforced 1/4"-18NPT inlet
- Maximum air pressure: 232 PSI (16 BAR)



Blow Gun

YA1050B

Packing: 1

- Pistol grip style with front full size trigger
- Infinitely variable flow
- 10 1/4" long



Blow Gun

YA1055B

Packing: 1

- Each gun includes hanging hook and paddle-type air control lever
- Variable flow trigger offers precise air flow control
- Six-outlet "star tip" delivers an even distribution of air
- 4" Full Flow tube and ergonomic handle for increased comfort
- Triggers regulate airflow from partial to full line pressure
- Maximum Working Pressure: 175 PSI (12 bar)
- Complies with OSHA safety standards
- Valve has no cutoff and no restrictions
- Each tip is side vented
- Air Inlet: 1/4" NPT



Regulator, Combination Air Line

AHRB200

Packing: 1



PART NO.	INLET/OUTLET PORT SIZE	ADJUSTABLE PRESSURE RANGE
AHRB200	1/2" NPT (F)	5 - 120 psig (0.5 - 8.5 kgf/cm ²)
MAXIMUM SERVICE PRESSURE	OIL CAPACITY	OPERATING TEMPERATURE RANGE PRESSURE
140 psig (9.9 kgf/cm ²)	80ml	41° - 140° F (5° - 60° C)

Carbide Burr Set, 8pcs

BLPCBS8

- Nylon pouch with logo printing packaging
- Made of tungsten carbide K25 material
- Most popular burr style for ferrous applications
- Flutes ground in both the left and right hand directions
- Better operator control and rapid stock removal in harder materials
- Designed for surface milling and contouring in brass, copper, cast iron, carbon steels, stainless steel, steel elements and titanium



Packing: 1

CONTENTS	BURR DESCRIPTION	SHANK SIZE (inches)	FLUTE LENGTH (inches)	HEAD DIAMETER (inches)
CBC-1	Cylindrical	1/4	5/8	1/4
CBCR-2	Cylindrical with radius end		3/4	3/8
CBB-3	Ball shaped		1/4	5/16
CBO-4	Oval		7/8	1/2

CONTENTS	BURR DESCRIPTION	SHANK SIZE (inches)	FLUTE LENGTH (inches)	HEAD DIAMETER (inches)
CBTR-5	Tree with radius end	1/4	1	1/2
CBTP-6	Tree with pointed end		3/4	3/8
CBAT-7	14° included angle taper		1 1/8	1/2
CBC-8	Cone shaped		7/8	1/2

Grinding Wheel Set

ETA125A

Packing: 1

- Use with ET1350/ET1360
- Maximum rating of 12,000 RPM
- Pack of 5 discs



Cut Off Wheel

AT415CWMP

Packing: 1

- Use for metal notching and bolt cutting
- Use on 4 1/2" grinders with 5/8" x 11" thread arbor
- Maximum rating of 13,300 rpm
- Front and back illustrated
- Pack of 5 discs



Grinding Wheel

AT415T27MP

Packing: 1

- Use for rough grinding applications
- Use on 4 1/2" grinders with 5/8" x 11" thread arbor
- Maximum rating of 13,300 rpm
- Pack of 5 discs



Flap Discs

Packing: 1



PART NO.	DIAMETER (inches)	TYPE	GRIT	QUANTITY TO PACK
AC2Z40T27MP	2	27	40	10
AC2Z60T27MP	2	27	60	10
AC2Z80T27MP	2	27	80	10
AC4Z60T27MP	4	27	60	10

Flap Wheels

Packing: 1

- Applications include cleaning, edge blending and smoothing metal, plastic or wood
- 3" aluminum oxide flap wheel is designed to provide fast cutting action
- 1/4" stem on solid hub permits a higher RPM rating and increased productivity
- Use on electric and pneumatic drills

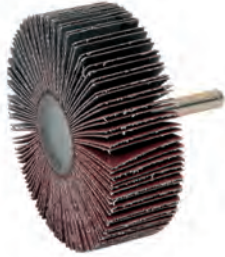

PART NO.	DIAMETER (inches)	GRIT	QUANTITY TO PACK
AC3160FWMP	3	60	10
AC3180FWMP	3	80	10
AC31120FWMP	3	120	10

Wire Wheel, Crimped, 3"

AC616

Packing: 1

- A great general purpose cleaner
- Features individual crimped filaments that support each other while being flexible
- General applications include deburring, weld cleaning, rust and paint removal
- Use on electric and pneumatic drills
- 0.0118 CWS-1/4



PART NO.	BRUSH DIAMETER (inches)	SHANK SIZE ARBOR SIZE (inches)	WIRE DIAMETER (inches)	MAXIMUM RATED (rpm)
AC616	3	1/4	0.118	20,000

Wire Wheel, Knotted

Packing: 1

- Use for heavy duty cleaning
- Ideal for pre-welding prep and weld cleaning



PART NO.	BRUSH DIAMETER (inches)	SHANK SIZE ARBOR SIZE (inches)	WIRE DIAMETER (inches)	MAXIMUM RATED (rpm)
AC420A	4	5/8 x 11	0.020	20,000
AC421A	4	M10 x 1.25	0.020	20,000

POWER TOOLS Accessories

End Brush

Packing: 1

- Features individual crimped filaments that support each other while being flexible
- Ideal for cleaning right angles



PART NO.	BRUSH DIAMETER (inches)	SHANK SIZE ARBOR SIZE (inches)	WIRE DIAMETER (inches)	MAXIMUM RATED (rpm)
AC10302	1/2	1/4	0.014	25,000
AC10306	3/4	1/4	0.014	22,000

Wire Brush

Packing: 1

- Features individual crimped filaments that support each other while being flexible
- Use for medium duty general purpose cleaning



PART NO.	BRUSH DIAMETER (inches)	SHANK SIZE ARBOR SIZE (inches)	WIRE DIAMETER (inches)	MAXIMUM RATED (rpm)
AC17D	1	1/4	0.006	20,000
AC243	3	5/8 - 11	0.014	14,000

Wool Velcro Pad

ABU10-050

Packing: 1

- 8" x 25" Wool Velcro Pad
- Ideal for cutting, buffing, and removal of scratches and paint imperfections
- 1 1/2" wool pile last longer than standard wool pads
- Washable for easy clean up
- Use for base and clear coats, acrylic, enamel, lacquer, urethane, fiberglass, plastics and other applications



Air Hoses

AIRHOSE35

Packing: 1

- Extremely lightweight for easy maneuverability
- Reinforced construction eliminates layer separation resulting from expansion and contraction during pulsating operations



- More abrasion resistant than PVC and rubber hoses
- Easy to wrap and store even in subzero weather
- UV stabilized for longer outdoor life
- Strain relief features a tight bending radius to virtually eliminate hose kinking
- Reusable fittings and strain reliefs for longer life

Step Drill Set, 3pcs

YAS203A

Packing: 1



PART NO.	CONTENT	HOLE SIZES PER BIT	INCREMENTS (inches)	LENGTH (inches)	SHANK SIZE (inches)	SIZE RANGE (inches)
YAS203A	YA261A	13	1/32	3 1/4	1/4	1/8 - 1/2
	YA262A	6	1/16	3 3/8	1/4	3/16 - 1/2
	YA263A	9	1/16	2 5/8	3/8	1/4 - 3/4

Cobalt Drill Bit Set, 21pcs

DBBPC21

Packing: 1

- DBBPC1/16 thru DBBPC3/8 (1/16" to 3/8") in metal drill bit index



HSS Drill Bit Set, 21pcs

DBBP21

Packing: 1

- DBBP1/16 thru DBBP3/8 (1/16" to 3/8") in metal drill bit index



Titanium Coated Drill Bit Set, 13pcs

DBBPT13

Packing: 1

- DBBPT1/16 thru DBBPT1/4 (1/16" to 1/4") in metal drill bit index



Air Line Couplers & Adaptors

Packing: 1

- All adaptors are plated steel to improve durability

PART NO.	DESCRIPTION	BODY SIZE (inches)	STYLE	THREAD SIZE (inches)
AHC21PD*	Quick Coupler Female	1/4	Rigid Mounting	1/4 - 18 NPT
AHC21PMD	Quick Coupler Male	1/4	Industrial Interchange	1/4 - 18 NPT
AHC21D	Quick Coupler Female			
AHC21MD	Adaptor Male			
AHC21FD	Adaptor Female			
AHC23PMD	Quick Coupler Male	1/4	ARO®	1/4 - 18 NPT
AHC23D	Quick Coupler Female			
AHC23MD	Adaptor Male			
AHC23FD	Adaptor Female			
AHC24D	Quick Coupler Female	1/4	Tru-Flate®	1/4 - 18 NPT
AHC24MD	Adaptor Male			
AHC24FD	Adaptor Female			
AHC26D	Quick Coupler Female	1/4	Lincoln	1/4 - 18 NPT
AHC26MD	Adaptor Male			
AHC26FD	Adaptor Female			
AHC22E	Quick Coupler Female	3/8	Industrial Interchange	1/4 - 18 NPT
AHC22MD	Adaptor Male			
AHC22FD	Adaptor Female			
AHC28D	Quick Coupler Female	3/8	Industrial Interchange	3/8 - 18 NPT
AHC28MD	Adaptor Male			
AHC28FD	Adaptor Female			
AHC25D	Quick Coupler Female	3/8	Tru-Flate®	3/8 - 18 NPT
AHC25MD	Adaptor Male			
AHC27D	Quick Coupler Female	1/2	Industrial Interchange	1/2 - 18 NPT
AHC27MD	Adaptor Male			
AHC27FD	Adaptor Female			
AHCC91C	Quick Coupler Male	1/4	Hi-Flow HVLP	1/4 - 18 NPT
AHCC90C	Quick Coupler Female			
AHCCP90C	Adaptor Female			
AHCCP97C	Adaptor Male			



AHC21PD



AHC21MD



AHC23PMD



AHC24MD



AHC26D



AHC22MD



AHC28MD



AHC27MD

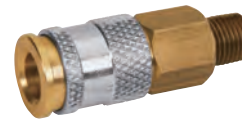

AHCC91C



AHCC90C



AHCCP90C



AHCCP97C

* Conforms to Mil Spec MIL-C-4109F

MEASURING & INSPECTION TOOLS

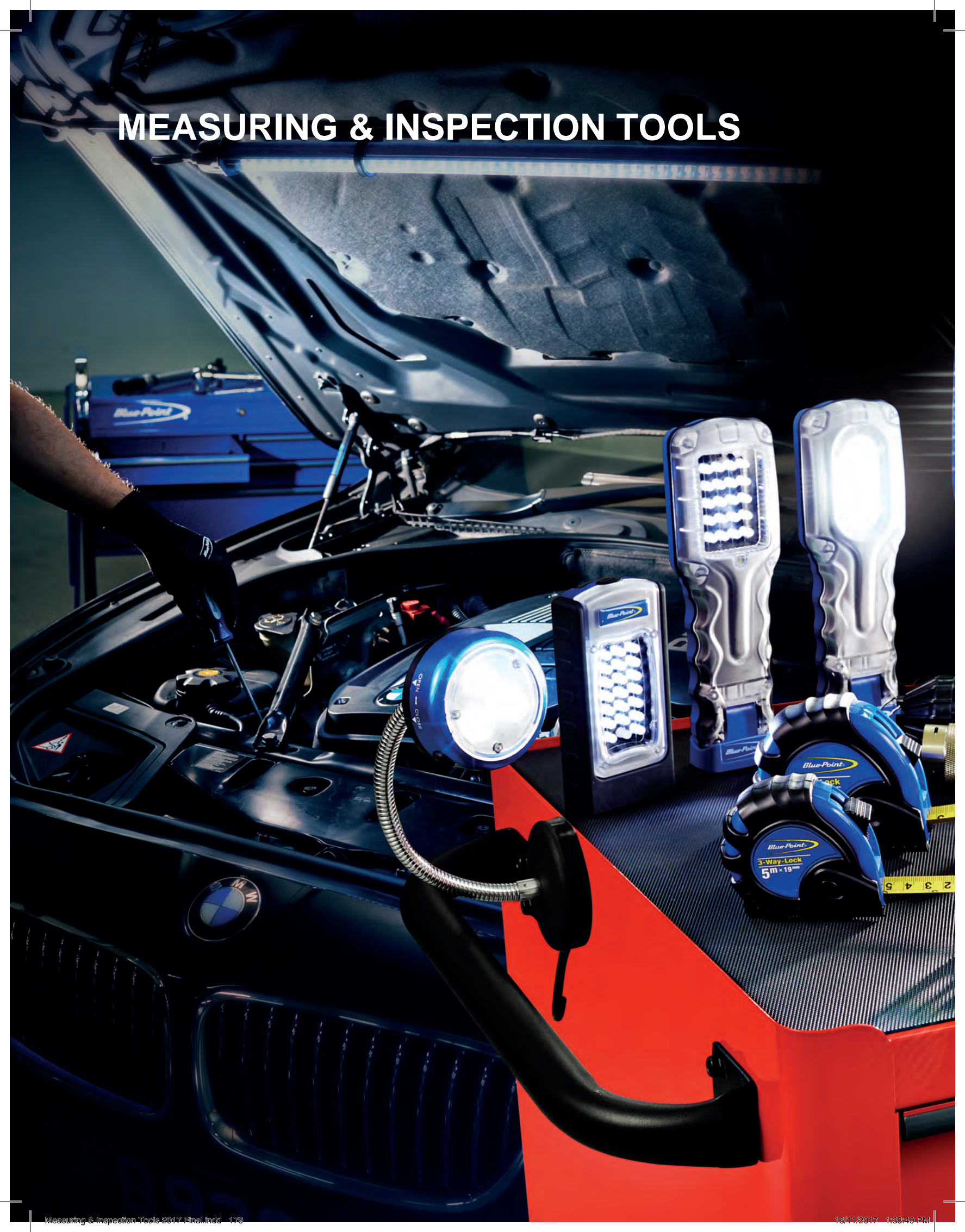

Blue-Point[®]

Advanced Lighting, Imaging & Measuring



Feeler Gauges, 13pcs

FB310B

Packing: 1



Feeler Gauges, 25pcs

FB325A

Packing: 1



Feeler Gauges, 35pcs

FB335

Packing: 1



PART NO.	INCREMENTS	BLADE SIZE	STYLE	BLADE DIMENSIONS (inches)	NO. OF BLADES	DESCRIPTION
FB310B	-	.001", .0015", .002" thru .008", .010", .012", .013", .015"	General Use	1/2 x 3	13	Double stamped with U.S. and metric sizes
FB325A	.001"	.0015", .002" thru .025"	General Use	1/2 x 3	25	Double stamped with U.S. and metric sizes
FB335	.001"	.0015", .002" thru .035"	General Use	1/2 x 3	35	Swedish feeler blade steel

Feeler Gauges, 18pcs

FB316B

Packing: 1



Feeler Gauges, 20pcs

FBM320

Packing: 1



Feeler Gauges, 25pcs

FBL325A

Packing: 1

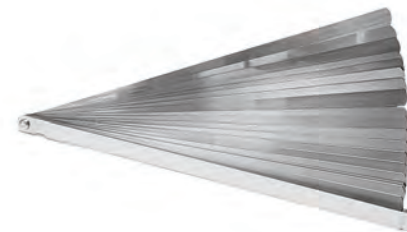

PART NO.	INCREMENTS	BLADE SIZE	STYLE	BLADE DIMENSIONS (inches)	NO. OF BLADES	DESCRIPTION
FB316B	.001"	.010", .012", .013", .015" thru .022", .024" thru .026", .028", .030", .032", .035"	Short Blade Ignition / Spark Plug Gauge	1/4 x 1 3/4	18	Short Blade, Ignition / Spark Plug Gauge Set
FBM320	.05mm	.05 thru 1mm	Metric General Use	1/2 x 3	20	Metric Feeler Gauge Set
FBL325A	.001"	.0015", .002" thru .021", .025", .027", .030", .040"	Long Blade General Use	1/2 x 12	25	Long blade, double stamped with U.S. and metric sizes

Feeler Gauges, 12pcs

FB308D

Packing: 1



Feeler Gauges, 25pcs

FB300A

Packing: 1



Feeler Gauges, 26pcs

FB326B

Packing: 1



PART NO.	INCREMENTS	BLADE SIZE	STYLE	BLADE DIMENSIONS (INCHES)	NO. OF BLADES	DESCRIPTION
FB308D	.001"	.008"-.010", .011"-.013", .013"-.015", .014"-.016", .015"-.017", .017"-.019", .018"-.020", .020"-.022", .023"-.025", .025"-.027", .026"-.028", .028"-.030"	Step Blade	1/2 x 3	12	Step Feeler Gauge Set, Bent handle to clear manifolds, double stamped with U.S. / Metric sizes. Blades are mounted on FBFT7 holder
FB300A	.001"	.006" thru .030"	Bent Blade	1/2 x 3	25	Feeler Gauge Set
FB326B	.001"	.008", .010", .012", .013", .015", .017", .018", .020", .022", .024" thru .026", .028", .030", .032", .035"	Combination Feeler / Ignition Gauge	1/2 x 3	26	Double stamped with U.S. and metric sizes

Feeler Gauges, 2pcs

FB328A

Packing: 1



Feeler Gauges, 2pcs

FBM322

Packing: 1



Feeler Gauges, 22pcs

FB322

Packing: 1



PART NO.	INCREMENTS	BLADE DIMENSIONS (inches)	BLADE SIZE	NO. OF BLADES	DESCRIPTION
FB328A	-	1/2 x 3	.011"-.013", .013"-.015"	2	For valve adjustment on GM 8.2L engines, double stamped with U.S. and metric sizes
FBM322	-	1/2 x 3	.20-.30mm, .40-.50mm	2	i.e. 10 3/4" long bent handle
FB322	.001"	1/2 x 3 3/8	.004"-.006" thru .025"-.027"	22	"Go-No Go" blades with 2 sizes each

Feeler Gauges, 14pcs

FB307D

Packing: 1

- Bent blade cummins diesel, blade ends are bent at 90° angle
- Blades are secured on FB307C1 ring



PART NO.	INCREMENTS	BLADE DIMENSIONS (inches)	BLADE SIZE	NO. OF BLADES
FB307D	.001"	1/2 x 4 1/2	.008", .011" thru .014", .016" thru .018", .020", .023" thru .025", .027", .029"	14

Measuring Tapes

Packing: 1

- Rubberized coating for better grip
- Tape auto-lock when extended
- Nylon coated tape



PART NO.	LENGTH (meter)
BMPLM3	3
BMPLM5	5

Dividers, 6"

CNT6521

Packing: 1

- Spring type divider has virtually no torsion or side play



Feeler Gauges, 20pcs

BLPFG20

Packing: 1

- Material: C45
- Shiny surface



Long Tape, Steel, 100ft

TPM100

Packing: 1

- Includes inch and metric scale
- Quick rewind design for ease of use
- Rewinding lever conveniently stored in housing
- Non-slip grip provides confidence and comfort



Angle Locator

YA328A

Packing: 1

- Precise, accurate tool to determine angle measurements
- Ideal for checking drive shaft angle
- Red degree indicator located behind numbers for exact reading of graduations
- English and metric scales molded into base of tool in 1/8" and DM
- Large 1 7/8" x 7/8" magnet inserted in base for secure retention

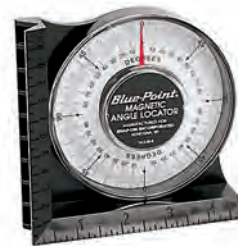

Digital Caliper

MCAL6A

Packing: 1

- Gauge is 0" to 6" (0 to 150mm) in 0.0005" (0.01mm) resolutions
- Use for inside, outside, depth and step measurements
- Inch/metric conversion with one button
- Large LCD display
- Hardened stainless steel frame
- Conform to standard : GB1214



Digital Caliper

MCAL12A

Packing: 1

- Essential tool for working on larger vehicles, trucks, tractors and earth moving equipment
- Range is 0" to 12" (0 to 305mm) in 0.0005" (0.01mm) resolutions
- Use for inside, outside, depth and step measurements
- Inch/metric conversion with one button
- Large LCD display with floating zero set
- Locking nut and thumb roll for smooth action
- Conform to standard : GB1214



Magnetic Holder

CM6416

Packing: 1

- Magnet has "on/off" switch
- Base is 2 3/8" x 1 7/8" x 2 1/2"
- Post is 7" x 15/16"
- Rod is 6" x 25/64"
- Will grip flat or curved metal surfaces

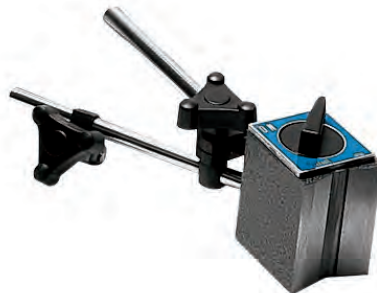

Dial Type Caliper

PMF147A

Packing: 1

- Gauge is 0" to 6" in high (0.001" increments) and metric (0.1mm increments)
- Includes storage case
- Conform to standard : GB1214



Combination Measuring Set

SQUARECOMB12

Packing: 1

- Storage case packaging



Machinist's Measuring Set

SQUAREB12

Packing: 1

- Storage case packaging



PART NO.	CONTENTS
SQUARECOMB12	SQUAREB180 Square Protractor Head
	RULER12BSQ Steel Ruler, 12"
	SQUAREB90 Square Sliding Head
	SQUAREB45 Square Sliding Head 45°

PART NO.	CONTENTS
SQUAREB12	SQUAREB90 Square Sliding Head
	RULER12BSQ Steel Ruler, 12"

Digital Micrometers



Packing: 1

PART NO.	RANGE (mm)	INCREMENTS (mm)
MIC1MB	0-25	0.01
MIC2MB	25-50	0.01
MIC3MB	50-75	0.01
MIC4MB	75-100	0.01
MIC5MB	100-125	0.01
MIC103MB	Digital Metric Micrometer Set, 3pcs MIC1MB, MIC2MB, MIC3MB in fitted case with standards	

Digital Micrometers



Packing: 1

PART NO.	RANGE (inches)	INCREMENTS (inches)
MIC1B	0-1	0.0001
MIC2B	1-2	0.0001
MIC3B	2-3	0.0001
MIC4B	3-4	0.0001
MIC5B	4-5	0.0001
MIC103B	Digital Micrometer Fractional Set, 3pcs MIC1B, MIC2B, MIC3B in fitted case with standards	

Outside Micrometers



Packing: 1

PART NO.	RANGE (inches)	INCREMENTS (inches)
MICB1B	0-1	0.0001
MICB2B	1-2	0.0001
MICB3B	2-3	0.0001
MICB4B	3-4	0.0001
MICB5B	4-5	0.0001
MICB103B	SAE Set, 3pcs MICB1B, MICB2B, MICB3B in fitted case with standards	

Electronic Digital Micrometers

MICED1B

Packing: 1

- Display reads to 0.00005" (0.001mm)
- Zero set for absolute and incremental measuring modes
- Auto shut-off after 10 minutes
- Insulated frame, hardened body, carbide tipped anvil, positive locking clamp and ratchet stop thimble



Inside Micrometer Set, 7pcs

MICINSIDE12

Packing: 1

- Tubular design
- Range is 2" to 12" in .001" increments
- Includes inside micrometer head and a series of coil spring pressure contact rods



Depth Micrometer Set

DM6

Packing: 1

- Measure depths of slots, counterbores, holes and keyways up to 6" in depth
- 4" satin chrome base for greater stability
- Graduated in .001" increments
- Includes fitted storage case

PART NO.	DESCRIPTION
DM61	4" rod
DM62	5" rod
DM63	6" rod
DM64	7" rod
DM65	8" rod
DM66	9" rod
DM67	Micrometer Head



Steel Rule, 15cm

BLPSR15

Packing: 1

- Material: C45



Thermometer

ACT73A

Packing: 1

- Range 0° F to 220° F (-18° C to 105° C) in 2° increments
- Checks temperature of condenser, outside air, and cooling power



Dial Type Thermometer

ACT83A

Packing: 1

- Range 0° F to 220° F in 2° increments
- Storage case
- Stem should be immersed about 2" in liquids, 4" in gases



Pocket Digital Thermometer

TEMP10

Packing: 1

- Measures liquid, air and surface temperatures via sturdy stainless steel probe
- Digital display for easy viewing
- Angle viewing head can be lifted and rotated 180° for a different viewing angle
- Convertible from Fahrenheit (F) to Centigrade (C) temperature ranges
- The -58° F to 300° F (-50° C to 150° C) temperature range enables use on a wide range of applications
- Tactile on/off button for easy operator use (auto off function extends battery life)
- Tactile data hold button holds the reading when the display cannot be seen
- Temperature range noted on bevel
- Plastic carrying sheath protects the user when carried in shirt pocket



Infrared Thermometer

RTEMPB3A

Packing: 1

- Temperature range of -58° to 932°F (-20°C to 500°C)
- Use for most automotive and industrial applications requiring an infrared thermometer
- Compact size of 5.88" x 3.62" x 1.38" (149.2 x 92.1 x 34.9mm)
- Laser targeting accuracy
- Enhanced backlit 4 digit LCD for easy viewing
- Automatic power-off after 10 seconds
- Nylon holster for transport and safe storage
- Safely monitor hot, hazardous, or hard to reach materials without contamination or damage to the surface
- Simply point at target, pull the trigger, and read the temperature on the large, backlit LCD display



Antifreeze Hydrometer

AF102

Packing: 1

- Degree of protection is indicated by direct reading-no temperature compensating scales are required
- Range of +32°F to -60°F
- Includes Celsius scale
- Tests hot and cold solutions



NEW! Digital Tire Inflator

BLPDTPG175

Packing: 1

- Easy change chuck system
- 1 button operation
- Auto shut-off for increased battery life
- Displays KgF, BAR, PSI, KPA measurements
- Large face LCD digital read-out
- Unit covered with rubber sleeve for extra comfort and durability
- ON power Button, auto shut off in 90 seconds if not in use
- LCD backlight
- 2-position lever – 1st position deflates, 2nd position inflates
- With 21" hose
- 2 AAA batteries



Dial Tire Gauge

PG60

Packing: 1

- 12" flex hose and bleeder valve
- Dual scale pressure range – 60 psi, 410 kPa
- 1% accuracy
- Swivel angle chuck
- Ideal for automobile and light truck service



Dial Tire Inflator / Gauge

TIF160

Packing: 1

- 1% accuracy allows for use on vehicles equipped with TPMS sensors
- Shorter hose and body length make this gauge ideal for use on cars and light trucks
- Rugged dial and plunger style mechanism preserve gauge accuracy when dropped
- Stainless Steel Braided Hose
- 6-160 PSI, 60-1100kPa



Pressure Gauge

TPGIF1600

Packing: 1

- 10 to 120 PSI in 2 pound increments 1/4"
- 1/4" FNPT air inlet fitting
- Swiveling hose for easy gauge positioning
- Zinc body with heavy duty brass valves
- Easy to read sight glass featuring PSI and kPa readings



Pressure Gauge

TPGP120

Packing: 1

- Calibrated in 2 psi increments from 20 to 150 PSI and in 10 kPa increments from 150 to 800 kPa
- Chrome plated
- 5 3/4" long



Tread Depth Gauge

GA599A

Packing: 1

- Measures to a depth of 1" in 1/32" increments
- Plastic body with aluminum probe and sliding gauge
- Includes pocket clip



Air Adjusting Valve, with Gauge

BF555

Packing: 1

- Designed for use with HVLP spray guns
- Includes 160 PSI pressure gauge
- Air Inlet: 1/4" M.P.T
- Air Outlet: 1/4" F.P.T. (swivel nut)



Brake Gauge Set

BTG8

Packing: 1

- Color coded gauges provide instant feedback on brake pad/shoe condition
- Constructed from 20 gauge sheet metal with durable powder coat finish
- Pad/shoe condition is indicated with color by the respective testing gauge
- Set includes 8 different testing blades of various colors and thickness

RED Indicates service required	YELLOW Indicates caution	GREEN Indicates an OK situation
Blade Thickness		
2mm (0.0787") 3mm (0.1181")	4mm (0.1575") 5mm (0.1969") 6mm (0.2362")	8mm (0.3150") 10mm (0.3937") 12mm (0.4724")



Gauge Set

FBS5

Packing: 1



PART NO.	CONTENTS
FBS5	FB300A Bent Blade Feeler Gauge
	FB305A Non-magnetic Feeler Gauge
	FB325A General Use Feeler Gauge
	GA461B Spark Plug Gap Gauge
	FB360B Spark Plug Gap Gauge
	FBS5-1 Kit Bag

Rotor Micrometer

RM130

Packing: 1

- Range of .30" to 1.3" in .0001" graduations
- 3.5" deep frame
- Pointed anvil for checking grooves
- Includes 1" checking standard and storage case



Brake Caliper Kit, 7pcs

YA8610B

Packing: 1

- Set includes one tool and seven adaptors in a storage case
- Assists in replacement of brake pads on most 4-wheel disc brake cars
- Tool and adaptors position brake piston back into caliper to allow clearance for newer, thicker brake pads
- Designed for most Audi, Chrysler Corporation, Ford, GM, Honda, Jaguar, Mazda, Mini Cooper, Mitsubishi, Nissan, Saturn, Subaru, Toyota, Volkswagen and Volvo



Digital Drum Gauge

DG530

Packing: 1

- Measures automotive and heavy duty brake drums
- Pointed anvils and 4.25" long arms allow increased measurement accuracy and coverage
- Easy to read digital display with inch/metric conversion
- Selectable depth stops for easier use
- Range 6"-20.65"/150mm-515mm
- Graduations .0005"/.01mm



Brake Spring Tool

BT9

Packing: 1

- Quickly and easily removes or replaces springs
- Allows mechanics to press spring into place with one simple motion, taking the place of the slide mechanism
- Includes two mechanisms to allow easy removal and replacement of springs on brakes
- Patent pending
- 8 3/4" long



Brake Caliper Press

BTCP1

Packing: 1

- Easy left and right side use
- Works on both fixed and floating calipers
- Generates more than 1600 ft. lbs. of force to retract the toughest caliper pistons
- Single lever mechanism used to apply and release force for ease of operation and faster service
- Prevents damage to pistons, hubs or calipers
- Ensures parallel piston retraction on dual and quad piston calipers



Penlight, Blue

ECFB200BL

Packing: 1

- High intensity 3 watt LED, 100 lumen penlight
- 6.25" in length and 1/2" in diameter
- Includes pocket clip and protective rubber tip
- Extremely bright light output
- Uses (3) AAA alkaline batteries



Penlight, Black

BLPFL1LAP

Packing: 1

- Lightweight portable LED penlight with metal clip
- 1 LED providing 25 lumens
- Lighting distance up to 18m
- Runtime : 12 hours on two AAA batteries



Aluminum Police Style Flashlight

ECF201A

Packing: 1

- 3 watt LED flashlight features a K2 Luxeon LED that produces 130 lumens
- The flashlight body is aerospace grade extruded aluminum with heavy anodization
- Average run time is 10-hours on 2D alkaline batteries
- Reflector is highly polished for maximum light output
- Requires 2 "D" cell batteries (not included)
- The switch is self cleaning
- Water and shock resistant



Compact Flashlight

BLED1

Packing: 1

- Adjustable beam by sliding zoom
- Anodized aluminum casing
- LED type : CREE XP-E-R2
- Luminance flux:195mm
- Switch mode: High Light, Low Light, Strobe, SOS
- Uses (3) AAA alkaline batteries
- Waterproof grade: IPX6



SPECIFICATION

Lamp	1 LED	Battery Type	2xAA alkaline batteries included
Luminous Flux	25lm	Size	12.9x1.6cm
Lighting Distance	18m	Material	Aluminum + Metal Clip
Runtime	12h	Weight	25g (without batteries)



Bendable Light

ECF1600

Packing: 1

- Heavy duty barrel handle and switch
- Features 10 flexible shaft and 3/16" high intensity lamp
- Includes (2) AA batteries



168 LED Under Hood Light

ECUB168AP

Packing: 1

- Special design with double injection handle
- 168 SMD LED supply 1250 lumens
- Adjustable aluminum holder
- Robust, shock resistant housing
- Cable 25' long



Rechargeable Slim Bender Light

ECFSLIMDAP

Packing: 1

- Slim and bendable design
- 10 LED supply 280 lumens
- Magnets on light and charger secure to ferrous surfaces
- Charge indicator on light reflects battery state of charge



LED Compact Shop Light

ECFHKYAP

Packing: 1

- Small pocket size housing
- 6 LED supply 350 lumens
- Close to 360° rotatable
- Strong magnetic on bottom



LED Flood Light

ECFFLOODAP

Packing: 1

- 1 COB LED supply two level of brightness; high 1600 lm, low 800 lm
- Sealed COB LED provide excellent light resources
- IP65 rating for water proof



Flexible Magnetic SMD LED Work Light

ECFLEX3

Packing: 1

- Brightness: 110 Lumens
- Strong magnetic base with hang hook
- Sturdy aluminium housing with (3) 0.5W SMD LED lights
- Heavy duty spring adjusts light beam to needed angle with limitless positions
- Comes with (3) AAA batteries



Magbender 6 SMD LED Work Light

ECFBP6

Packing: 1

- IP65-resistant to water and dust in filtration
- 180° hinge for mounting flexibility
- Two brightness settings 100% and 50% for longer time
- USB charger and cable included for easy charging anywhere



PART NO.	LIGHT OUTPUT	BATTERY	RUN TIME	CHARGING TIME
ECFBP6	450LUX (0.5 M)	3.7V Li-ion 2000mAh	3 hours	4-5 hours

LED Headlight

ECFHEAD1A

Packing: 1

- LED headlight for applications requiring hands free lighting
- Bright watt LED never needs replacing
- Pivoting head and adjustable headband
- Water resistant
- 30 hours continuous run time on (3) AAA alkaline batteries



Battery Tester

BLPBTP612

Packing: 1

- Integrated thermal printer battery tester
- Designed for testing all types of 6V and 12V starter batteries, including lead-acid, gel and AGM, Bad cell detection capability
- Voltmeter mode for testing both the starter and the charging system, Anti-sparking clamps for safe operation
- Back-lit Display, 4 Lines 16 Characters LCD for easy viewing
- Designed with the technician in mind, the button layout and housing allows for one-handed operation
- Test Range : 100-1400 CCA
- Starter system testing: pressing the down arrow displays the captured voltage from cranking the engine
- Charging system testing: pressing the up arrow displays the captured high voltage from the alternator
- Detachable Test Lead: 50cm/2"
- Screen Size: 76mm x 39mm
- Voltmeter: 7.6V ~ 17V via Battery Clamp
- Weight: 0.52kg
- Clamp Size: 90mm
- Multi Languages Display: English, German, Italian, Portuguese



Battery Charger, Shop

BLPBBC200

Packing: 1

- **Smart** – microprocessor controlled, prevent overcharged
- **Usage** – 12V lead acid, AGM, deep cycle and gel cell. 200A booster
- **Different charging modes** – express, fast and trickle
- **Damage prevention** – reverse polarity, short circuit and overheat



Borescope

BKB6500

Packing: 1



PART NO.	OPTIMAL VIEWING
BKB6500	1" to 12" (2.5 cm – 30 cm)
POWER SUPPLY	ESTIMATED BATTERY RUN TIME
Li-Ion Battery 3.7V, 4200 mAh	3-5 hours
WEIGHT	INTERNAL MEMORY
1lbs 14oz. (0.5 kg)	512 MB storage
BUILT IN MICRO SD CARD BAY	DIMENSIONS
high capacity compatible	7" (17.8 cm) L x 3.63" (9.2 cm) W x 6.25" (15.9 cm) H
TEMPERATURE	HUMIDITY
2°F to 113°F (0°C to 45°C)	5% to 95% non-condensing (display unit)
STORAGE TEMP	WATER RESISTANCE
-4°F to 158°F (-20°C to 70°C)	Imager to 10' (3.05 m) depth

- 4.3" TFT LCD Display with a native resolution of 480 RGB X 240
- Digital camera technology provides superior imagery under all light conditions compared to analog cameras
- Dual view Imager allows the user to see forward or 90° to the side with one touch
- Easy to use touch screen interface
- File naming for convenient file management
- Text annotation aids in documentation
- Coil cord imager handle allows for greater maneuverability while the base stays at a comfortable viewing position
- Low optical distortion provides superior image quality
- Capture still images at 640 X 480 resolution
- Capture video at a rate of 20 fps (frames per second)
- 2X digital zoom
- Excellent near-field focus (0.5" to 12")
- Imaging head made of robust aluminium
- Resistant to common automotive and industrial chemicals
- Super Bright LED
- 8.5mm outside diameter fits in most spark plug holes
- Built in microphone and speaker for recording comments and sounds
- 36" long imager is coated with a non conductive covering for protection of surfaces and safety
- Mini-USB connector for uploading images and video to a computer
- Analog video out to a larger format screen or recording device
- Rubber over-mold on all contact/gripping areas for added ergonomics and durability
- Integrated rubberized magnets secure unit to metal surfaces
- External microSD Card access
- External mini-USB access
- Integrated three position stand for added convenience
- Rechargeable internal Lithium-ion battery
- D/C plug allows the unit to be used while battery is being charged

Borescope

- Optimal focal length of 1/2 inch
- High intensity LED light



1 Dual Lens, straight and 90° for all round viewing flexibility



2 New digital imager improves image clarity and brightness, water resistant up to 3m



3 External and internal memory with video output



5 New wider 4.3" screen with touchscreen controls

4 Rechargeable Lithium battery

Automatic Meter

MT454C

Packing: 1

- MT454C is a durable, easy to use compact size digital multimeter
- Compact size fits comfortably in the palm of your hand
- Easy-to-read 4000 count digital display
- Automatically selects correct function of DC Volts, AC Volts or Ohms (Resistance)
- Use DC Voltage ranges to verify proper voltage level is arriving at a sensor or circuit
- Measure Ohms to determine resistance of a coil
- Also test resistance of fuses, fusible links, components and circuits
- Measure AC voltage signals on digital MAF sensors plus wheel and vehicle speed sensors
- Protective boot with tilt stand, test leads, battery and instruction manual included
- 5 year limited warranty

Meter Manual Ranging

MT501C

Packing: 1

- MT501C ergonomic, compact size fits comfortably in the palm of the hand
- Measure Ohms to determine resistance of a coil or spark plug wire
- Also test continuity of fuses, fusible links, components and circuits
- Use DC voltage ranges to verify proper voltage level is arriving at a sensor or circuit
- Easy-to-read, 2000 count LCD display
- Lock readings on display with data hold
- Measure AC voltage signals on digital MAF sensors plus wheel and vehicle speed sensors
- Added protection against drops and the elements with included rubber boot
- Safety cULus 3111 Listed. Meets CE and IEC 1010 safety standards
- 5 year limited warranty

Meter Autoranging

MT574C

Packing: 1

- MT574C offers both automatic and manual ranging
- Measure Ohms to determine resistance of a coil or spark plug wire
- Use the diode function to test the diode pack on a typical alternator
- Use DC voltage ranges to verify proper voltage level is arriving at a sensor or circuit
- Easy-to-read, 4000 count LCD display with low battery indication
- Lock readings on display with data hold
- Measure AC voltage signals on digital MAF sensors plus wheel and vehicle speed sensors
- Measure DC current to determine presence of a parasitic load
- Added protection against drops and the elements with included rubber boot
- Safety cULus 3111 Listed. Meets CE and IEC 1010 safety standards
- 5 year limited warranty



PART NO.	DISPLAY COUNT	AC / DC VOLTS	BASIC DC ACCURACY	AC / DC AMPS (mA)	RESISTANCE (Ohm)	AUTO RANGE	DATA HOLD	MIN / MAX	AUTO POWER OFF	CE OR UL LISTED	CAT RATING
MT454C	4,000	600 / 600	0.50%	— / —	40M	YES	—	—	YES	CE, cULus 3111	CATIII 600 Volt
MT501C	2,000	600 / 600	0.75%	— / —	2K	—	YES	—	—	CE, cULus 3111	CATIII 600 Volt
MT574C	4,000	600 / 600	0.30%	400 / 400	40M	YES	YES	YES	YES	CE, cULus 3111	CATIII 600 Volt

Automatic Meter



Multimeter, General

MT132AP

- Measures voltage up to 600V AC/DC, DC current, resistance and diode test.
- Large backlit LCD display with data hold and relative zero mode
- Protective rubber guards for drop protection
- Designed to safely and accurately troubleshoot a variety of industrial and household electrical problems
- CATIII safety standards complied and CE certified

Packing: 1



Automotive Amp Meter

EECT72

Packing: 1

- Allows easy component testing and parasitic drain location
- Real time readings of current in fused circuit without removing fuse or a snapshot
- Special fuse adapters lock on to fuse to give user hands free control or use the standard probes



PART NO.	CASE	OPERATING VOLTAGE	AMPERAGE RANGE
EECT72	Nylon Pouch	6V, 12V, 24V	5mA to 50A
MINIMUM DETECTABLE CURRENT	SMALL SCALE RESOLUTION	LARGE SCALE RESOLUTION	
5ma for 5A fuse, 50ma for 50A fuse	.01A (10mA)	.1A (100mA)	
FUSE TYPE/RANGE*			
MINI (atm) MICRO (atr)/LP	STANDARD (atc)	MAXI	
5A, 7.5A, 10A, 15A, 20A, 25A, 30A	5A, 7.5A, 10A, 15A, 20A, 25A, 30A	30A, 40A, 50A	
ACCURACY	BATTERY POWERED	BATTERY LIFE	
+/- 5% of display	3 x AA Alkaline Battery (not Included)	Approx. 500 hrs of continuous use	
AUTO-OFF	BANANA JACKS	SIZE	
After Approx. 10 minutes of inactivity	Standard 4mm Safety shrouded Jacks	5.5"x3.5"x1.5"	
WEIGHT	OPERATING TEMPERATURE	TEST LEADS	
0.5 lbs	20°F - 120°F	36" 1000V CATIII 10A	

Universal EFI Quick Probe

YA76462

Packing: 1

- Quickly detects electronic fuel injector functions on any gas or diesel engine
- Specifically designed to detect the vibrations emitted when the electronic injector fire[®]
- No hunting for injector wires to the connector
- No need to remove the injector
- Super bright LED strobe
- 7" removable probe tip
- Battery operation
- Sensitivity thumb wheel



Probe, Coil-On-Plug

YA76562

Packing: 1

- Super bright KV & ARC indicator LEDs
- 7" signal receiver probe
- Battery operated
- Sensitivity thumb-wheel



Circuit Tester

BPECT1

Packing: 1

- Circuit tester for 6 and 12 volt systems
- Quickly and safely tests high and low voltages on all vehicles including computerized engine
- Can be used to detect power, ground and find shorts and breaks
- High impedance to protect sensitive electronic sensors, microprocessors, electronic ignition components and air bags
- LED indicates red for power (high) and green for ground (low)
- Insulated alligator clip



Fuse Buddy Pro Test Kit

EEFB310

Packing: 1

- Great tool for reading circuit amperage draws and troubleshooting up to 30 amps
- Kit includes 1 meter with 3 interchangeable test functions: 30 amp MINI circuit current test, 30 amp ATC circuit current test and 30 amp all purpose current test
- Plugs directly into MINI and ATC fuse sockets
- Additional 30 amp test clips expand the testing capability
- Original fuse is replaced in-line, thereby maintaining circuit protection
- Easy connection into fuse socket, Fuse Body™ end is shaped like a fuse
- LCD display features analog bar graph
- Unit also features Data Hold and Auto Power-Off
- Measuring Range: 0 - 30 Amps/48 VDC-10 seconds
- Accuracy: ± 2% of reading
- Resolution: 100 mA



Mini Engine Electronic Stethoscope

YA6910

Packing: 1

- Sensor clamp helps to detect noises during test drives that can not be duplicated in the work bay
- Sensor tip mounted on 6" flexible shaft allows access to reach difficult areas
- 5" inductive metal probe allows user to pinpoint source of noise or vibration
- Ultra sensitive microphone provides a full range of sound
- Rotary volume control allows easy adjustment
- Ear-bud style earphones provide excellent sound quality



Max Fuse Buddy®

EEFB315

Packing: 1

- MAXI circuit testing capability up to 80 Amps
- Also works with ATC and mini circuits-includes adapters
- Large LCD display with analog bar graph
- Unit powered by 9 volt battery, features peak hold functions
- Accuracy: + 2.0% of reading + 4 digits
- One touch zero function
- Amps: 0 - 80 Amps DC
- Resolution: 0.1A



Gas / Diesel Combustion Leak Tester

GDCT16

Packing: 1

- Provides an easy and quick way to diagnose engine overheating problems
- Checks for leaks between the combustion chamber and the cooling system
- Test head and gasket for combustion leaks before removing the radiator
- Double chamber in testing unit provides a high level of accuracy
- For use on water cooled gas and diesel engines
- Kit includes complete test chamber, 16 oz. bottle of testing fluid and instructions



Battery Carrier

BL1B

Packing: 1

- For top post and side terminal batteries
- Rubber pads securely grip battery widths from 5" to 7"
- Plastic hand grip provides a firm hold



Test Pen, 250VAC

BLTP1

Packing: 1

- Voltage Test Range: 110-250V



Inspection Mirrors

Packing: 1



PART NO.	MIRROR DIAMETER (inches)	LENGTH (inches)
UIM125	1 1/4	6 1/2, extendable to 35
UIM225	2 1/4	6 1/2, extendable to 35
UIM325	3 1/4	6 1/2, extendable to 29 1/2

Terminal Tool Kit

TT12KT

Packing: 1

- Applications include most GM and other domestic computer connectors and terminals. Individual handles for easy access in tight places. Designed for weather pack and pack-con terminals with flat blade to open connectors and fork for ALDL connectors to access trouble codes. Color coded: Red handle for GM and Green for wire terminal tools. Includes storage case
- Kit includes these GM C3 System Terminal Tools (red handle):
 Tube, Spring Loaded, 3.3mm x 28mm
 Square Blade, 1.4 x 19.00mm
 Flat Blade, 1.5 x 24.75mm
 Flat Blade, 2.0 x 23.00mm
 Fork Blade, 8.0 x 24.00mm
 Flat Blade Screwdriver, 3/16" x 1.00"
- Kit includes these Wire Terminal Tools (green handle):
 Tube, 3.30 x 28.0mm
 Tube, 4.30 x 13.0mm
 Tube, 3.75 x 13.0mm
 Tube, 3.00 x 13.0mm
 Flat Twin Blade, 3.0mm
 Flat Twin Blade, 1.6mm



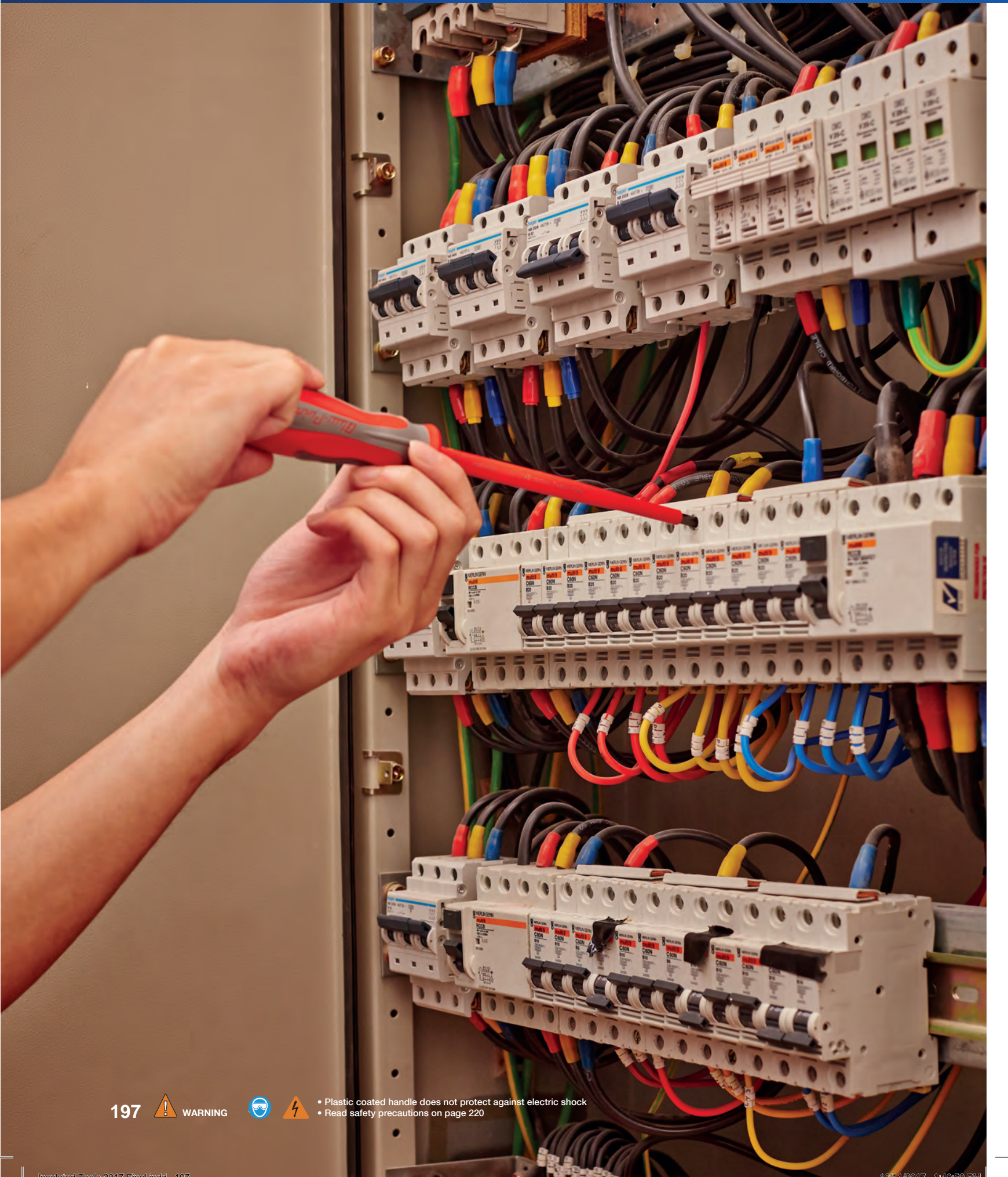



Insulated Ring Wrench Set, 21pcs

BLPISDRW21SET

Packing: 1

- Tools are VDE certified with certificate
- Made from high impact resistance injection for increased connection for torque
- Insulation material are anti-burn with high low temperature resistance
- Test up-to 10000v with GS/VDE certification IEC 60900:2012

Set includes:

- 6, 7, 8, 9, 10, 11, 12, 13, 14, 15, 16, 17, 18, 19, 21, 22, 24, 27, 30, 32mm
- Insulated Scissor – 160mm
- In foam cut kit

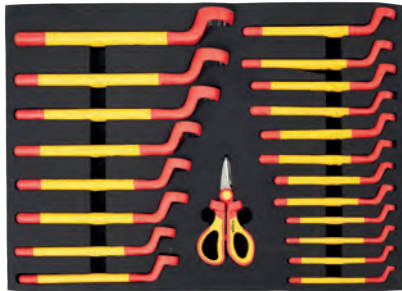

Insulated Wrench Set, 37pcs

BLPISD37SET

Packing: 1

- Tools are VDE certified with certificate
- Made from high impact resistance injection for increased connection for torque
- Insulation material are anti-burn with high low temperature resistance
- Test up-to 10000v with GS/VDE certification IEC 60900:2012

Set includes:

- Insulated Open Wrench - 6, 7, 8, 9, 10, 11, 12, 13, 14, 15, 16, 17, 18, 19, 21, 22, 24, 27, 30, 32mm
- Insulated Ratcheting Wrench - 10, 11, 12, 13, 14, 15, 16, 17, 18, 19mm
- Insulated Hex Key – 3, 4, 5, 6, 8, 10mm
- In foam cut kit

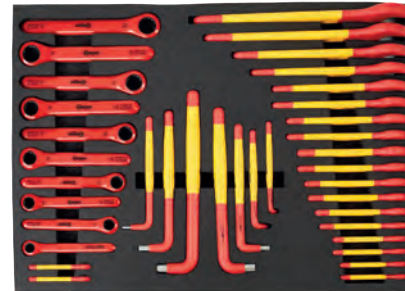

Insulated Socket Toolbox Set, 20pcs

BLPISDS20SET

Packing: 1

- Suitable for automotive electric and hybrid cars servicing
- Tools are VDE certified with certificate
- Made from high impact resistance injection for increased connection for torque
- Insulation material are anti-burn with high low temperature resistance
- Test up-to 10000v with GS/VDE certification IEC 60900:2012

Set includes:

- ½" Insulated Socket – 10, 11, 12, 13, 14, 17, 19, 22, 24, 27, 32mm
- ½" Insulated Bit Socket – 4x120, 5x120, 6x120, 8x120, 10x120mm
- ½" Insulated T Wrench – 200mm
- ½" Insulated Ratchet – 250mm



Insulated Toolbox Set, 20pcs

BLPISD20SET

Packing: 1

- Suitable for automotive electric and hybrid cars servicing
- Tools are VDE certified with certificate
- Made from high impact resistance injection for increased connection for torque
- Insulation material are anti-burn with high low temperature resistance
- Test up-to 10000v with GS/VDE certification IEC 60900:2012

Set includes:

- Insulated Open Wrench - 6, 7, 8, 9, 10, 11, 12, 13, 14, 15, 16, 17, 18, 19, 21, 24, 27, 30, 32mm
- Insulated Adjustable Wrench – 250mm





1/2" Insulated Socket, mm

BLPISDRW21SET

Packing: 1

- 1/2" Drive
- Tools are VDE certified with certificate
- Made from high impact resistance injection for increased connection for torque
- Insulation material are anti-burn with high low temperature resistance
- Test up-to 10000v with GS/VDE certification IEC 60900:2012



PART NO.	Size (mm)	Length (mm)
BLPISD1210	10mm	54
BLPISD1211	11mm	
BLPISD1212	12mm	
BLPISD1213	13mm	
BLPISD1214	14mm	
BLPISD1217	17mm	
BLPISD1219	19mm	
BLPISD1222	22mm	
BLPISD1224	24mm	
BLPISD1227	27mm	
BLPISD1232	32mm	



1/2" Insulated Bit Socket, mm

BLPISDRW21SET

Packing: 1

- 1/2" Drive
- Tools are VDE certified with certificate
- Made from high impact resistance injection for increased connection for torque
- Insulation material are anti-burn with high low temperature resistance
- Test up-to 10000v with GS/VDE certification IEC 60900:2012



PART NO.	Size (mm)
BLPISD124120	4x120mm
BLPISD125120	5x120mm
BLPISD126120	6x120mm
BLPISD128120	8x120mm
BLPISD1210120	10x120mm



1/2" Insulated Extension Bars

Packing: 1

- Tools are VDE certified with certificate
- Made from high impact resistance injection for increased connection for torque
- Insulation material are anti-burn with high low temperature resistance
- Test up-to 10000v with GS/VDE certification IEC 60900:2012



PART NO.	Size (mm)
BLPISDEXT125	4x120mm
BLPISDEXT250	5x120mm



1/2" Insulated T-Wrench

BLPISDT200

Packing: 1

- 200mm length
- Tools are VDE certified with certificate
- Made from high impact resistance injection for increased connection for torque
- Insulation material are anti-burn with high low temperature resistance
- Test up-to 10000v with GS/VDE certification IEC 60900:2012





Insulated Adjustable Wrench

BLPISDADJ10

Packing: 1

- Tools are VDE certified with certificate
- Made from high impact resistance injection for increased connection for torque
- Insulation material are anti-burn with high low temperature resistance
- Test up-to 10000v with GS/VDE certification IEC 60900:2012



PART NO.	Length (inches)
BLPISDADJ10	10



Insulated Ring wrench

Packing: 1

- Tools are VDE certified with certificate
- Made from high impact resistance injection for increased connection for torque
- Insulation material are anti-burn with high low temperature resistance
- Test up-to 10000v with GS/VDE certification IEC 60900:2012



PART NO.	Size (mm)	Length (mm)
BLPISDRW6	6mm	130
BLPISDRW7	7mm	140
BLPISDRW8	8mm	150
BLPISDRW9	9mm	160
BLPISDRW10	10mm	170
BLPISDRW11	11mm	180
BLPISDRW12	12mm	190
BLPISDRW13	13mm	200
BLPISDRW14	14mm	210
BLPISDRW15	15mm	215
BLPISDRW16	16mm	215
BLPISDRW17	17mm	220
BLPISDRW18	18mm	230
BLPISDRW19	19mm	240
BLPISDRW21	21mm	250
BLPISDRW22	22mm	260
BLPISDRW24	24mm	280
BLPISDRW27	27mm	290
BLPISDRW30	30mm	310
BLPISDRW32	32mm	320



Insulated Open End Wrench

Packing: 1

- Tools are VDE certified with certificate
- Made from high impact resistance injection for increased connection for torque
- Insulation material are anti-burn with high low temperature resistance
- Test up-to 10000v with GS/VDE certification IEC 60900:2012



PART NO.	Size (mm)	Length (mm)
BLPISDOE6	6mm	89.5
BLPISDOE7	7mm	89.9
BLPISDOE8	8mm	99.5
BLPISDOE9	9mm	99.2
BLPISDOE10	10mm	110
BLPISDOE11	11mm	120
BLPISDOE12	12mm	130
BLPISDOE13	13mm	140
BLPISDOE14	14mm	150
BLPISDOE15	15mm	160
BLPISDOE16	16mm	165
BLPISDOE17	17mm	165
BLPISDOE18	18mm	175
BLPISDOE19	19mm	180
BLPISDOE21	21mm	195
BLPISDOE22	22mm	205
BLPISDOE24	24mm	230
BLPISDOE27	27mm	249
BLPISDOE30	30mm	284
BLPISDOE32	32mm	308

NEW! Insulated Ratcheting Wrench

Packing: 1

- Tools are VDE certified with certificate
- Made from high impact resistance injection for increased connection for torque
- Insulation material are anti-burn with high low temperature resistance
- Test up-to 10000v with GS/VDE certification IEC 60900:2012



PART NO.	Size (mm)	Length (mm)	PART NO.	Size (mm)	Length (mm)
BLPISDRWR10	10mm	135	BLPISDRWR15	15mm	165
BLPISDRWR11	11mm	140	BLPISDRWR16	16mm	170
BLPISDRWR12	12mm	145	BLPISDRWR17	17mm	180
BLPISDRWR13	13mm	150	BLPISDRWR18	18mm	190
BLPISDRWR14	14mm	160	BLPISDRWR19	19mm	200

NEW! Insulated Hex Key

Packing: 1

- Tools are VDE certified with certificate
- Made from high impact resistance injection for increased connection for torque
- Insulation material are anti-burn with high low temperature resistance
- Test up-to 10000v with GS/VDE certification IEC 60900:2012



PART NO.	Size (mm)	Length (mm)	PART NO.	Size (mm)	Length (mm)
BLPISDH3	3mm	130	BLPISDH8	8mm	200
BLPISDH4	4mm	140	BLPISDH10	10mm	235
BLPISDH5	5mm	160	BLPISDH12	12mm	260
BLPISDH6	6mm	180			

Insulated Long Nose Pliers

Packing: 6

- Chrome vanadium steel
- Tested under 10,000 voltage testing machine
- Specially designed soft grips
- Laser hardened cutting edge



PART NO.	LENGTH (mm)
WT1001-6	160
WT1001-8	200

Insulated Side Cutters

Packing: 6

- Chrome vanadium steel
- Tested under 10,000 voltage testing machine
- Specially designed soft grips
- Laser hardened cutting edge



PART NO.	LENGTH (mm)
WT1003-6	160
WT5403-8	203

Insulated Combination Pliers

Packing: 6

- Chrome vanadium steel
- Tested under 10,000 voltage testing machine
- Specially designed soft grips
- Laser hardened cutting edge

PART NO.	LENGTH (mm)
WT1014-6	160
WT1014-7	180
WT1014-8	200
WT5414-9	225



201 **WARNING** • Plastic coated handle does not protect against electric shock
• Read safety precautions on page 220

Insulated Slip Joint Pliers

WT8627-10

Packing: 6

- Chrome vanadium steel
- Tested under 10,000 voltage testing machine
- Specially designed soft grips
- Laser hardened cutting edge



PART NO.	LENGTH (mm)
WT8627-10	250

Insulated Wire Stripping Pliers

WT1017C-6

Packing: 6

- Chrome vanadium steel
- Tested under 10,000 voltage testing machine
- Specially designed soft grips
- Laser hardened cutting edge



PART NO.	LENGTH (mm)
WT1017C-6	160

Insulated Scissors

- Tools are VDE certified with certificate
- Made from high impact resistance injection for increased connection for torque
- Insulation material are anti-burn with high low temperature resistance
- Test up-to 10000v with GS/VDE certification IEC 60900:2012

PART NO.	Length (mm)
BLPISDSC160	160

Insulated Series, Phillips®

Packing: 10

- Insulated screwdriver for Phillips® PH-head screws, for work on live equipment up to 1000V
- Examination of screwdrivers according to latest national and international standards
- Examination piece-wise in water bath with 10 KV
- Ergonomically developed 2-component handle
- Blade black oxidized, entirely hardened
- Manufactured according to
 - IEC60900 Standard
 - VDE Certified
 - GS Certified



PART NO.	TIP SIZE (#)	A (mm)	L (mm)
BSGD60PH0V	PH0	60	130
BSGD80PH1V	PH1	80	180
BSGD100PH2V	PH2	100	210
BSGD150PH3V	PH3	150	270

Insulated Series, Slotted

Packing: 10

- Insulated screwdriver for slotted screws, for work on live equipment up to 1000V
- Examination of screwdrivers according to latest national and international standards
- Examination piece-wise in water bath with 10 KV
- Ergonomically developed 2-component handle
- Blade black oxidized, entirely hardened
- Manufactured according to
 - IEC60900 Standard
 - VDE Certified
 - GS Certified



PART NO.	TIP SIZE (mm)	A (mm)	L (mm)
BSGD7525V	2.5	75	145
BSGD1004V	4	100	200
BSGD12555V	5.5	125	225
BSGD15065V	6.5	150	260

AUTOMOTIVE WORKSHOP TOOLS

Unsurpassed Heavy-Duty Performance

Blue-Point[®]



Pick Up Tool



Pick Up Tool

PHT5

Packing: 1

- Lifts 2.5 lbs.
- Chrome plated shaft extends from 5 1/2" to 25 1/2"
- Black cushion grip will not slip in oily or wet hands
- Includes pocket clip
- Hinged head magnetic pick up tools
- Powerful magnets are fitted into the brass sleeve
- Adjustable hinged heads



Pick Up Tool

PT5CBL

Packing: 1

- This 5 7/8" tool extends to 25 9/16"
- Magnet lifts up to 2 lbs.
- Includes pocket clip
- Blue
- Hinged head magnetic pick up tools
- Powerful magnets are fitted into the brass sleeve
- Adjustable hinged heads



Pick Up Tool

UPTM5

Packing: 1

- 6 1/2" tool extends to 21 1/4"
- Magnet lifts up to 0.66 lbs.
- Includes pocket clip
- Hinged head magnetic pick up tools
- Powerful magnets are fitted into the brass sleeve



Pick Up Tool

PT5C

Packing: 1

- This 5 7/8" tool extends to 25 9/16"
- Magnet lifts up to 2 lbs.
- Includes pocket clip
- Chrome
- Hinged head magnetic pick up tools
- Powerful magnets are fitted into the brass sleeve
- Adjustable hinged heads



Pick Up Tool

UPT15

Packing: 1

- Lifts 2 lbs.
- 6 5/8" long, and extends to 33 1/4"
- Hinged head magnetic pick up tools
- Powerful magnets are fitted into the brass sleeve
- Adjustable hinged heads



Pick Up Tool

UPT2FL

Packing: 1

- 29" aluminum shaft can be easily bent at any angle to retrieve dropped metal objects in hard to reach areas
- Power cap slides over the magnet and shield its sides from attaching to unwanted metal surfaces
- Will pick up 5 lbs. with the power cap
- Textured cushion pistol grip will not slip in wet or oily hands



Pick Up Tool

UPT50A

Packing: 1

- Lifts 10 lbs.
- 6 5/8" long, and extends to 33 1/4"
- Hinged head magnetic pick up tools
- Powerful magnets are fitted into the brass sleeve
- Adjustable hinged heads



Pick Up Tool

UPT65

Packing: 1

- Perfect for retrieval of heavy ferrous objects in hard to reach areas
- Goblet shaped magnetic head pushes the flux to the front of the magnet enabling the user to lift 16 lbs
- Head shields the sides of the magnet from attaching to unwanted ferrous surfaces
- Telescopes from 9" to 34 1/4" (229 to 870mm)
- Stainless steel handle is strong, lightweight and inhibits corrosion
- Cushion textured pistol grip will not slip in wet or oily hands



Pick Up Tool

UPT35

Packing: 1

- Lifts 4 1/2 lbs.
- 6 5/8" long, and extends to 33 1/4"
- Hinged head magnetic pick up tools
- Powerful magnets are fitted into the brass sleeve
- Adjustable hinged heads



Pick Up Tools Set

BLPIM5KIT

Packing: 1

- Quick release telescope for easy switch between usage
- Super bright white LED
- Include 2 mirrors; rectangular 64x43mm, round 60mm diameter
- Magnet able to lift up to 8 lbs.
- Batteries life of 10-12 hours of normal usage



Box Seat Creeper

BPSCKPCM

Packing: 1

- Size: :L500 x W420 x H360 mm
- 2 drawers with depth of 3.6" provide more storage space for users
- PE Blue paint powder to protect against corrosion and provide durability
- Top and bottom panel thickness of 1.5mm for extra durability
- 3.6" drawer depth for more tools storage
- Each drawer designed to withstand 45kg of tools
- Plywood backing for extra strength
- High density foam for comfort and durability
- 2" ball bearing casters



Oval Tube Creeper

JCW8A

Packing: 1

- 40" long creeper is constructed of 16 ga. steel and has a unique drop in the shoulder area to provide for generous shoulder clearance; low 3/4" ground clearance
- Fully padded with heavy duty foam for durability; pad measures 1 3/4" thick, headrest pad measures 2 3/4" thick covered with heavy duty vinyl
- Four 2 1/2" oil resistant, full ball bearing casters



PART NO.	PAD COLOR	WEIGHT (kg)	OVERALL SIZE (inches)
JCW8A	Black	8.2	L40 x W17 x H4
PAD WIDTH (inches)	PAD LENGTH (inches)	NUMBER OF CASTERS	CASTER DIAMETER (inches)
11	39	4	2 1/2

Welders Gloves

YA427B

Packing: 1

- Helps protect hands from sparks when welding
- Leather construction with added insulation for heat protection
- Reinforced palm for durability



Tig Welding Gloves

YA4282

Packing: 1

- Ideal for TIG welding processes
- Pigskin material for precise control
- Helps protect hands from heat and sparks
- Thick leather cuff for wrist protection



Welding Sleeves 1 Pair

YA4280

Packing: 1

- Helps protect arms from sparks when welding or cutting
- Elastic bands at each end of sleeve
- Constructed of flame retardant fabric
- 18" long
- 1 pair



Washable Work Gloves

Packing: 1

- Gloves feature stretch knit with padded back to provide extra feel and flexibility to grasp small objects
- Extra knuckle protection on back of fingers
- Heat resistant synthetic double layered leather palm for longer life
- Elastic cuff with hook and loop closure



Abrasion Resistant Nitrile Gloves

Packing: 3

- Nitrile dipped coating for protection on dirty jobs
- Ergonomically pre-curved design gives you comfort at all times
- High abrasion resistance protects hand on sharp edges and rough castings
- Incredible grip and dexterity on wet and dry surfaces
- Lightweight nylon shell provides a nice snug fit
- CE rated for abrasion, blade cut, tear and puncture resistance



PART NO.	SIZE	COLOR
GLOVE103MA	Medium	Black
GLOVE103LA	Large	Black
GLOVE103XLA	X-Large	Black
GLOVE103MAB	Medium	Blue
GLOVE103LAB	Large	Blue
GLOVE103XLAB	X-Large	Blue

PART NO.	SIZE
GLOVE400S	Small
GLOVE400M	Medium
GLOVE400L	Large
GLOVE400XL	X-Large
GLOVE400XXL	XX-Large



Safety Glasses

Packing: 1

- Complies with ANST Z87.1-2003
- Lens provide 99.9% UV protection
- Angle and length adjustable temples provide various suitable fitting
- Soft nose pad and soft temple tips provide comfort for long-time wearing
- Anti-fog lens coating with anti-scratch protection
- GLASS30BK and GLASS30R have a ventilation channel between frame and lens



PART NO.	LENS	FRAME
GLASS30R	Clear	Red
GLASS30BK	Clear	Black
GLASS31R	Clear	Red
GLASS31BK	Clear	Black

Ear Protector

GA3200

Packing: 1

- Noise reduction rating of 28 dB for protection
- Lightweight and comfortable with cushioned headband
- Cushioned ear piece pivots to provide for a comfortable and snug fit that keeps out noise
- Blue hard protective ear cups with Blue-Point® logo in white
- Each ear piece easily adjusts to fit a variety of sizes



PART NO.	NOISE REDUCTION Rating, dB	HEADBAND
GA3200	28	Cushioned
EAR PIECE	ADJUSTABLE EAR PIECE	WEIGHT (lbs.)
Cushioned	Plastic	0.77

Face Shield

GA225

Packing: 1

- Adjustable, cushioned head band is removable
- Face shield provides impact resistance
- Includes shield (GA225-1) with PETG (impact resistance preferred)
- Optional shield (GA225-2) with PC (high temperature resistance) is available



PART NO.	SHIELD STYLE	SHIELD SIZE (inches)	HEADBAND
GA225	Flat	7 3/4 x 15 1/4	Yes
ADJUSTABLE HEADBAND	IMPACT RESISTANCE	SHIELD INCLUDED	REPLACEMENT SHIELDS
Yes	Yes	Clear	GA225-1 (with PETG) GA225-2 (with PC)

Ear Protector, Ear Plug Style

YA160A

Packing: 1

- 25 dB noise reduction rating
- Cushioned ear piece for comfort and snug fit to keep out noise
- Non-conductive
- Includes extra set of foam ear piece and reusable storage bag

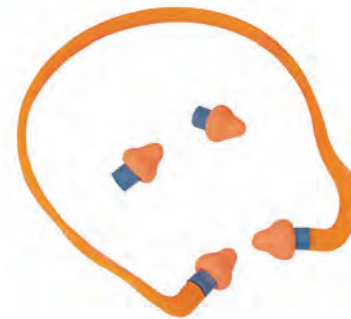

PART NO.	NOISE REDUCTION Rating, dB	HEADBAND	
YA160A	25	Plastic	
EAR PIECE	ADJUSTABLE EAR PIECE	EAR PIECE REPLACEMENTS	WEIGHT (lbs.)
Foam	Foam	YA160A1	0.06

Welding Helmet, Auto Darkening

YA4603

Packing: 1

- Fixed shade auto darkening welding helmet has a lens that is designed for carbon arc welding processes. Two arc sensors provide a range of sensitivity to trigger the lens under most welding conditions.
- Fix delay
- Meets ANSI Z87.1-2003, CE, DIN 4647 PZ, EN379, EN175, CSA Z 94.3 and AS/NZS 1338.1 standards



PART NO.	# OF SENSORS	SHADE	CLEAR SHADE	VIEWING AREA (inches)	POWER
YA4603	2	#10	#3	3.81 x 1.38	Solar

Fender Cover

BLPFEN1B

Packing: 1

- Dimension: 1070 x 400 mm
- Upper layer material: PVC synthetic leather
- Underlay material: Brushed fabrics
- 8 pcs magnet for secure hold onto vehicle
- Color: Blue with white Blue-Point logo printing
- Applications: Use in automotive maintenance and repair work



Floor Jack, 2 Ton Low Profile

BLPHJ2TSAP

Packing: 1

- 2 ton heavy duty service Jack
- Super-tough precision welded construction
- Exclusive dual parallel pump design provides user with speed in work
- Side plates are flanged for additional strength
- Safety release valve feature to prevent damage to jacks if vehicle exceeds capacity
- Wide steel caster design provides stability during movement
- Low profile for easy access under vehicle



PART NO.	CAPACITY (tons)	MIN. HEIGHT (mm)	MAX. HEIGHT (mm)	DIMENSION L X W X H (mm)	NET WEIGHT (kg)
BLPHJ2TSAP	2	75	500	685 x 344 x 150	34

UV Leak Detection Flashlight Kit

ECFUVLITE

Packing: 1

- High intensity LED bulb with 100,000 hour service life
- Over four hours of peak performance per charge
- Power comparable to high intensity 75 watt lamps
- Compatible with all standard leak detection dyes
- Inspection range of up to 6'
- Includes (3) "AAA" batteries and fluorescence enhancing glasses



Wheel Dolly

YA15WDAP

Packing: 1

- Rugged steel construction with hydraulic foot pedal lift for hands-free use
- Lifts wheel weight to 1500 lbs, combined vehicle weight of 6,000 lbs
- Open-side lift handles tires up to 32" diameter x 9" wide
- Heavy duty 4" non-marring swivel casters



Floor Jack, 2.5 Ton / 3.5 Ton

BLPHJ25TSAP

Packing: 1

- 2.5 ton and 3.5 ton heavy duty service Jack
- Super-tough precision welded construction
- Exclusive dual parallel pump design provides user with speed in work
- Side plates are flanged for additional strength
- Safety release valve feature to prevent damage to jacks if vehicle exceeds capacity
- Wide steel caster design provides stability during movement



PART NO.	CAPACITY (tons)	MIN. HEIGHT (mm)	MAX. HEIGHT (mm)	DIMENSION L X W X H (mm)	NET WEIGHT (kg)
BLPHJ25TSAP	2.5	120	460	628 x 343 x 158	34
BLPHJ35TSAP	3.5	110	520	732 x 364 x 170	48





3 Ton Floor Jack

YF3PH

Packing: 1

- 3 Ton capacity
- Soft rollers for smoother and silent operation
- Smooth lift of the vehicle



PART NO.	CAPACITY (tons)	MIN. HEIGHT (mm)	MAX. HEIGHT (inches)	SADDLE SIZE (mm)	FRAME LENGTH (mm)	HANDLE LENGTH (mm)
YF3PH	3	130	462	119	617	1,243

3 1/2 Ton Floor Jack

YA1707

Packing: 1

- Fast acting pump reaches lifting height in less than a pump to allow user to reach a variety of service height situations quickly
- One piece handle for professional users features a foam pad to limit damage to vehicles
- Universal joint release mechanism for smooth action
- Rolled side frames with generous flanges to resist flexing
- Low profile design allows for easy access under vehicles
- Floor Jack used to lift cars and light trucks
- Meets ANSI-PALD standards



PART NO.	CAPACITY (tons)	MAX LIFT HEIGHT (inches)	LOW HEIGHT (inches)
YA1707	3 1/2	22	3 3/4

SADDLE SIZE (inches)	FRAME LENGTH (inches)	HANDLE LENGTH (inches)	WEIGHT (lbs)
4 1/4	29 7/8	50	103

Motorcycle Floor Jack

YA1715

Packing: 1

- 1,500 pound capacity
- Low height of 4 1/2", maximum height of 14 3/4"
- Wide base for extra stability
- Double rubber lined pad provides extra protection to motorcycle while on the jack
- Pull handle assists user to maneuver jack into position
- One foot operation for ease of use
- Safety straps to secure motorcycle to jack
- Self locking safety feature and overload safety valve



1/2 Ton Trans Jack

YA714D

Packing: 1

- Crank for precise and easy alignment
- Four adjustment load support arms fit most transmission pan flanges
- Adjustable to 0.030 inches or less
- Foot pedal pump permits hands free operation
- Wide base and four casters for stability



PART NO.	CAPACITY (tons)	MAX. HEIGHT (inches)	SADDLE BASE (inches)
YA714D	1/2	69 7/8	8 7/8 x 7 1/8
LIFTING HEAD SIZE (inches)	HANDLE LENGTH (inches)	CHASSIS WIDTH (inches)	TILT
15 1/2 x 15 1/2	11	33 1/2	12°
MINIMUM HEIGHT (inches)	EXP. SADDLE AREA (inches)	JACK SIZE (inches)	NET WEIGHT, (kg)
33	21 x 21	L 34 1/8 x W 36 1/8	82.2

4 Ton Portaset

YA1544A

Packing: 1

- 4-ton capacity kit includes hydraulic unit, five "Snap-Set" extensions, spreader plus a full selection of attachments for most push applications
- Automatic pump overload system protects against damage to rams and equipment
- 1/2-ton capacity hydraulic spreader has 2" jaw and spreads from 5/8" to 3 3/4"
- Flex head includes permanently molded rubber pad
- Heavy walled extensions tubes stand up to the toughest loads
- Long handle reduces required pumping effort
- 18 piece set is stored in durable storage case



12 Ton Jack Stands

YA512

Packing: 1

- Counter-weighted pawl serves as a secure locking device to prevent the load from accidentally disengaging
- Sturdy, welded steel construction for superior strength
- One piece, multi-position ductile ratchet bar provides super strength, durability and quick adjustment mechanism that securely locks into desired location



PART NO.	CAPACITY (tons)	LOW HEIGHT (inches)	MAXIMUM HEIGHT (inches)
YA512	12 (per pair)	17 1/2	27 1/2

8 Ton Bottle Jack

YA1228

Packing: 1

- Hydraulic system is protected from internal damage by a patented by-pass mechanism
- Machined and polished cylinders with die-cut threading provide non-abrasive leak-free, durable performance
- Fabricated from hard-cast steel



PART NO.	CAPACITY (tons)	LOW HEIGHT (inches)	MAX. HEIGHT (inches)	SCREW EXTENSION (inches)
YA1228	8	8 1/8	17 5/8	2 3/4
BASE SIZE (inches)	OPERATING FORCE (lbs.)	CAP DIAMETER (inches)	HANDLE LENGTH (inches)	
4 3/4 x 4 3/4	101	1 3/8	18 1/8 (assembled)	

Bottle Jacks

Packing: 1

- Improved design with welded joints to prevent seal leakage



PART NO.	CAPACITY (tons)	MIN. HEIGHT (inches)	MAX. HEIGHT (inches)	ADJUST HEIGHT (inches)
YB2AP	2	6 3/4	14 5/8	4 2/5
YB3AP	3	6 3/4	14 5/8	4 2/5
YB5AP	5	8 1/3	18 2/5	5 3/4
PART NO.	BASE (inches)	HANDLE (inches)	CAP DIAMETER (inches)	OPERATING FORCE (lbs)
YB2AP	4 x 4 1/10	16 1/2	1 1/10	45
YB3AP	4 x 4 1/10	16 1/2	1 1/10	78.75
YB5AP	4 1/3 x 4 2/5	16 1/2	1 1/4	90

Engine Crane

YA12AP

Packing: 1



PART NO.	CAPACITY	MIN. HEIGHT (mm)	MAX. HEIGHT (mm)	DIMENSION (mm)	CERTIFICATE	NET WEIGHT (kg)	GROSS WEIGHT (kg)	PACKAGING (mm)
YA12AP	2 Ton	340	1,797	1,830 x 760 x 1,550	2005 ASME /PALD	109	114	#1 - 810 x 570 x 90 #2 - 1,695 x 195 x 85 #3 - 1,295 x 315 x 170

Heavy Duty Workbench

BPWORKBENCH

Packing: 1

- Features a full bottom shelf and superior powder coat finish
- Dimensions: 60.08" x 30.73" x 34.08"
- Net Weight: 138.9 lbs. (63.06 kg)
- Weight Capacity: 1,200 lbs.
- Top panel: 2.0mm thickness
- Bottom shelf: 2.0mm thickness
- Steel support: 2.5mm thickness



Tweezer Kit, 5pcs

TZK5

Packing: 1

- Vinyl zipper pouch packaging
- All stainless construction



PART NO.	CONTENTS	LENGTH (inches)
TZK5	Pointed tweezers with plain ends	4 3/8
	Self-closing tweezers with plain ends	4 1/2
	Self-closing, weighted solder tweezers with serrated blunt end	7
	Sharp point utility tweezers with bent plain ends	7
	Sharp point utility tweezers with plain ends	7

Pick Sets

Packing: 1

- Heavy duty shank diameter is 0.02" thicker than standard picks for added durability and extended tool life



PART NO.	DESCRIPTION	LENGTH (inches)
PSLR4-1	Hook Pick	9 3/4
PSLR4-2	90° Hook Pick	9 3/4
PSLR4-3	Straight Pick	9 3/4
PSLR4-4	Complex Pick	9 3/4
PSLR4-5	Combo Pick	9 3/4
PSLR4-6	Double Angle Pick	9 3/4
PSLR6	Extra Long Pick Set, 6pcs PSLR4-1, PSLR4-2, PSLR4-3, PSLR4-4, PSLR4-5, PSLR4-6 in vinyl storage pouch	
PSLR4	Extra Long Pick Set, 4pcs PSLR4-1, PSLR4-2, PSLR4-3, PSLR4-4, in vinyl storage pouch	

Tweezer Kit, 7pcs

TZK7

Packing: 1

- Black vinyl zipper pouch packaging
- All stainless construction



PART NO.	CONTENTS	LENGTH (inches)
TZK7	Pointed tweezers	4 3/8
	Curved head utility tweezers	6 3/4
	Self-closing, heat-resistant tweezers	6
	Sharp pointed utility tweezers	7
	Side locking tweezers	6
	Spade point tweezers	4 3/8
	Weighted solder tweezers	6

Cable Cutter

PWC80A

Packing: 1

- For cutting battery cables and other soft metal cables
- Has vinyl covered handles
- 7 1/2" long



Leverage Hose Cutter

PWC60

Packing: 1

- (8 1/2") Compound action multiplies normal hand pressure to easily slice through many types of rubber and plastic hose up to 1 1/8" in diameter
- Includes stainless steel cutter blades and internal components



Wire Stripper, Automatic

PWC27

Packing: 1

- One-step stripping enhances productivity
- Spring-action motion increases leverage and reduces operator fatigue
- Precision ground, knife-type blades provide clean, accurate stripping
- Cleanly strips wire up to full 7/8" (22mm)

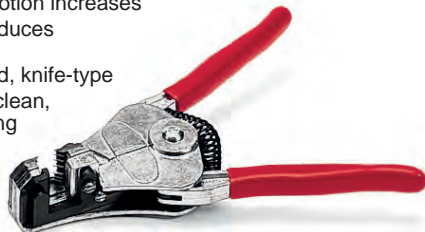

Wire Cutter, Micro Shear

PWC19

Packing: 1



PART NO.	LENGTH (inches)	STRIPS AWG SIZES	APPLICATION	REPLACEMENT BLADES
PWC27	6 1/4	10, 12, 14, 16, 18, 20, 22	Strips PVC, THHN and THWN	PWC27-7

PART NO.	LENGTH (inches)	STRIPS AWG SIZES	STRIPS METRIC SIZES (mm)
PWC19	5 1/8	Up to 20	Up to .80

Wire Stripper

PWC6

Packing: 1



Wire Stripper

PWC28A

Packing: 1



PART NO.	DESCRIPTION	LENGTH (inches)
PWC6	Wire Stripper /Cutter Pliers	6

STRIPS AWG SIZES	STRIPS METRIC SIZES (mm)	APPLICATION
10, 12, 14, 16, 18, 20	2.6, 2.0, 1.6, 1.3, 1.0, 0.80	Strips PVC, THHN, and THWN

PART NO.	DESCRIPTION	LENGTH (inches)
PWC28A	Wire Stripper /Cutter / Crimper /Bolt Cutter	8 1/4

STRIPS AWG SIZES	STRIPS METRIC SIZES (mm)
10, 12, 14, 16, 18, 20, 22 Stranded, 8, 10, 12, 14, 16,18 Solid	10 - 22 Non-Insulated Terminals and Crimp Sleeves

Wire Stripper

PWC14

Packing: 1



PART NO.	DESCRIPTION	LENGTH (inches)
PWC14	Wire Stripper /Cutter / Crimper /Bolt Cutter	8 3/4
STRIPS AWG SIZES		STRIPS METRIC SIZES (mm)
10, 12, 14, 16, 18, 20, 22		10 - 22mm Insulated and Non-Insulated 7 - 8mm Ignition Terminals

Wire Stripper

PWC12A

Packing: 1



PART NO.	DESCRIPTION	LENGTH (inches)
PWC12A	Wire Stripper /Cutter / Crimper	9 1/2
STRIPS AWG SIZES		STRIPS METRIC SIZES (mm)
10, 12, 14, 16, 18		10 - 18mm Insulated and Non-Insulated 7 - 8mm Ignition Terminals

Crimp Tool

PWC34

Packing: 1

- Double compound action with ratchet control for almost effortless operation
- Use with insulated connectors on 10 to 22 gauge wire
- For easy, efficient, single squeeze crimping of modular connectors
- Both primary and secondary crimps are made simultaneously to factory specifications
- Has a comfortable ergonomic design and full cycle ratchet action



Boot Pliers

YA824C

Packing: 1

- 45° offset jaws
- Vinyl coated jaws and handles assure gripping ability
- Use only on automotive type ignition systems
- 9 1/2" long



Exhaust Hanger Removal Pliers

YA3202

Packing: 1

- For removing hanger brackets from their rubber mounting straps
- Place removal jaw behind the rubber grommet ring and the forcing pin of the pliers on the end of the steel hanger
- When handles are squeezed, the forcing pin pushes the ring off the hanger
- Applications on most domestic and import cars as well as light trucks
- 14" long



Boot Pliers

YA824ASTR

Packing: 1

- Straight jaw version of YA824C
- 9 3/4" long



Oil Filter Pliers, Adjustable

YA4274

Packing: 1

- Use on filters from 2 1/2" to 5 1/4" diameters
- Use on automotive and truck applications
- Spring action size adjustment assures a solid grip on filter
- Offset handle offers increased accessibility
- Heavy duty forged levers
- Cushioned grips for comfort
- Industrial black finish with blue grips
- Overall length of 13 1/2"

**Oil Filter Pliers, Extra Large**

YA4275

Packing: 1

- Use on filters from 4 1/4" to 7" (108-178mm) diameters
- Applications include truck, tractor and high torque diesel engines
- Spring action size adjustment assures a solid grip on filter
- Offset handle offers increased accessibility
- Heavy duty forged levers
- Cushioned grips for comfort
- Industrial black finish with blue grips
- Overall length of 19"

**Seal Pliers**

YA8230

Packing: 1

- Removes valve stem seals from overhead camshaft engines including 4 valve per cylinder engines that have restricted access to the valve stem seal due to the head design
- Gripping serrations in the pliers tip easily grab both OEM and aftermarket seals with ease
- Easy grip handles

**Windshield Removal Tool**

YA109C

Packing: 1

- Steel cable pull handle
- Replaceable steel cutting blades can be resharpened
- For GM, Chrysler, and other cars with windshields set in place with sealant

**Magnetic Tool Holder**

MAGWRENCH

Packing: 1

- Industrial strength magnets keep it secured to a metal surface
- Holds tools for quick and easy access
- Chrome plated steel bar with chrome plated nylon ends
- Overall size is 20" (with approximately 12" of magnetic holding space)





Multi-Tool Set, 4pcs

BLP4GIFT

Packing: 1

- Small and Medium 12-in-1 multi tool
 - Corrosion resistant steel blade
 - Pliers fold for safety and compact storage
 - Aluminum housing with durable anodized finish
- Folding pocket knife
 - 2.5" blade length
 - 85 grams
- LED mini multi tool keychain
 - 5 different functions (Slotted & Philips screwdriver, knife, bottle opener, flashlight)



Oil Drainer

YB900D

Packing: 1

- High Capacity 70 litres reservoir tank with a 18 litres collecting bowl
- Indicator to display oil level and air tank pressure
- Includes Plastic tray for holding tools, parts and consumables



Wire Brushes

- Stainless steel bristles
- General-purpose cleaning, rust removal, deburring, edge blending, and roughing for adhesion.
- Perfect for cleaning debris in tight spots

Packing: 1

PART NO.	LENGTH (Inches)
AC5CAP	7 7/8
AC59CAP	13 3/4



AC5CAP



AC59CAP



Flexible Spring Claw Set, 2pcs

BLPFSCS

Packing: 1

- Polybag packaging
- Cold roll steel with nickel plating handle
- Spring steel claw
- 4 claws hold up to 2 lbs



PART NO.	CONTENTS	LENGTH (mm)
BLPFSCS	BLPFSC240 Flexible Spring Claw	340
	BLPFSC600 Flexible Spring Claw	600

Door & Trim Panel Tool Set, 5pcs

BLPDTPS5

Packing: 1

- Automotive trim and molding tool set
- Everything needed for specialized automotive repairs
- Easy removal of trim, molding, door panels and dashboards
- Works on interior and exterior trim



Door Lockout Set

LOS145A

Packing: 1

- No danger of airbag activation or disconnected door linkages
- Actuate the door handle, manual lock button or electric lock button on most cars and trucks
- Includes:
 - 4 pcs door-unlocking tool that screws together without couplers for easy assembly and storage, plastic slim jim, 2 glow-in-the-dark tips, 2 plastic wedges to create gap between door and frame without damaging door or weather stripping and BF272 inflatable wedge
- Use the BF272 to easily separate door from body without damage to the vehicle
- Unlocking tool features a middle extension piece to reach across the car in extended use applications
- For sale to registered locksmiths, police and bona fide repair professionals only



Air Riveter

HP301C

Packing: 1

- Sets structural rivets, KLIK-FAST® rivets from 5/32" to 1/4" diameter in all alloys plus KLIK-SPLIT® / Monobolt rivets from 3/16" to 1/4"
- Includes 5/32", 3/16" and 1/4" nosepieces plus mandrel collection bottle

PART NO.	RECOMMENDED AIR PRESSURE (psi)
HP301C	85-95
AIR INLET THREAD SIZE	TRACTION POWER (lbs)
1/2" NPT	3,300
STROKE	WEIGHT (kg)
5/8" (15.8 mm)	3.0



Pivot Riveter

RHR-2

Packing: 1

- 360° swivel head for easy riveting in narrow and awkward places at any angle
- Positive-Lock Rotation for turning and holding swivel head in positive lock position to avoid undesired rotation that may result in poor riveting job
- Superior materials, high strength aluminum head and body
- Heavy duty steel handle, hardened steel parts
- Durable powder coating with polished logos
- Ratchet sound for alerting desired or unexpected rotation of swivel head



Industrial Hand Riveter

HR-26

Packing: 1

- Forged Cr-Mo steel alloy upper handle
- Anti-wear design with high strength aluminum body and steel insert
- Special shock absorber on body
- Auto-ejection design allows quick replacement of inside worn parts such as jaws, by removing retaining screw
- Long leverage and power saving design; extra long handles 260mm for better leverage to save hand force



Rivet Tool

HP2

Packing: 1

- Has four nose pieces for 3/32" to 3/16" diameter rivets
- For 1/8" thru 5/8" thickness
- Made of aluminum alloy



Extractor Set

E1025

Packing: 1

- Extract broken screws from 1/4" to 1" diameter and standard pipe sizes 1/8" to 1"
- Storage case packaging



Thread Setter Kits

HP650 / HP650M

Packing: 1

- HP650
- Includes: rugged thread setter tool and an assortment of fractional
 - Klik Poly-Nuts: 12 each 8-32, 10-24, 10-32; (8) 1/4"-20 and (6) 5/16"-18 threads
 - Includes required nosepieces and mandrels for setting the above sizes
 - Packaged in a storage case

- HP650M
- Metric version of the HP650 with metric poly-nuts, including 25 each 4 and 5mm, (15) 6mm and (10) 8mm threads
 - Includes thread setter tool, required nosepieces and mandrels packaged in a storage case



Extractor Set

E1020

Packing: 1

- Extracts broken screws from 1/4" to 1/2" diameter
- Storage case packaging



Grease Gun, Air

YA772B

Packing: 1

- Automatic operation provides continuous grease flow with trigger depressed
- Pumps at a 40:1 ratio with a maximum pressure of 6,000 PSI
- Use with standard 14 oz. cartridge, bulk fill or filler tube
- Heavy duty 18" flexible nylon hose improves accessibility and reach
- Air vent allows easy removal of trapped air after loading grease tube
- Light weight of 3.52 lbs
- Helps reduce operator fatigue



PART NO.	PSI	Air Operating (psi)	Pump Ratio
YA772B	4,000	60 - 150	40:1
Capacity	Flexible Hose (inches)	Rigid Extension (inches)	Loading
14 oz. Cartridge	18	6	Bulk, Filler Pump, or Cartridge

Grease Gun, Lever

YA728A

Packing: 1

- Lever operated, large capacity gun accepts 16 oz. bulk or 14 1/4 oz. cartridge grease
- Develops 6,000 PSI
- Includes tough, 18" flexible whip hose with coupler and 6" rigid extension



PART NO.	PSI	CAPACITY
YA728A	6,000	16 oz. Bulk and 14 1/4 oz. Cartridge
FLEXIBLE HOSE (inches)	RIGID EXTENSION (inches)	LOADING
18	6	Bulk or Cartridge

Grease Gun, Pistol Grip

GA472

Packing: 1

- Standard series grease guns
- All are steel with zinc plating
- Inner-spring chamber can be either cartridge or bulk loaded



PART NO.	PSI	NOZZLE (inches)
GA472	5,000	13 1/4
CAPACITY (oz.)	RIGID EXTENSION (inches)	LOADING
14	3 1/2	Bulk, Cartridge, or Filler Pump

Grease Gun, Pistol Grip

YA734A

Packing: 1

- Develops 6,000 PSI maximum pressure
- Pistol grip unit features suction, cartridge, or filler pump loading
- Includes flip over follower, 18" flexible hose, 6" rigid extension and hydraulic coupler



PART NO.	PSI	CAPACITY
YA734A	6,000	16 oz. Bulk and 14 1/2 oz. Cartridge
FLEXIBLE HOSE (inches)	RIGID EXTENSION (inches)	LOADING
18	6	Bulk or Cartridge

Oil Suction Gun

YA745A

Packing: 1

- 16 oz. capacity
- Fast, clean method for removing or adding transmission and gear oil
- Special follower is impervious to oil, grease, and water
- Flexible nozzle



1.4 HVLP Spray Gun

BLPK14HVLP

Packing: 1

- Lightweight and comfortable for all kinds of painting jobs
- Provides superior spray performance
- Stainless steel needle and tip



PART NO.	FLUID TIP (mm)	AIR CONSUMPTION (scfm)	AIR INLET THREAD SIZE
BLPK14HVLP	1.4	14.5	1/4" NPSM
FLUID (WATER) DELIVERY (mL/min)		AIR PRESSURE RANGE (psi)	CUP SIZE (cc)
190 to 250		30 to 43	600

HVLP Spray Gun

Packing: 1

- Designed for the automotive refinishing painter, Blue-Point® spray guns are lightweight and feature great balance while delivering a quality, first class automotive finish
- A new generation of Blue-Point® spray guns for primer, base and clear coat
- Lowest trigger pull among guns in their class
- Unmatched spray pattern size and quality repair kits
- Optional interchangeable 125cc, 250cc and 600cc aluminum cups are available
- Optional 3M PPS adaptor is also available



PART NO.	FLUID TIP (mm)	AIR CONSUMPTION (scf m)	MAX. INLET HVLP (psi (bar, kpa))	DRY WEIGHT WITHOUT CUP (oz (grams))	AIR INLET THREAD SIZE	CUP SIZE (cc)	APPLICATION
BLP13HVLP	1.3	9.5	29 (2.0, 200)	12.6 (359)	1/4" NPSM	600	High solids, colors and clears
BLP14HVLP	1.4	9.5	29 (2.0, 200)	12.6 (359)	1/4" NPSM	600	High solids, colors and clears
BLP15HVLP	1.5	9.5	29 (2.0, 200)	12.6 (359)	1/4" NPSM	600	Medium solids, colors and clears
BLP18HVLP	1.8	9.5	29 (2.0, 200)	12.6 (359)	1/4" NPSM	600	Primer, high viscosity materials



1.0 Mini HVLP Spray Gun

BLP10MHVLP

Packing: 1



PART NO.	FLUID TIP (mm)	AIR CONSUMPTION (scfm)	AIR INLET THREAD SIZE
BLP10MHVLP	1.0	7.0	1/4" NPSM
MAX. INLET HVLP psi (bar, kPa)	DRY WEIGHT WITHOUT CUP oz (grams)	CUP SIZE (cc)	APPLICATION
29 (20, 200)	11.4 (322)	125	Primer, base and clear

1.4 Conventional Spray Gun

BLP14CONV

Packing: 1



PART NO.	FLUID TIP (mm)	AIR CONSUMPTION (scfm)	AIR INLET THREAD SIZE
BLP14CONV	1.4	9.5	1/4" NPSM
DRY WEIGHT WITHOUT CUP oz. (grams)	CUP SIZE (cc)	APPLICATION	
12.6 (359)	600	All automotive colors and clears	

Bench Vise

Packing: 1

- Single piece steel blocks for higher load capacity
- Extended anvil
- Lubrication points for maintenance
- Optional swivel base
- Capacity range from 3.5 ton to 9 ton at maximum opening
- Reinforced cantilever support
- Interchangeable jaws
- Diamond ground for better grip
- Heavy duty cast iron construction
- Precise jaw alignment
- Rolled thread spindle for easy locating and tightening parts
- Protected spindle



PART NO.	JAW WIDTH
BLPMV4	4" jaws
BLPMV5	5" jaws
BLPMV6	6" jaws

Bench Vise

Packing: 1

- Heavy duty, used for a variety of shop application
- Medium carbon steel serrated jaws, replaceable
- Built-in pipe handle with chrome finish
- Swivel base and large anvil to handle a variety of jobs
- Available in 4 sizes: 4", 5", 6" and 8"



PART NO.	JAW WIDTH (inches)
BLPM4A	4
BLPM5A	5
BLPM6A	6
BLPM8A	8

Pinch Bars

Packing: 1

- Pinch bars are used to align, adjust and move metal and wood
- Angled chisel end for extra leverage when prying



PART NO.	SQ. STOCK (inches)	EDGE (inches)	LENGTH (inches)
1412A	1/2	5/8	14
1658C	1/2	5/8	16
2420A	3/4	15/16	20
2430C	3/4	5/8	30
2438C	3/4	7/8	38
2842C	7/8	1	42

41.5" Curved Fiberglass Prybar

PBFG415

Packing: 1

- Drop forged, hardened steel wedge end with rust-resistant black finish, is chemically bonded to fiberglass handle
- 50,000 strands of fiberglass are sleeved by a polypropylene jacket for comfort and variable hand placement during use
- About one-half the weight of a steel prybar of the same length and less flexible than a steel prybar for greater leverage
- Polypropylene sleeve is resistant to heat and cold for greater comfort in all temperatures

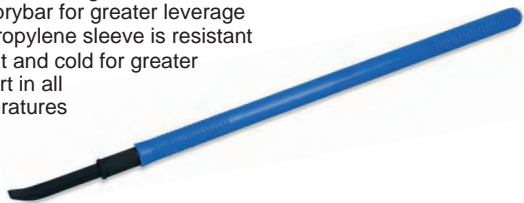

C-Clamps

Packing: 1

- Similar to CL series c-clamps
- High visibility models conform to OSHA safety color standard for physical hazards regulation #19110.144
- 3/4" spindle diameter



PART NO.	CAPACITY (inches)	THROAT DEPTH (inches)
CL404VIS	0 - 4 1/2	3 1/4
CL406VIS	0 - 6 1/16	3 5/8
CL408VIS	0 - 8 1/4	5

Prybar Set

BLPPB704

Packing: 1

- All bars have a 100% black oxide finish



PART NO.	CONTENTS	LENGTH (inches)
BLPPB704	1412A Pinch Bar	14
	2420A Pinch Bar	20
	7031A Close Quarter Bar	16
	BPPC1878 Flat Chisel	18

C-Clamp Compressor

CF19B

Packing: 1

- This compact model includes CF19-3A Jaws for 1/4" to 1 1/16" diameter springs on small, air cooled engines and CF19A5 Jaws for both 17mm and 20.8mm diameter springs on Honda engines



C-Clamp Compressor

CF811B

Packing: 1

- 1" to 2" capacity
- For "L" head, valve-in-head, high compression engines and vehicles with overhead valves
- Activating mechanism prevents cocking of valve spring as it is compressed



Standard Duty Welding Kit

WE200A

Packing: 1

- Use for auto repair, construction, fabrication, manufacturing and maintenance
- Cuts up to 1" and welds up to 1/8"
- Cuts up to 4" and welds up to 1/2" with optional tips
- Durable and strong forged brass regulator
- Regulator diameter 2 1/4" allows precise control of gas
- Internal filter keeps particles from entering regulator
- PTFE Teon seat ensures positive sealing
- Handle shut-o valve color coding provide ease in identifying the corresponding gas control
- Two piece cutting tip allow easy cleaning
- High quality hose offers reduced tear resistance and increased exibility



PART NO.	DESCRIPTION
HRC1401340	85 Weld Handle with Check Valves
HRC1300380	72-3 Cut Attach
HRC9100614	D-85 Weld Mixer
HRC4300557	3/16 x 20 Twin Hose
HRC4304482	Cover Goggle
HRC9004486	Striker
WE200A1	Oxygen Regulator
WE200A2	Acetylene Regulator
HRC1502172	6290-1 #1 AC Cut Tip
HRC1600890	23-A-90-5 #5 Weld Tip
HRC1600870	23-A-90-3 #3 Weld Tip
HRC1600850	23-A-90-1 #1 Weld Tip

Optional Accessories

PART NO.	DESCRIPTION
HRC1800710	J-63-1 Heating Assembly
HRC1600840	23-A-90-0 #0 Weld Tip
HRC1600860	23-A-90-2 #2 Weld Tip
HRC1600880	23-A-90-4 #4 Weld Tip
HRC1502170	6290-00AC #00AC Cut Tip
HRC1502171	6290-0AC #0AC Cut Tip
HRC1502173	6290-2AC #2AC Cut Tip
HRC1502174	6290-3AC #3AC Cut Tip
HRC4301650	88-5FBT PR. Torch Flash Arrestor
HRC9000160	E-9 Tip Cleaner (2 pc tip)
HRC9004484	Replacement Flints

Welder & Plasma Cutter Cart

MIGCARTA

Packing: 1

- Features two trays along with 20" (L) x 12.75" (W) top tray to hold MIG welders and plasma cutters
- Includes cylinder bracket with adjustable chain to hold multiple diameter gas bottles
- Handle has storage tray for smaller items

PART NO.	OVERALL DIMENSIONS (inches)	SHIPPING WEIGHT (lbs.)
MIGCARTA	L41 x W19 1/2 x H25	43



Tap & Die Set

GA541

Packing: 1

- Taps and dies from 1/4" to 1/2" in both NF and NC threads, taps and dies from 4-40 thru 12-24 and corresponding dies in Machine Screw Threads, a pipe thread tap and die, plus two die stocks and three tap wrenches, a screw pitch gauge, and a die adjusting screwdriver (41 pcs) in a storage case
- Die size 1/4" to 1/2" and 7 mm to 12 mm are a one-piece, 12-point design that can be turned with a 1" socket wrench (5/8" socket wrench for 3 to 6 mm dies) when working in places where a normal die stock cannot be used



Metric Tap & Die Set

GAM541

Packing: 1

- 40-pc set features 1" single hex non-adjustable dies from 3 to 12mm, a 1/8" - 28 BSP die plus taps in the same sizes
- Also includes a die stock, 2 T-handle tap wrenches, a thread pitch gauge, a drill/tap chart and a midjet screwdriver, all in a storage case



Bender, Tubing

TBS200A

Packing: 1

- Makes left, right, or offset bends up to a 90° angle
- Degrees shown for accurate bending angle
- Handles 3/16", 1/4", 5/16", and 3/8" (4, 6, and 8mm) OD aluminum, copper, and stainless steel tubing
- Aluminum unit is 8 1/4" long when opened



Deburring Tool

DEBUR300

Packing: 1

- Easily deburr drilled and machined holes
- Push button locking collet enables quick, easy blade changes
- Includes three round head deburring blades
- Blades conveniently store in handle of tool
- Weighs 1 lb
- 6" long



Manifold Set

ACTR4131A

Packing: 1

- Anti-flutter gauges smooth out needle movement
- Easy grip all metal side mounted knobs
- Piston type free floating valves reduce O-ring wear
- Manual R134a couplers
- Gauges can be recalibrated to maintain accuracy
- 60" inner nylon layer hoses meet EPA, SAE, and UL standards
- Yellow hose includes shut off valve

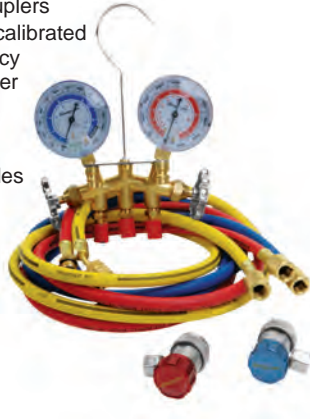

Manifold Repair Kit

ACT1234PKT

Packing: 1

- Includes various replacement lens, knobs, O-rings, gaskets and more
- Kit components are used to service ACTR41511



Replacement Hose (R12)

ACTB72A / ACTY72A

Packing: 1

ACTB72A

- Automatic shutoff valves
- Blue, 6' length

ACTY72A

- Automatic shutoff valves
- Yellow, 6' length



Replacement Hose (R12)

ACTB72 / ACTY72

Packing: 1

ACTB72

- 1/4 turn manual shutoff valves
- Blue, 6' length

ACTY72

- 1/4 turn manual shutoff valves
- Yellow, 6' length



Replacement Hose (R134a)

ACTRB72 / ACTRR72 / ACTRY72

Packing: 1

- Low permeation hoses for internal equipment connections

ACTRB72

- Blue, 6' length

ACTRR72

- Red, 6' length

ACTRY72

- Yellow, 6' length



Replacement Hose (R134a)

ACTRB96 / ACTRR96 / ACTRY96

Packing: 1

- Low permeation hoses for internal equipment connections

ACTRB96

- Blue, 8' length

ACTRR96

- Red, 8' length

ACTRY96

- Yellow, 8' length



Double Flaring Tool Sets

Packing: 1

TF5A Imperial Double Flaring Tool Set

- Makes double or single flares on soft steel, brass, or aluminum tubing from 3/16" to 1/2" OD
- Makes a smooth fitting, crack free 45° flare
- Set includes five adaptors, yoke assembly, bar assembly, and handle
- Storage case included

TFM5A Metric Double Flaring Tool Set

- Same design as TF5A except it is for tubing with an OD from 4.75 to 10mm
- Set includes yoke, bar assembly, handle, and five adaptors: 4.75, 5, 6, 8, and 10mm
- Storage case included



Flaring and Swaging Set

TF275A

Packing: 1

- 45° flare or swage soft copper, brass, or aluminum tubing
- Die blocks handle 1/8", 3/16", 1/4", 5/16", 3/8", 7/16", 1/2", 5/8", and 3/4" OD tubing
- Swages 3/16", 1/4", 5/16", 3/8", 1/2", 5/8", and 3/4" OD tubing
- TF275PB storage case included



Metric Bubble Flaring Set

TFM428

Packing: 1

- For automotive brake systems
- Designed for crack free bubble flares on soft wall tubing up to a wall thickness of .028"
- Adaptors included for 4.75, 6, 8, and 10mm flares
- TFM428PB storage case included



Tube Cutting and Double Flaring Set

TF528D

Packing: 1

- Contains TC28C tubing cutter and a double flaring set with a flaring bar, rod handle, yoke, and 5 adaptors (3/16", 1/4", 5/16", 3/8", 1/2")
- Storage case included



Tubing Cutter

TC28C

Packing: 1

- Cuts soft metal tubing ranging from 1/8" to 1" in diameter
- OD capacity is 1/8" to 1 1/8"
- Micrometer type adjustment
- Retractable locking reamer blade
- Cutter wheel is easily replaceable

TC28B1 Cutting Wheel

- Extra cutter wheel for TC28C



Tubing Cutter

TC123C

Packing: 1

- Handles tubing from 1/8" to 5/8" OD
- Can be used where clearance around tubing is less than 1 3/8"
- 1 1/2" long when closed and 2" long when open; feed knob is 7/8" in diameter

TC123CRH Ratcheting Tube Cutter Handle

- Handle for TC123C tube cutter

TC123C1 Cutting Wheel

- Extra cutter wheel for TC123C



Ratcheting Tube Cutter

TC123CR

Packing: 1

- TC123C cutter and TC123CRH handle combined into one unit



Manual A/C Hose Crimper

ACTMAN2100

Packing: 1

- Unit is easily mounted to bench with holding fixture or held securely in a vise
- Includes a complete set of dies covering standard #6, #8, #10 and #12 hose sizes
- Includes storage case



Fin Straightener & Cleaner

ACT407

Packing: 1

- Multi-head tool handles 8, 9, 10, 12, 14, and 15 fins per inch
- 4 1/4" long



Spanner Wrench

ACT499A

Packing: 1

- Adjustable three stud design for GM R-4 compressors
- Also has applications on some GM, Warner, Pitts, and Ogura clutches



Core Service Tool

ACT81290

Packing: 1

- Use on R12/R134a standard valve cores and JRA/EATON large bore R134a valve cores



Orifice Tube Tool

ACT1008A

Packing: 1

- Services A/C systems
- 6 1/4" long
- Manual shut-off valves



Expansion Tube Remover

ACT106B

Packing: 1

- For most GM models
- 4" long
- Manual shut-off valves



Orifice Tube Remover

ACT1009A

Packing: 1

- Use as CCOT and FFOT screen extractor
- Use in conjunction with ACT106B
- Manual shut-off valves



Oil Injector Adaptor

ACT111B

Packing: 1

- Has an aluminum body and holds up to 2 oz. of oil
- Uses pressure differential of the high and low side of A/C system



Universal Valve Core Tool

VT14

Packing: 1

- Double ended wrench removes and installs large and small valve cores
- Reverse the double ended wrench in the tool body to fit both large and small valve cores
- Use the cup end to remove valve caps
- Valve Stem Inserters
- Simplify installation of valve stem in tubeless tire rim
- Shank is notched to accommodate various rim styles
- Has a comfortable, screwdriver type handle
- 12" long



Flush Kit

ACT1046C

Packing: 1

- Provides pressure flushing of condensers, evaporators, and refrigerant lines after the A/C system is completely discharged
- Designed to work with any lightweight flushing material that can be mixed with pressurized air
- Includes flush gun, hose, canister, and canister adaptor



Quick Connect Set

ACT119

Packing: 1

- Simplifies connecting to core valve service fittings
- Includes both a straight coupler and a 90° coupler that accept either of two adaptors (one for low side, one for high side)
- Manual shut-off valves



Valve Stem Inserter

VT1A

Packing: 1

- Simplify installation of valve stem in tubeless tire rim
- Shank is notched to accommodate various rim styles
- Has a comfortable, screwdriver type handle
- 12" long



1/2" Torque Stick Set, 5pcs

BTQS500

Packing: 1

- Entry level set covers the most popular models
- Size ranges from 19 to 22mm
- Torque range from 80 to 147 ft. lbs
- 1/2" drive
- Includes BTQS12B, BTQS12BB, BTQS12C, BTQS12EE and BTQ12SI (5 pcs) in BTQSCASE storage case



1/2" Torque Stick Set, 6pcs

BTQS600

Packing: 1

- Set contains sticks to compliment the BTQS1000 set to cover any applications you may still have
- Size ranges from 17 to 22mm
- Torque range from 55 to 113 ft. lbs
- 1/2" drive
- Includes BTQS12AA, BTQS12F, BTQS12G, BTQS12H, BTQS12K and BTQS12MM (6 pcs) in BTQSCASE storage case



1/2" Torque Stick Set, 10pcs

BTQS1000

Packing: 1

- Master set covers the majority of domestic and foreign cars and light trucks
- Size ranges from 19 to 24mm
- Torque range from 80 to 160 ft. lbs
- 1/2" drive
- Includes BTQS12A, BTQS12B, BTQS12BB, BTQS12C, BTQS12E, BTQS12EE, BTQS12I, BTQS12T, BTQS12XX and BTQS12Y (10 pcs) in BTQSCASE storage case





1/2" Torque Stick

Packing: 1

- Take the guesswork out of tightening lug nuts
- Strobe marks stop turning at precisely the correct torque on each and every job
- Engineered for rugged professional environments
- Manufactured with heat-treated spring steel in a solid one-piece design
- Sticks are individually packaged
- This is an extension - use your existing sockets for different sizes



PART NO.	COLOR	TORQUE LIMIT (ft.lbs)	PART NO.	COLOR	TORQUE LIMIT (ft.lbs)
BLPTSK65	Yellow	65	BLPTSK140	Aqua Blue	140
BLPTSK80	Dark Blue	80	BLPTSK160	Green	160
BLPTSK90	Beige	90	BLPTSK175	Red	175
BLPTSK100	Grey	100	BLPTSK190	Purple	190
BLPTSK120	White	120	BLPTSK200	Brow	200

Gas Cap Adaptor

EELDGASCAP1

Packing: 1

- Quickly pops-on virtually any filler neck
- Costly replacement seals are no longer needed
- One size fits all (new model vehicles may be subject to change)



Wheel Lock Kit

LSR1000A

Packing: 1

- Wheel Lock Removal Socket Set
- Easily removes most lug nuts and wheel locks on most domestic and import passenger vehicles and light trucks
- Use with hand driver or impact wrench
- Some sockets cover specific GM, Ford and Chrysler applications
- Set includes 11 sockets, extension and extractor punch in storage case



Heavy Duty Toyota Oil Filter Tool

OFTOY468

Packing: 1

- Suits all Toyota and Lexus models with cartridge style engine oil filter
- Manufactured from heavy duty chrome vanadium material to withstand loads required to remove frozen oil filter covers
- 65mm across flat
- 1/2" square drive and 24mm (15/16") hex



Hose Nozzle

NOZZLE360A

Packing: 1

- Turns any standard 5/8" hose into a multi-function cleaning tool
- Five different spray patterns for multiple applications
- Wash/rinse vehicles or water plants using a softer, cascading stream
- Clean pools, deck and driveways with heavy duty stream
- Clean service bays, shop floors and blast mud/dirt from vehicles with a powerful jet stream
- 360° jetted nozzle is engineered from rugged extruded aluminum, forged stainless steel, high grade fiberglass and comfort grip santoprene rubber
- Patented 2-way shut off



Line Clamp Set

HCP3KT

Packing: 1

- HCP6A, HCP7A and HCP10A (6", 7", 10") in storage pouch

HCP6A Hose Pinching Pliers

- For sealing hose sizes 1/8" to 5/16"
- Also use on brake lines, fuel lines and vacuum hoses
- 6" long

HCP7A Hose Pinching Pliers

- For sealing hose sizes 1/2" to 3/4"
- Also use on heater hoses and vacuum lines
- 7" long

HCP10A Hose Pinching Pliers

- For sealing hose sizes 3/4" to 2 1/4"
- Also use on radiator hoses
- 10" long



Master Plus Disconnect Set

LDT14

Packing: 1

- LDT14 contains all tools from the popular LDT8, Master Disconnect Set; in addition the kit has:
- The two most popular Jiffy-tite Disconnect tools
- The new blue 5/16" fuel line adapter
- A set of 4 air line push-pull disconnect tools that work on heavy duty trucks and industrial applications
- Label inside cover of carrying case shows images and applications



Master Line Disconnect Set

LDT8

Packing: 1

- A complete set of disconnect tools for spring lock and quick disconnect couplings used on air conditioning and fuel lines on Ford, GM and Chrysler vehicles
- Includes a set of six standard disconnect tools (5/16", 3/8", 1/2", 5/8", 3/4" and 7/8") and six color coded, angled disconnect tools for use in tight spots
- SPECIALIZED GM APPLICATIONS:
Includes tools for use on GM 3/8" flex fuel capable fuel filter removal plus 5/16" and 3/8" GM fuel modules
- SPECIALIZED FORD APPLICATIONS:
Includes tools for use on 3/8" and 1/2" Ford transmission and cooler lines with stepped line plus 5/16" x 3/8" scissor disconnect and Ford coupler disconnect tools



**Gasoline Engine Injector Set**

BPENKIT

Packing: 1

- For test gasoline fuel injection pressure
- Ideal for most American, Asian and European cars
- Set includes pressure gauge, hose, hook for securing gauge to under vehicle's hood, 34 size types of fuel valves
- Blow mold
- **Not to be used on diesel engines

**3/8" Drain Nuts**

BLPODKIT

Packing: 1

- 3/8" sq drive: 15 pcs oil drain kit
- 14 different socket sizes (8-17mm) and 1 pc sliding T-handle bar
- Suitable for transmission, differential and gear oil plugs
- Blow molded case

**Universal Radiator Pressure Test Kit**

RADKIT18

Packing: 1

- Easy to use for testing leaks in radiators by connecting the pressure tester pump to a test cap or adaptor onto the radiator
- Connectors are included to test leaks in pressure cap as well as for releasing pressure
- Includes 13 test caps and adaptors cover a great variety of sizes for most US, Euro and Japan car makes
- Thermometer included for measuring coolant temperature

**Disconnect Set**

ACT1370

Packing: 1

- Set includes six tools for disconnecting spring couplings on fuel lines
- Convenient plastic holder included
- Also useful on A/C spring couplings as well as push lock connectors on radiator and transmission lines
- Includes six tools for disconnecting spring couplings on Ford, GM, and Chrysler A/C lines
- Works on fuel lines and can be used as push lock connectors on radiator and transmission lines
- Included sizes are 5/16", 3/8", 1/2", 5/8", 3/4" and 7/8"



Manual Fluid Dispenser

VAC201

Packing: 1

- Easily remove engine oil, gear and transmission oil, coolant and brake fluids
- Unit creates vacuum or pressure providing a clean, fast and simple way to evacuate or dispense a wide range of fluids
- Automatic shut off prevents the overflow of the reservoir tank with shut off at 8 liters
- 2.3 gallon (8.8 liter) total capacity
- Durable polyethylene construction is impervious to automotive and house hold chemicals
- No electrical or compressed air required
- Sturdy base with exterior pump helps prevent evacuator from tipping
- Complete system includes manual fluid evacuator, main hose assembly (5/16" ID x 54" long) plus two rigid dipstick tubes for engine oil removal (3/16" ID x 34" and 1/8" ID x 34")



Terminal Brush

BTC3A

Packing: 1

- Stiff wire bristles thoroughly clean posts and clamps
- 3 3/8" long



Oil Filter Strap Wrench

BLPOFSW

Packing: 1

- Use on spin-type oil filters up to 6" diameter
- Cold rolled steel bracket
- Strong nylon belt prevent slippage
- Use with 1/2" ratchet



Oil Filter Wrench Set, 7pcs

FWK7A

Packing: 1

- Wrenches in set cover 95% of domestic and import automobile and light truck oil filters
- Storage/carrying case keeps wrenches together for quick access and contains any oil residue keeping it out of your tool storage unit
- Includes laminated application chart
- FWK7A set includes FW656714A, FW757715A, FW7614A, FW7630A, FW8015, FW9315A and FWA62121A oil filter wrenches



Oil Filter Wrenches

Packing: 1



PART NO.	SIZE (mm)	STEPS	FLATS	STYLE
FW656714A	65, 67	2	14	Cup
FW757715A	75, 77	2	15	Cup
FW7630A	76	1	30	Cup
FWA62121A	62, 121	—	—	Adjustable

PART NO.	SQ. DRIVE (inches)	APPLICATION
FW656714A	3/8	Fram-PH4386, PH4967, PH6017, PH6018, PH6607
FW757715A	3/8	NAPA, AC Delco, Castrol, STP, Penske
FW7630A	3/8	Fram, IAPCO, Motorcraft, Parts Plus, Pennzoil
FWA62121A	3/8	Adjustable filter wrench for 62 to 121mm diameter oil filters, 3/4" external hex

Funnel

FUNN15

Packing: 1

- High visibility red funnel for large neck fillers
- Both ends of the funnel have screw on caps to contain fluids if needed
- 1.5 qt. capacity

**18" Hose**

YA752

Packing: 1

- 18" long version of YA751

**12" Hose**

YA751

Packing: 1

- For powered and hands operated grease guns
- 1/8" NPT(m) both ends
- 4,500 maximum PSI
- 12" long

**Nozzle, Needle**

YA750

Packing: 1

- 1/8" NPT(f.) thread
- 2 3/4" long

**Adaptor, Needle Type**

YA801

Packing: 1

- For universal joint fittings, water pumps, and metal covered springs
- 4 7/8" long

**Accessory Pack, Grease-dispensing**

YA7500

Packing: 1

- Includes 10 pcs. as follows in a storage tray
 - Universal swivel
 - Needle nozzle coupler
 - Flex whip hose 12"
 - Flex whip hose 18" (for manual grease guns)
 - Flex whip hose 18" (for powered grease guns)
 - Heavy duty coupler
 - Swivel coupler
 - Coupler
 - Coupler extension
 - Angle lube adaptor

**Serpentine Belt Tool Kit**

YA9350B

Packing: 1

- Hex Applications
 - YA9350-6** (13mm or 1/2") - GM "Quad 4" 2.3L and Volkswagen 2.0L
 - YA9350-2** (14mm) - Isuzu 3.1L, Lexus (2.5L, 3.0L, 4.0L), Mazda (2.3L, 3.0L, 4.0L), Saturn 1.9L with 4mm hex on idler pulley, Toyota 3.0L, Volkswagen (1.8L, 2.5L, 2.8L)
 - YA9350-8** (15mm) - GM 2.2L, Isuzu 2.8L, Jeep 4.7L
 - YA9350-7** (16mm or 5/8") - Ford/Lincoln/Mercury (2.3L, 3.8L, 4.0L, 4.9L, 5.0L, 5.8L), GM (4.3L, 5.0L, 5.7L)
 - YA9350-3** (18mm) - GM (2.0L, 3.1L, 3.3L, 3.4L, 3.8L)
 - YA9350-9** (19mm or 3/4") - Mercedes (use with 15mm adapter for extra reach), Toyota (1.8L, 2.4L)
- Wrench Only - Dodge/Chrysler/Plymouth (3.0L, 3.3L, 3.9L) (has 15mm drive), Ford/Lincoln/Mercury (2.3L, 3.0L, 3.8L)
- Square Applications
 - YA9350-4** (3/8") - Ford/Lincoln/Mercury (1.9L, 2.3L, 2.5L, 4.0L), GM (2.0L, 2.2L, 2.8L, 3.1L, 3.4L), Isuzu (2.8L, 3.1L)
 - YA9350-5** (1/2") - Dodge/Chrysler/Plymouth (2.0L, 3.0L), Ford / Lincoln/Mercury (2.3L, 3.0L, 4.2L, 4.6L)



Serpentine Belt Tool

SBT26

Packing: 1

- Works on all serpentine belts
- Clamping jaw allows user to position serpentine belt without the belt slipping out of the tool
- Positive grip allows belt routing in tight access areas that would normally be difficult to reach
- Ergonomic handle provides comfort and ease in use, acting as an extension of the user's hand
- Lightweight steel body for durability and strength

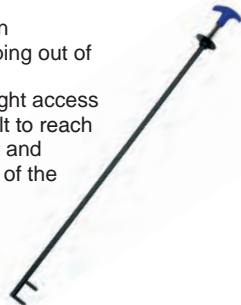

Bearing Race and Seal Driver Set

A1310A

Packing: 1

- Collars fit most standard wheel bearing sizes
- The three largest sizes fit most late model 4 wheel drive vehicles



Throttle Depressor

B240B

Packing: 1

- Holds throttle at a constant RPM
- Easily adjusts to desired length
- Adjustment screw fine tunes desired RPM
- Rubber tip keeps the tool firmly positioned on the accelerator pedal
- Overall length of 40" (102cm)
- Can also be used as a pedal depressor



Ring Compressors

Packing: 1

- Clutch control holds tension band in position as piston is inserted into cylinder
- 1/2" wide spring bands equalize tension over belt width so ring assembly may be compressed into groove until flush with piston
- "V" beads on lower edge of belt keep tool from entering cylinder
- RC40C can be used upside down for Chevrolet, Mercury, and Ford trucks with angled blocks



PART NO.	BAND	CAPACITY (inches)	DEEP (inches)
RC40C	2	2 1/8 to 5	3 1/2
RC50C	2	3 1/2 to 7	3 1/2

Cooling System Pressure Tester

SVT275

Packing: 1

- Inflatable bladder sealing system enables use with most passenger and light commercial vehicles
- Tests header tanks and radiator systems as well as thread type and bayonet-style caps
- Locate leaks from head gaskets, radiator and heater cores, Welch plugs and housings, water pumps and hoses
- Test cap relief pressure and seal condition
- Suitable for marine applications
- Fluid drain tube allows coolant to be returned to reservoir or safely collected for recycling
- Bladders are cycle tested to over 1,500 inflations



Cooling System Adaptor Set

SVTAB1400

Packing: 1

- TAB Series Adaptors feature a composite metal/plastic construction for a lower cost option
- Set includes 14 radiator composite metal/plastic radiator adaptors
- Includes all TAB Series Adaptors plus TA4503 Adaptor
- PBSVTA1417 Storage Case has a removable cover for display purposes



Spreader

GA395

Packing: 1

- For standard four piston caliper disc brakes
- Frees hands to assemble caliper over rotor
- 6 3/4" long



Pad Spreader

YA2440

Packing: 1

- For use on most domestic and import cars and light duty trucks with single piston disc brakes without parking brakes
- Compresses the disc brake piston for easy pad installation



Power Steering Adaptor Kit

YA4008

Packing: 1

- Aids in the removal of trapped air from power steering systems
- Adaptor designed to fit snugly in the neck of the power steering reservoir to form an airtight seal when vacuum applied



Master MacPherson Strut Tool

MSC1

Packing: 1

- Designed to quickly and easily compress most MacPherson strut springs
- Compresses up to 5/8" (.625mm) coil diameter
- Broad spring contact for stable compression
- Acme threaded rod and built in detent latches to help lock coil in place
- Forged construction for strength and durability



Brake Rotor Tool

YA9329A

Packing: 1

- Use to rotate piston back into caliper cylinder when replacing pads
- Also rotates parking brake cylinder back into the caliper cylinder on vehicles with four wheel disc brakes
- For 1975 and later Ford and Mercury plus some imports



Inner Tie Rod Tool

YA3000D

Packing: 1

- Designed to remove tie rods lacking a full hex on the socket end
- Removable crowfoot adaptors are placed on hex of tie rod
- Tool then engages crowfoot for removal or installation of tie rod
- Includes crowfoot adaptors in 1 3/16", 1 1/4", 1 5/16", 1 7/16", 1 1/2" and 33.6mm sizes



Inner Tie Rod Tool

YA3500

Packing: 1

- Removes inner tie rods equipped with completely round end sockets or flats
- Designed to remove and install all inner tie rod sockets up to 1 31/64"
- Wrench head has 3 set screws that tighten against the socket
- Includes 1/4" short head hex wrench



Brake Service Tools

YA4000B

Packing: 1

- Produces vacuum or pressure at the turn of a switch
 - Comfortable ergonomic design
 - One finger trigger vacuum/pressure release
 - Durable, accurate diaphragm type pressure/vacuum gauge
 - Handheld vacuum/pressure pump with 2" compound gauge and rubber boot
 - 12 oz. fluid reservoir bottle with fluid transfer and storage lids plus fluid pick up tube
 - 6 tapered adaptors for connecting to tubing from .09" to .50" ID
 - 2 tapered manifold plugs
 - 2 universal bleed screw adaptors
 - 12 vacuum cap plugs, vacuum line T-adaptor
 - (2) 1/4" ID x 24" long connection tubes with quick-change connector
 - 5/32" ID x 1/4" ID tubing adaptor
 - 5/32" ID x 3" long vacuum test tube
 - Rubber cupped adaptor
 - Master cylinder refill kit
- Applications:
- Vacuum and pressure related engine performance diagnostics and tune-ups
 - Brake bleeding
 - Fluid transfer, evacuation and sampling



Cam Lock Tool Set

ML6000COMBO

Packing: 1

- Includes (4) CC100 Single Cam Clamps and (1) ML6000 Dual Cam Clamp in storage tray
- Single cam clamp can be used on engines where the dual clamp will not fit
- Compact design permits easy operation in confined engine areas
- Simple and easy to use
- Manufactured from high strength industrial polymers which will not corrode or damage engine pulleys
- Dual cam clamp prevent engine damage resulting from incorrect timing
- Maintain valve timing during belt replacement on twin and quad cam engines
- Compact design allows access in transverse engines
- Fits timing gear diameters from approximately 4" (101mm) to 6" (152mm)
- Fits gear spacing from approximately 0.06" (1.6mm) to 3" (76mm)



Coil Spring Compressor

MSC2

Packing: 1

- Removes and installs coil springs quickly and safely
- Compresses coil springs on all passenger cars and pick up trucks
- Features Acme threaded rod



Ring Compressor Set

RC980

Packing: 1

- Works both horizontally and vertically with pliers grip handle
- Has a fine tooth ratcheting mechanism
- Includes 6 hardened steel bands: 2 7/8" to 3 1/8", 3 1/8" to 3 3/8", 3 3/8" to 3 5/8", 3 5/8" to 3 7/8", 3 7/8" to 4 1/8", and 4 1/8" to 4 3/8"



Valve Spring Compressor

CF700B

Packing: 1

- 7/8" to 2 1/2" capacity
- Operates on 90 PSI to 150 PSI, but develops up to 3 times output pressure
- Tool measures 1" x 8"



Strap Wrench

A91E

Packing: 1

- Use on large diameter oil filters 1 to 6"
- Includes both 3/8" and 1/2" square drives





Vacuum Cleaner - Shop

YB30VU

Packing: 1

- Powerful 1300 watts output motor
- Water lift of 100 inch
- 30L HD stainless steel tank
- Wet and dry function
- EVA hose – 3m , Cord – 9m

Available Accessories:

- PET Washable Cartridge Filter
- Big fiber Pre-filter
- Combo Floor Nozzle
- Collection Bag
- 2 rear big wheels
- 2 Steel Wands
- 1 Steel Elbow w/ Air Flow Adjuster
- Round Brush with Horse Hair
- Crevice Tool
- Large Drain
- Polyurethane Adaptor



Industrial Paper

BPAP1

Packing: 1

- Excellent for cleaning off oil and residue from tools, hardware, equipment and mechanical components
- Tough for industrial use
- Lint free to prevent electrostatic charge as well as a clean surface
- Made from cellulous and polypropylene for better absorbability



PART NO.	SIZE (mm)	COLOR	PIECES / ROLL
BPAP1	310 * 340	White	1100

Deluxe Air Vacuum System

AV1000A

Packing: 1

- Ideal for vehicle media installation and body shops plus other applications in need of picking up dust, metal shavings or broken glass
- Large collection bag includes a debris baffle and sliding bag clamp for emptying debris
- Lightweight ergonomic handle design
- Includes 8.7" aluminum extension tube, 8 1/2" plastic extension tube (AV1000A10), flexible extension tube (AV1000A9), pointed nozzle (AV1000A11) and crevice tool with brush (AV1000A8)



PART NO.	AIR CONSUMPTION, AVERAGE, DFM (scfm) [l/min]	SOUND LEVEL, FREE SPEED, (dBa)
AV1000A	3 (21) [84.95]	81.2
SOUND LEVEL, WORKING (dBa)	RECOMMENDED HOSE SIZE (inches)	LENGTH (WITHOUT BAG), INCHES (mm)
81.2	3/8	13 (330)
BRUSH SIZE, inches (mm)	BAG SIZE, inches (mm)	WEIGHT, lbs. (kg)
1 1/8 x 2 5/8 (28.5 x 66.7)	6 1/2 x 11 1/4 (165 x 285)	0.88 (0.4)

Industrial Paper

BPAP2

Packing: 6

- Excellent for cleaning off oil and residue from tools, hardware, equipment and mechanical components
- Tough for industrial use
- Lint free to prevent electrostatic charge as well as a clean surface
- Made from cellulous and polyethylene for softness and finer surface



PART NO.	SIZE (mm)	COLOR	PIECES / ROLL
BPAP2	250 * 350	Green	300

AUTOMOTIVE WORKSHOP EQUIPMENT



Blue-Point®



Professional comprehensive automotive servicing equipment for all your workshop solutions





Pyramid Wheel Aligner

BLP-PYRAMID



- Patented imaging technology provides accurate and real-time measurements that improves productivity
- User-friendly interface with step-by-step instructions for completing even the most complex tasks
- Features such as EZ-TOE*, VODI* and extensive vehicle specification database delivers customer satisfaction, ease of use and accuracy
- High resolution imaging technology delivers accurate, live alignment readings and diagnostic data
- Passive front and rear XD targets improve durability with no electronics to damage
- Lightweight, durable and impact resistant XD targets and AC100 wheel clamps
- Ride Height Measurement* - manual ride height to obtain proper alignment specs for those requiring it
- Help videos are available on how to make the needed adjustment to complete even the most complex task

Highly accurate wheel alignment systems





AC100 Wheel Clamps

- Self-centring design for accurate measurement of vehicle dimensions
- Two-sided claws eliminate accessories and allow reliable clamping even over hub caps
- Accessories available to accommodate larger wheels

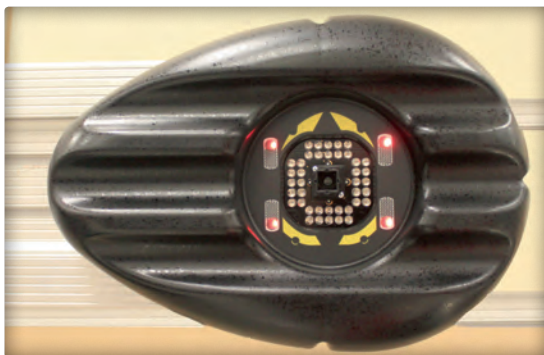

*V.O.D.I.™ Vehicle Orientation Directional Indicator

- Guides the technician through the measurement process



*EZ-TOE

- Turn the front wheels and access difficult adjustment points while still displaying centred toe readings

SPECIFICATIONS

Rim Size	11" - 22" (28 - 56 cm)
Track Width	48" - 96" (122 - 244 cm)
Wheel Base	79" - 180" (201 - 457 cm)
Power Requirements	120/230V, 1Ph, 50/60Hz
Shipping Weight	195 kg
AC100 Weight	11 - 12 lbs (4.9 - 5.2 kg)

ACCESSORIES - Standard

Wheel Clamps and Targets

Steering Wheel Holder

Brake Pedal Depressor

2 x Wheel Chocks

ACCESSORIES - Optional

Part No

AC100 Wheel Clamp Extension Kit	#EAK0268J62A
Paddle Rollback Kit TT	#EAK0277J28A
Quick Clamp Kit	#EAK0268J63A
Tilt Camera Beam	#EAK0289J64A
TIP Target	#EAK0256J71A



Vehicle Dimensions

- Visual reference to a vehicle depicting wheel base, track width difference and front and rear wheels setback

Wheel Balancer

BLP-2D



- Simply start measuring run by closing of wheel guard or pressing START key
- Optimization, spoke mode with hidden weight function and EASYALU mode
- 19" color monitor
- 10 weight compartments with ample space in weight storage and within easy reach of the operator
- User-friendly graphical interface
- Motor drive with V-belt for constant rotational speed during measuring run
- Perfect solution to optimize the working space
- 2D Semi Automatic Parameter Entry (SAPE)



19" monitor with graphical interface

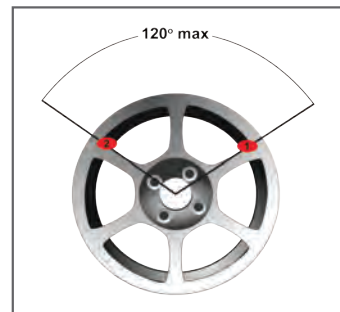

Split weight mode, adhesive weights can be hidden behind adjacent spokes of alloy rim



40 mm shaft diameter for superb stability and balancing of heavy wheels

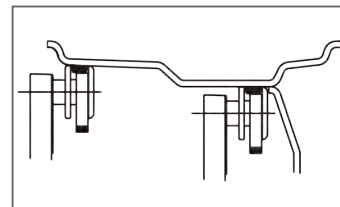

ALU 2P/3P mode for exact weight positioning



Gauge arm equipped with weight clamp retains the wheel weight in the correct position for weight placement



Easy identification of ALU mode with bright LEDs indicating selected weight position

Wheel Balancer

BLP-1D

SPECIFICATIONS	2D	1D
RPI Technology	●	●
1D SAPE	●	●
2D SAPE	●	
Gauge Arm with Wheel Weight Positioning	●	●
LCD Monitor	●	
ALU Mode	5	5
ALU 2P & ALU 3P Mode	●	●
Pax Mode	●	●
Weight Minimization	●	●
Wheel Guard	●	●
Rim Centre Core Diameter	43 - 116 mm	
Shaft Diameter	40 mm	
Measuring Speed	~ 200 rpm	
Measuring Time	6 - 10 sec	
Rim Width (Dynamic)	1" - 16" (3" - 16")	
Rim Diameter	12" - 22"	
Max. Wheel Width with Wheel Guard	400 mm	
Max. Wheel Diameter with Wheel Guard	880 mm	
Max. Wheel Diameter without Wheel Guard	1016 mm	
Max Wheel Weight	65 kg	
Dimensions (L*W*H)	1111x1036x1633 mm	
Weight	89 kg	84 kg
Power Supply	200 - 240V, 1 Ph, 50-60Hz	

ACCESSORIES - Standard	Part No
Quick Nut	#EAA0263G66A
Cone N.4	#EAM0005D25A
Cone N.2	#EAM0005D24A
Cone N.1	#EAM0005D23A
Rim Width Clamp	#EAA0247G21A
Universal Weight Plier	#SBWP10
ACCESSORIES - Optional	
Motorcycle Adaptor	#SEAK0221J86A



- Simply start measuring run by closing of wheel guard or pressing START key
- Hidden weight mode (HSP)
- Weight tray with 10 weight compartments
- Motor drive with V-belt for constant rotational speed during measuring run
- Weight minimization
- Compact foot print occupying minimum floor space
- In ALU modes (ALU2P and ALU 3P) accurate location of weight position inside the rim with gauge arm

Tyre Changer, Tilt-Back

BLP-TILT BACK



- Pressure limiter, air filter and oil reservoir for lubricant to ensure the safe operation and durability of the machine
- Mount / demount tools with plastic protection prevent any damages on the alloy rim during operation
- The special design of the tilt-back post guarantees minimum tension even when hard tyres are mounted or demounted
- High ground clearance of foot pedals facilitate operations during mounting and demounting
- Tried, tested and proven clamps with covered sliding grooves ensure operator's safety

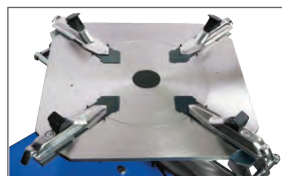

Centre clamp design with covered sliding grooves ensure operation safety



Tried, tested and proven clamps with plastic protection on existing machines are used

SPECIFICATIONS	Tilt-back
Tire Lever	•
Manual Inflator	•
Plastic Protector for Clamping Jaws	•
Holder for Tire Lubricant Container	•
Plastic Protector for Mounting Tools	•
MH	Optional
Servicing Unit with Pressure Relief Valve and Oiler	•
Maximum Wheel Diameter	39" (1000 mm)
Maximum Tire Width	13" (330 mm)
Inner Clamping Range	12" - 22"
Outer Clamping Range	10" - 20"
Turntable Speed	6.5 rpm
Bead Breaking Force	10 kN
Compressed Air Supply	8 - 12 bar
Power Supply	230V, 1 Ph, 50-60Hz 380V, 3 Ph, 50-60Hz
Weight	173 kg
Dimensions (D*W&H)	1040x892x1770 mm

ACCESSORIES - Optional	Part No
Pneumatic Mounting Tool	EAA0382G97A
Motorcycle Mounting Head	SEAA0332G35A
Motorcycle Adaptor for centre tyre jaws	SEAA0329G48A
Motorcycle Bead Breaker Blade	SEAA0247G14A
Slip-on Shoe	S40291123

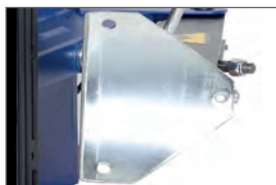

Oversize bead breaker blade handles rims most gently (additional plastic protectors available as an option extra)



Pressure limiter, air filter and oil reservoir for lubricant to ensure the safe operation and durability of the machines

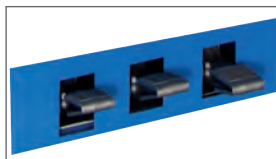

High ground clearance of foot pedals facilitate operation with steel-tipped boots



Tyre Changer, Tilt-Back, 24"

BLP-TILT BACK 24



- Ergonomically designed with safety features, ideal for handling passenger cars, light trucks and high performance wheels.
- Handles wide variety of tyre stiffness rim sizes up to 24" and precise pneumatic locks in working position
- Rigid design to reduce possibility to harm rim and tyre bead of low profile and run-flat wheels



Pneumatic locking of the post in working position ensures precision. Pneumatic pedal-operated tilting adds user friendliness.



For mounting/demounting low profile and run-flat tyres

SPECIFICATIONS	Tilt-back 24"
Tire Lever	•
Manual Inflator	•
Plastic Protector for Clamping Jaws	•
Holder for Tire Lubricant Container	•
Plastic Protector for Mounting Tools	•
MH	Optional
Servicing Unit with Pressure Relief Valve and Oiler	•
Maximum Wheel Diameter	39" (1000 mm)
Maximum Tire Width	13" (330 mm)
Inner Clamping Range	12" - 24"
Outer Clamping Range	10" - 24"
Turntable Speed	6.5 rpm
Bead Breaking Force	10 kN
Compressed Air Supply	8 - 12 bar
Power Supply	230V, 1 Ph, 50-60Hz, 17A
Weight	230 kg
Dimensions (D*W*H)	1700x1300x1910

ACCESSORIES - Optional	Part No
Pneumatic Mounting Tool	EAA0382G97A
Motorcycle Mounting Head	SEAA0332G35A
Motorcycle Adaptor for centre tire jaws	SEAA0329G48A
Motorcycle Bead Breaker Blade	SEAA0247G14A
Slip-on Shoe	S40291123



Larger turntable for 24" rim clamping capability



Adjustable 4-jaw clamp - self centering nylon covered clamp protects and securely grip the wheel



Top inflation kit - enhanced wheel inflation for big or difficult tyres

Tyre Changer, Swing-Arm

BLP-SWING ARM



SPECIFICATIONS	Swing-arm
Tyre Lever	•
Manual Inflator	•
Plastic Protector for Clamping Jaws	•
Holder for Tire Lubricant Container	•
Plastic Protector for Mounting Tools	•
Servicing Unit with Pressure Relief Valve & Oiler	•
Maximum Wheel Diameter	39" (1000 mm)
Maximum Tire Width	13" (330 mm)
Inner Clamping Range	12" - 22"
Outer Clamping Range	10" - 20"
Turntable Speed	6.5 rpm
Compressed Air Supply	8 - 12 bar
Power Supply	230V, 1 Ph, 50-60Hz 380V, 3 Ph, 50-60Hz
Weight	200 kg
Dimensions (D*W*H)	1040x1550x1770 mm

- Rugged and robust design to withstand the demanding environment of a workshop
- Swing-arm design that is suitable for a wide range of rim and wheel sizes
- 14 mm thick square turntable to withstand the increased bending forces when handling large and low-profile tyres

ACCESSORIES - Optional	Part No
Motorcycle Mounting Head	SEAA0332G35A
Motorcycle Adaptor for centre tyre jaws	SEAA0329G48A
Motorcycle Bead Breaker Blade	SEAA0247G14A
Slip-on Shoe	S40291123

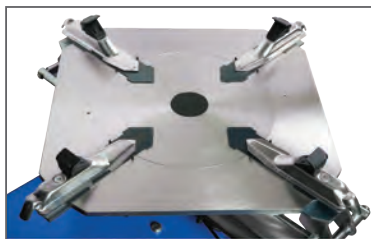

Centre clamp design with covered sliding grooves ensure operator safety



Pressure limiter, air filter and oil reservoir for lubricant to ensure the safe operation and durability of the machines



Tried, tested and proven clamps with plastic protection on existing machines are used

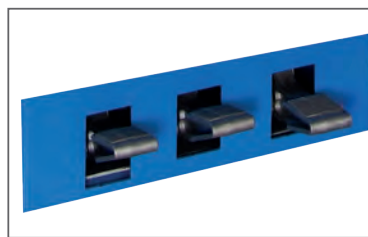

High ground clearance of foot pedals facilitate operation with steel-tipped boots

Scissor-on-Scissor Lift, 3.5 Ton

BLP-SOS 3.5T



- With 3.5 ton lifting capacity for primary and secondary platform
- Primary platform design - eliminate the requirement for additional roller jack and also having a clear obstructed working area between the platform
- Without columns, compact and space-saving design
- Dual engaging twin interlocking mechanical safety lock with pneumatic release

SPECIFICATIONS	
Drive	Electric Hydraulic
Maximum Capacity	3.5 ton
Overall Length	4300 mm
Primary Runway Length	4000 mm
Secondary Runway Length	1400 mm
Overall Width	2160 mm
Primary Platform Width	620 mm
Secondary Platform Width	550 mm
Width between Runways	920 mm
Minimum Wheel Base - 4 wheel alignment	1915 mm
Maximum Wheel Base - 4 wheel alignment	3280 mm
Rear Slip Plate Length	1517 mm
Primary Lift Height	1860 mm
Secondary Lift Height	456 mm
Runway Initial Height	330 mm
Primary Lifting / Lowering Time	40 - 60 sec
Secondary Lifting / Lowering Time	10 - 30 sec
Working Temperature	5° - 40° C
Air Supply Requirements	8 - 10 bar
Power Supply	380V, 3 Ph, 50Hz 220V, 1 Ph, 50-60Hz

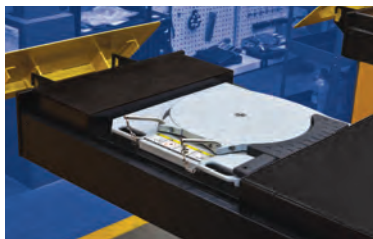

Turntable pocket



15 level locking positions with pneumatic lock release system



Full height (1860mm) for stand-up comfort during alignment adjustment



Secondary lifting platform

2-Post Lift, 4 Ton, Clear Floor

BLP-CF 4T



- Suitable for car and light trucks up to 4 ton
- Symmetric - large swing arm area designed to cater for various lifting positions
- Secure - rubber doors guard prevent damages when moving in/out of the vehicle. Heavy duty arm restraints and hydraulic hose guards designed to be safe and long lasting
- Smooth lift operation - nylon glide blocks are used to provide durable and smooth operation
- Arm pads - adjustable screw with stackable rubber lifting pad

SPECIFICATIONS	
Capacity	4.0 ton
Overall Width	3402 mm
Width between Columns	2752 mm
Drive-thru Width	2437 mm
Overall Height	3705 mm
Under Bar Clearance	3593 mm
Height to Lowered Lift Pad	114 mm
Height to Raised Low Lift Pad	159 mm
Arm Type	2-stage
Arm Design	Symmetric
Front Arm	802 - 1202 mm
Rear Arm	802 - 1202 mm
Maximum Lifting Height	1756 mm
Lift Time / Lower Time	50 / 40 sec
Safety Valve	Yes
Mechanical Safety Latches	Yes
Type of Equalization	Cable
Hydraulic System	Chain over
Hydraulic Cylinder with Double Seal	Yes
Overhead Limit Switch	Yes
Mechanical Safety Lock	2 sides manual
Double Telescopic Pad Screw	Optional
Door Guard	Yes
Power Supply	380V, 3 Ph, 50Hz 220V, 1 Ph, 50-60Hz



Safety shut-off bar

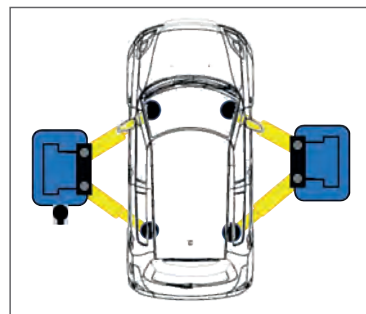

2-stage arms for Clear Floor and Base Plate



2-Post Lift, 4 Ton, Base Plate

BLP-BP 4T



SPECIFICATIONS

Capacity	4.0 ton
Overall Width	3402 mm
Width between Columns	2752 mm
Drive-thru Width	2437 mm
Overall Height	2831 mm
Arm Type	2-stage
Arm Design	Symmetric
Front Arm	802 - 1202 mm
Rear Arm	802 - 1202 mm
Lifting Pad	100 - 147 mm

ACCESSORIES - Optional

Part No

Heavy Duty Height Extension Adaptors	
50 mm	SEAM0090T84A
100 mm	SEAM0090T83A

- An ideal solution for low ceiling workshop
- Heavy duty chain over electric hydraulic lifting with cable equalization
- 2831 mm overall column height
- Heavy duty column with symmetrical 2-stage front and rear arms



Heavy duty arm restraints





























Electro-hydraulic chain over system

Important Words About Safety for Users and Bystanders

Following these basic safety rules is a good start toward protecting yourself and others in the vicinity from injury while using tools

- Wear safety goggles
- Use the right tool
- Use the tool properly
- Maintain the tool regularly
- Keep tools away from children
- Do not use tools on live electrical circuits unless specifically designed for such use
- Read and follow instructions

Prohibited Actions	Mandatory Actions	Hazard Alerts
 THIS SYMBOL INDICATES PROHIBITED ACTION	 THIS SYMBOL INDICATES MANDATORY ACTION	 THIS SYMBOL INDICATES A HAZARD ALERT RED BACKGROUND – DANGER ORANGE BACKGROUND – WARNING YELLOW BACKGROUND – CAUTION
 DO NOT OVER-TORQUE NO PIPES OR LEVER EXTENSIONS	 MANDATORY EAR PROTECTION	 VIBRATION HAZARD
 NO HAMMERING	 MANDATORY FACE SHIELD	 RISK OF EXPLOSION
 NO PRYING	 MANDATORY MASK	 OVERHEAD/OVERLOAD HAZARD
 DO NOT STRIKE HARD OBJECTS	 MANDATORY RESPIRATOR	 RISK OF ELECTRIC SHOCK
 NO IMPACT/POWER DRIVE	 MANDATORY PROTECTIVE CLOTHING	 RISK OF FIRE
 DO NOT STEP IN OR ON DRAWERS	 MANDATORY PROTECTIVE GLOVES	 RISK OF ENTANGLEMENT
 DO NOT OPEN MULTIPLE DRAWERS	 MANDATORY EYE PROTECTION	
 DO NOT PULL TO MOVE	 MUST READ INSTRUCTIONS BEFORE USE	
 KEEP CHILDREN AWAY		

Safety messages in this catalog use the guidelines of the American National Standard ANSI Z535. 4 for Product Safety Signs and Labels and ANSI Z535.3 Criteria for Safety Symbols. Messages associated with specific products use a triangular hazard alert symbol, signal word (CAUTION, WARNING, DANGER) and how to avoid the hazard.

PLEASE READ AND FOLLOW these messages to avoid injury to yourself and bystanders.

1/4"

1/4" Square Drive Tools

Adaptors	51-52
Automotive Tool Kit Set	11,13,18
Bit Socket Sets	4,18-20,52
Bit Sockets.....	46-50
Breaker Bar	50
Extensions	51
Handles	50,133
Impact Wrench	156
Ratchets	45,161-162
Sockets, Torx®.....	47-48
Socket Drivers	
Torx®.....	47-48
Hex	48-49
Phillips®.....	49
Pozidriv®.....	49
Flat Tip.....	50
Triple Square.....	50
Universal Joints	51

1/4" & 1/2"

1/4" & 1/2" Square Drive Tools

Socket & Tool Kit Set.....	16
----------------------------	----

1/4" & 3/8"

1/4" & 3/8" Square Drive Tools

Socket Kit Set.....	15
---------------------	----

1/4" & 3/8" & 1/2"

1/4" & 3/8" & 1/2" Square Drive Tools

Automotive Tool Kit Set	11,13
Sockets, Torx®.....	15
Socket & Tool Kit Set.....	12
Socket & Wrench Kit Set	14

3/8"

3/8" Square Drive Tools

Adaptors	60-62
Automotive Tool Kit Set	21
Bit Socket Sets	4,21-23
Bit Sockets.....	55-59
Breaker Bar	58
Extensions	59,60,62
Handles	58,59
Impact Socket Set	24
Impact Swivel Socket	62
Impact Wrench	156,158
Ratchets	54,162-163

Sockets, Torx®.....	56-57
Socket Drivers	
Torx®.....	56-57
Hex	57
Phillips®.....	58
Pozidriv®.....	58
Flat Tip.....	58
Triple Square	58
Socket & Wrench Kit Set	23
Universal Joints	60,62

1/2"

1/2" Square Drive Tools

Adaptors	68,71
Bit Sockets.....	63-67
Breaker Bar	67
Bit Socket Sets	4,24,25
Extensions	68,71
Flip Impact Socket Set.....	71
Handles	67
Impact Socket Set	25
Impact Sockets.....	69
Impact Swivel Socket	70
Impact Wrench	158-159
Plastic Lug Socket Set.....	70
Ratchets	63, 163
Sockets, Torx®.....	65,66
Torque Stick Set.....	231-232
Universal Joints	68

3/4"

3/4" Square Drive Tools

Adaptors	74
Bit Sockets.....	72
Breaker Bar	71
Extensions	72,74
Handles	71
Impact Sockets.....	73-74
Impact Swivel Socket	74
Impact Wrench	159
L-Shape Wrench.....	71
Ratchets	71
Universal Joints	72,74

1"

1" Square Drive Tools

Adaptors	76
Impact Sockets.....	75
Extensions	76
Universal Joints	76

A

Abrasion Resistant Nitrile Gloves	207
Accessories	
Adaptor, Air Line	178
Couplers, Air	178
Adaptor	
1/4" Drive	51-52
3/8" Drive	60-62
1/2" Drive	68,71
3/4" Drive	74
1" Drive	76
Air Line	178
Cap	232
Cooling System	237
Power Steering	238
Needle Type	236
Oil Injector	230
Set	237
Spinner	51
Adaptor Sets	
Cooling System	237
Adjustable	
Joint Pliers	114,119
Pliers	216
Torque Wrenches	79-80
Wrenches	5-6,91-92
Air	
Grease Gun	220
Hammer	161
Hoses	177
Line Couplers & Adaptors	178
Riveter	219
Shears	168
Screwdriver	172-173
Vacuum	240
Valve	187
Aluminum Flashlight	189
Amp	
Meter	195
Angle	
Drill	160
Grinder	164-167
Locator	183
Shears	150
Antifreeze Hydrometer	186
Automatic	
Center Punch	146
Meter	193
Wire Stripper	214
Automotive	219
Amp Meter	195
Tool Sets	11,13,18,21,26

B

Bags	
Tool	42
Tote	41
Backpack	42
Ball Hex	
Bit Set	134
Ball Peen Handle	140
Battery	
Carrier	196
Tester	191
Charger, Shop	191
Bearing Race & Seal Driver Set	237
Belt Sander	169
Belt Tools	236-237
Bench	
Vise	222
Work	213
Bendable Light	190
Bender, Tubing	225
Bit Sockets	
Stubby, 1/4" Drive	20
Torx®, Tamper Resistant	48-49,57
Torx®, Set	15
Bits	
Drill	177
Screwdriver	135
Set, Power	134
Sets	134,136
Blade	
Knife	152
Utility Knife	152
Blow Gun	174
Body	
Hammers	26
Bolt Cutters	126
Boot Pliers	215
Borescope	192
Bottle Jacks	212
Box	
Metal Tool	40
Plastic Tool	41
Pry Bar	36
Wrench, Ratcheting	104
Brake	
Caliper Kit	188
Caliper Press	188
Gauge Set	188
Rotor Tool	238
Service Tools	238
Spring Tool	188
Brass Hammer	145
Breaker Bar	
1/4" Drive	50
3/8" Drive	58
1/2" Drive	67
3/4" Drive	71
Brush	
End	176
Terminal	235
Wire	176

C

Cabinet	
Roll	30-32
Side	34
Top	36
Cable, Cutters.....	117,214
Caliper	
Dial	184
Digital.....	184
Brake	188
Cam Lock Tool Set.....	239
Can Holder	36
Car Body Hammer Set	26
Carrier, Battery	196
Carts	37-39,224
C-Clamp	
Compressor.....	223
Locking	122
Pliers.....	122
Chain	
Wrench	97
Pliers.....	123
Chests, Top	33-34
Chisel, Punch Set	146-147
Circlip Pliers.....	9,125-126
Circuit	
Tester	195
Clamping Pliers	122,126
Clamp, Line	233
Claw Hammer.....	144
Cleaner & Fin Straightener.....	229
Click-Type Torque Wrenches	
Adjustable.....	79-80
Preset	80-81
Coarse Flat File	149
Cobalt Drill Bit Set	177
Coil Spring Compressor	239
Combination	
Measuring Set	184
Pliers.....	114,118-120,201
Wrenches	5,7,89-90,98
Ratchets	7,98-103
Regulator, Air Line.....	174
Compact	
Flashlight	189
Impact Wrench	158
Grinder.....	168
Composite	
Impact Wrench	156,159
Wrenches	92
Compressor	
C-Clamp	223
Coil Spring	239
Ring	237,239
Valve Spring	239
COMPUTORQ 3 Digital Torque	
Wrench	84
Connector	230

Cooling	
System, Adaptor Set.....	237
System, Pressure Tester.....	237
Core	
Service Tool.....	229
Tool, Universal Valve.....	230
Coupler	
Air Line	178
Creeper.....	206
Crimping Tools	176,215,229
Cross Peen Hammer	142
Curve Claw Hammer	144
Curved Fiberglass Prybar.....	223
Cut Off	
Tools.....	167
Wheels.....	175
Cutter	
Bolt	126
Cable	117,214
Diagonal	116-117,120
End	116
High Leverage	117-118
Hose	214
Insulated	201
Leverage.....	214
Micro.....	214
Miniature.....	120
Multi-Purpose	152
Plastic	117
Ratcheting	228
Tube	228
Vinyl.....	151
Wire	214

D

Deburring Tools	225
Deluxe Air Vacuum System.....	240
Depth Micrometer Set.....	185
Diagonal Cutters.....	116-117,120
Dial Gauges.....	187
Dial Indicators.....	184,186-187
Die	
Grinder.....	163-166
Set	225
Diesel, Leak Tester.....	196
Digital	
Caliper	184
Drum Gauge	188
Micrometers.....	185
Tester	86
Tire Inflator	186
Thermometer	186
Torque Wrench.....	84
Disconnect Tools	
Master.....	233
Set	234

Dispenser	235
Dividers.....	183
Document Holder.....	36
Door Lockout Set.....	218
Double End	
Ratcheting Wrench	7,102
Wrench	6-7,93,95,102
Double Square	
Socket, 1/4" Drive.....	47
Double Flaring Tool Sets.....	227-228
Drain Nut	234
Drawer	
Cabinet	30-32
Roll Cart.....	38-39
Top Chest.....	33-34
Drill	
3/8"	160
1/2"	160
Angle	160
Bit, Sets	177
Bit, Step	177
Micro.....	160
Spotweld.....	161
Step, Bit	177
Driver	
Flat Tip.....	50,58
Hex, Bit	48-49,57,67
Phillips®.....	49,58
Pozidriv®.....	49,58
Set, Bearing Race & Seal.....	237
Socket.....	48-50,57-58,66-67
Square Drive.....	50,58,67
Stubby	49
Torx®.....	48,57,66
Triple Square	50,58,67
Dual	
Action, Sander	170-171

E

Ear Protection.....	208
Electronic	
Micrometers.....	185
Stethoscope.....	195
End	
Brush	176
Cutters	116
Engine	
Crane.....	212
Stethoscope.....	195
Injector.....	234
Exhaust Hanger Removal Pliers.....	215
Expansion Tube Remover	229
Extension	
1/2" Drive.....	68,71
1/4" Drive.....	51
3/8" Drive.....	59-60,62
3/4" Drive.....	72,74

1" Drive	76
Flexible, 1/4" Drive.....	51
Insulated.....	199
Knurled, 3/8" Drive.....	59
Knurled, 1/2" Drive.....	68
Locking, 1/4" Drive.....	51
Locking, 3/8" Drive.....	59
Locking, 1/2" Drive.....	68
Lug Nut.....	70
Socket.....	70
Extra Long	
Hex	106-108
Torx.....	106
Pliers.....	113
Extractor Set.....	219

F

Face Shield.....	208
Fan Clutch Pulley Holder.....	97
Feeler Gauges.....	181-183
Fiberglass Hammer	145
Prybar	223
File	
Flat.....	149
Round	149
Set	10,149
Triangular	149
Filter	
Oil.....	216,232,235
Pliers.....	216
Toyota.....	232
Wrenches	235
Fin Straightener & Cleaner.....	229
Finger Ratchets	45,54
Flap Wheels and Disc.....	175-176
Flare Nut Wrench	96
Flaring Tools, Tubing.....	227-228
Flashlights	
Aluminum.....	189
Compact	189
UV Leak Detection.....	209
Flat File.....	149
Flat Tip	
Bits.....	135
Socket Driver.....	50
Flex Head	
Ratchet	98-101,103
Ratchet, Combination	98-100
Ratchet, Locking.....	103
Wrench, Locking.....	103
Wrench, Ratcheting	98-99,101
Flexible	
Extensions, 1/4" Drive	51
Lights	191
Flip Impact Socket.....	71
Flip-Top, Roll Cart	38
Flood Light.....	190

Floor Jacks	209-210
Fluid Dispenser, Manual.....	235
Flush Kit.....	230
Folding	
Tray	36
Hex Keys	105
Funnel.....	236
Fuse	
Buddy®.....	195

G

Gas	
Adaptor, Cap	232
Leak Tester.....	196
Gasoline Engine Injector Set.....	234
Gauge	
Air Adjusting	187
Brake	187
Drum.....	188
Feeler	181-183
Pressure, Tire	187
Set	187-188
Tire	187
Tread Depth.....	187
Glasses, Safety	208
Gloves	
Abrasion Resistant	207
Nitrile	207
Washable	207
Welding.....	207
Grease	
Dispenser	236
Guns	220
Guns, Lever.....	220
Grinder	
Compact	168
Angle	166-167
Die	163-166
Die, Kit.....	166
Wheel	175
Gun	
Air, Grease	220
Blow.....	174
Grease.....	220
Oil	221
Spray	221
Suction.....	221

H

Half Round 2nd-Cut file	149
Hammer	
Air	161
Ball Peen	140
Body	26

Brass	145
Claw.....	144
Cross Peen.....	142
Fiberglass	145
Rubber Mallet	143
Sets	10
Soft Blow	142
Soft Face	140,142
Wheel	145
Wrench, Impact	158
Handles	
1/4" Drive	50,133
3/8" Drive	58-59
1/2" Drive	67
3/4" Drive	71
Scraper.....	148
Hacksaw	
Junior.....	152
Mini	152
Headlight, LED	191
Heavy Duty	
Bolt Cutters.....	126
Mini Cart	37
Oil Filter	232
Polisher.....	170
Sander	169
Scissors	151
Shears	150
Workbench	213
Helmet, Welding	209
Hex	
Bit Sockets, 1/4" Drive.....	48-49
Bit Sockets, 3/8" Drive.....	57
Bit Sockets, 1/2" Drive.....	67
Bits.....	135
Bits, Set	134
Keys.....	105-108
Key Sets	105-106
High Leverage, Pliers, Cutters.....	117-118
High Speed, Sander	170
High Torque Ratchet	163
Holder	
Can	36
Document	36
Fan Clutch Pulley	97
Tool, Magnetic.....	184,216
Hose	
12"	236
18"	236
Air	177
Crimper.....	229
Cutter.....	214
Nozzles.....	233
Pliers.....	113,126
Replacement	226
Hoses, A/C	229
HSS Drill Bit Set	177
HVLP Spray Gun	221
Hydrometer.....	186

I

Impact, 1/4" Drive	
Adaptor	52
Socket Set	52
Impact 3/8" Drive	
Adaptor	62
Sockets	61-62
Socket, Set	24
Impact 1/2" Drive	
Adaptor	71
Sockets	69
Socket, Set	25
Impact, 3/4" Drive	
Adaptor	74
Sockets	73-74
Impact	
Wrench	156,158-159
In Line Sander	169
Industrial Paper	240
Inflator, Gauge	187
Infrared Thermometer	186
Inner Tie Rod Tools	238
Inside Micrometers	185
Inspection Mirrors	196
Insulated	
Cutters	201
Extension	199
Hex Key	201
Pliers	201-202
Wrench	199-201
Wrench Sets	198
Socket	199
Screwdrivers	202
Toolbox Sets	198
Interchangeable	
Heads, Ratcheting	82
Torque Wrench	81

J

Jack	
Bottle	212
Trans	211
Floor	209-210
Motorcycle	210
Stands	211
Junior Hacksaw	152

K

Key	
Ball End	105-106,108
Folding	105
Insulated Hex	201
L-Hex	105-108
L-Torx	106,108
Long, Extra Arm	105-108
Short Arm	105,107-108
T-Hex	105

Knife, Utility	152
Knotted Wire Wheel	176

L

Large Combination Wrench	5
Leak Detector/Tester	
Gas	196
Diesel	196
Ultraviolet	209
Leverage Hose Cutter	214
Lifts, 2-Post, Scissor-on-Scissor	250
Lights	
Bendable	190
Flashlights	189,209
Flexible	191
Flood	190
Leak Detection	209
LED	190-191
Magnetic	191
Pen	189
Rechargeable	190
Shop	190
Under Hood	190
Work	191
Line Clamp Set	233
Lock	
Cam, Tool	239
Wheel	232
Lockout, Door Set	218
Locking	
Extension, 1/4" Drive	51
Extension, 3/8" Drive	59
Extension, 1/2" Drive	68
Flex Head Ratchet Combination	103
Pliers	122-123
Pliers, Clamp	122
Ratcheting Wrenches	103
Long Reach Pliers	112-114
L-Shaped	
Hex Wrenches	105-108
Torx® Wrenches	8,106,108
Wrenches	8,71
Lug Nut Tools	70

M

M Series	
Phillips®	129
Pozidriv®	130
Screwdriver	129
Torx®	9,130
Machinist's Measuring Set	184
Magbender LED Work Light	191
Magnetic	
Holder	184,216
Trays	35
Work Light	191

Mallet, Rubber Head.....	143,144
Manifold	
Repair Kit.....	226
Set.....	226
Manual	
A/C Hose Crimper.....	229
Fluid Dispenser.....	235
Master	
Line Disconnect Set.....	233
MacPherson Strut Tool.....	238
Master Ball Hex Bit Set.....	134
Max Fuse Buddy®.....	196
Measuring	
Sets.....	184
Tapes.....	183
Metal Tool Boxes.....	40
Meter Manual Ranging.....	193
Meter.....	195
Automatic.....	193
Ranging.....	193
Metric Tools	
Socket, 1/4" Drive.....	52
Flaring Tools.....	227-228
Taps & Dies.....	225
Micro	
Cutter.....	214
Drill, 1/4".....	160
Polisher.....	172
Sander.....	171
Shears.....	214
Surface Prep.....	171
Saw.....	168
Wire Cutter.....	214
Micrometers	
Depth.....	185
Digital.....	185
Inside.....	185
Outside.....	185
Rotor.....	188
Mini	
Cart, Heavy Duty.....	37
Hacksaw.....	152
Grinder.....	165
Impact Wrench.....	156
Ratchet.....	162
Spray Gun.....	222
Stethoscope.....	195
Tool Box.....	40
Miniature	
Cutters.....	120
Pincers.....	121
Pliers.....	113-114,120-121,125-126
Mirror, Inspection.....	196
Motorcycle	
Floor Jack.....	210
Multimeter.....	194
Multi-purpose Cutter.....	152
Multi-Tool Set.....	217

N

Needle	
Nose Pliers.....	116
Nozzle.....	236
Nibber.....	169
Nut Socket.....	70

O

Offset Wrenches.....	93
Oil	
Adaptor.....	230
Drainer.....	217
Filter Tool.....	232
Filter, Pliers.....	216
Filter, Wrenches.....	235
Suction Gun.....	221
Oil Filter	
Pliers.....	216
Wrenches.....	235
Tool.....	232
Open End	
Head.....	82
Wrench Set, Double Open End.....	6,95
Orifice	
Tube Tool.....	229
Outside Micrometers.....	185
Oval Tube Creeper.....	206

P

2-Post Lift.....	251-252
P Series	
Phillips®.....	131-132
Screwdriver.....	132
Pad	
Spreader.....	237
Wool Vecro.....	176
Pen	
Light.....	189
Test.....	196
Pencil Die Grinders.....	165-166
Phillips®	
Bits.....	135
Bit Sockets.....	49,58
Screwdrivers.....	129,131-132
Pick Sets.....	213
Pick Up Tools.....	205-206
Pincers.....	121
Pinch Bar.....	223
Pistol	
Air, Screwdriver.....	172
Ratchet Screwdriver.....	133
Pistol Grip, Grease Gun.....	220
Plastic	
Cutters.....	117
Tool Boxes.....	41
Pliers	
Adjustable Joint.....	114,119
Bent Nose.....	116,121
Chain.....	123
Boot.....	215
Circlip.....	9,125-126
Clamping.....	126
Combination.....	114,118-120,201
Duck Bill.....	121
Extended Reach.....	113
Exhaust Hanger Removal.....	215

Grip.....	113,123
High Leverage.....	118
Hose.....	113,126
Insulated.....	201-202
Locking.....	122-123
Long Nose.....	116,118-119,121,201
Long Reach.....	112-114
Miniature.....	113-114,120-121,125-126
Needle Nose.....	116,121
Oil Filter.....	216
Removal.....	116,215
Retaining Ring.....	123-124
Round Nose.....	120
Seal.....	216
Sets.....	8,11,112-114,123-124
Slip Joint.....	114,119,202
Soft Grip.....	123
Straight Jaw.....	123,125-126
Standard.....	8,112
VDE.....	8
Wire Stripping.....	202
Wrench.....	6
Plug	
Coil-On, Probe.....	195
Style, Ear Protector.....	208
Polisher	
Micro.....	172
Heavy Duty.....	170
Protector	
Ear.....	208
Pocket Digital Thermometer.....	186
Portaset 4 Ton.....	211
Power	
Adaptor.....	238
Air, Shears.....	168
Bit Sets.....	134
Pozidriv®	
Bit Socket Driver.....	49,58
Screwdriver.....	130
Post Lift.....	251-252
Precision Screwdriver.....	9,132
Preset Torque Wrenches.....	80-81
Pressure	
Tester.....	237
Gauge.....	187
Probe	
Coil-On-Plug.....	195
Quick, Universal EFI.....	195
Prybar	
Box.....	36
Fiberglass.....	223
Set.....	223
Pulley.....	97
Punch	
Centre.....	146
Chisel Set.....	146
Set.....	146-147

Q

Quick Release Ratchets.....	45,54,63,71
-----------------------------	-------------

R

Radiator Pressure Test Kit.....	234
Ratchet	
1/4" Drive.....	45,133,161-162
3/8" Drive.....	54,162-163
1/2" Drive.....	63,163
3/4" Drive.....	71
Combination.....	98-103
Finger.....	45,54
Flex Head.....	98-101
Flex Head, Locking.....	103
Handle.....	133
Head.....	101
Torque.....	163
Mini.....	162
Pass Thru.....	45,54
Screwdriver.....	133
Quick Release.....	45,54,63,71
Ratchet, Sockets & Accessories.....	43-76
Ratcheting	
Box Wrenches.....	104
Combination.....	7,101-103
Cutter.....	228
Double Ring.....	7,102
Flex Head.....	98-101
Locking, Flex Head.....	103
Interchangeable Head.....	82
Set.....	7,98-99,101,103-104
Short.....	101
Wrench.....	98-99,101,103
Wrench, Insulated.....	201
Rechargeable Bender Light.....	190
Reciprocating Saw.....	168
Regulator, Air Line.....	174
Repair Kit, Manifold.....	226
Replacement	
Hose.....	226
Jaws.....	126
Retaining Ring Pliers.....	123-124
Reversible	
Cut-Off Tool.....	167
Ratcheting Wrench.....	104
Sander.....	170
Ring	
Compressors.....	237,239
Wrench.....	7,93,102
Rivet Tool, Riveter.....	219
Roll Cab.....	30-32
Roll Cart	
1 Drawer.....	38
2 Drawers.....	38
2 Shelves.....	37
4 Drawers Flip-Top.....	38-39
4 Drawers Sliding Top.....	39

Rotor	
Micrometer.....	188
Brake, Tool.....	238
Round	
2nd-Cut File.....	149
Half, 2nd-Cut File.....	149
Nose Pliers, Miniature.....	120
Rubber	
Head Mallet.....	143-144

S

Safety Glasses.....	208
Sander	
Belt.....	169
Dual Action.....	170-171
Heavy Duty.....	169
High Speed.....	170
Micro.....	171
Reversible.....	170
Saw, Reciprocating.....	168
Scissor-On-Scissor Lift.....	250
Scissors, Shop, Heavy Duty.....	151
Scraper.....	148
Screw Removal Pliers.....	116
Screwdriver	
Air.....	172-173
Insulated Series.....	202
M Series.....	9,129-130
P Series.....	131,202
Pass-Through.....	10,132
Phillips®.....	129,131-132,202
Pistol Handle.....	133
Pozidriv®.....	130
Precision.....	9,132
Ratchet.....	133
Set.....	9,10
Slotted.....	129,131,202
Straight.....	173
Torx®.....	9,130
VDE.....	10
Seal	
Driver Set & Bearing Race.....	237
Pliers.....	216
Service	
Brake, Tool.....	238
Core, Tool.....	229
Serpentine Belt Tool.....	236-237
Shears	
Air Powered.....	168
Angled, Heavy Duty.....	150
Shop	
Light, Rechargeable.....	190
Scissors, Heavy Duty.....	151
Sliding	
Top Roll Cart.....	39
Sliding T-Handles	
3/4".....	71

1/2".....	67
1/4".....	50
3/8".....	58
Sliding Head.....	68
Slip-Joint Pliers.....	114,119,202
Slot and Dots Side Panel.....	36
Socket	
1/4" Drive.....	4,12,14-16,18-20,46-49,52
3/8" Drive.....	4,12,14-16,21-23,55-57,59
1/2" Drive.....	4,12,14-16,24-25,63-66
3/4" Drive.....	72
Bit, 1/4" Drive.....	15,20,48
Bit, 3/8" Drive.....	15,57
Bit, 1/2" Drive.....	15,66
Bit.....	15,20
Bit, Studdy.....	20
Flip Impact.....	71
Impact.....	5,24-25
Insulated.....	199
Lug Nut.....	70
Pass Thru.....	23
SAE.....	20
Set.....	4-5,12,14-16,18-25
Square.....	47
Torx®.....	15,47-48,56-57,65-66
Wrench.....	14,23
Socket Driver	
Flat Tip, 1/4" Drive.....	50
Flat Tip, 3/8" Drive.....	58
Hex, 1/4" Drive.....	48-49
Hex, 3/8" Drive.....	57
Hex, 1/2" Drive.....	67
Phillips®, 1/4" Drive.....	49
Phillips®, 3/8" Drive.....	58
Pozidriv®, 1/4" Drive.....	49
Pozidriv®, 3/8" Drive.....	58
Stubby, 1/4" Drive.....	49
Torx®, 1/4" Drive.....	48
Torx®, 3/8" Drive.....	57
Torx®, 1/2" Drive.....	66
Triple Square 1/4" Drive.....	50
Triple Square 3/8" Drive.....	58
Triple Square 1/2" Drive.....	67
Soft Face Hammers.....	140,142
Speeder	
1/2" Drive.....	68
Wrench.....	104
Spotweld Drill.....	161
Spreader.....	237
Spring Compressor	
Valve Spring.....	239
Spring Tools.....	188,239
Square Drive	
1/4" Drive.....	4,47,50
3/8" Drive.....	4,58
1/2" Drive.....	4
Bits.....	135
Stand, Jack.....	211
Strap, Wrench.....	97,239
Spray, Gun.....	221-222

Spinner Adaptor.....	51
Steel	
Tape	183
Rule	186
Step Drill Set.....	177
Stethoscope.....	195
Strut.....	238
Straightener, Fin & Cleaner.....	229
Striking Tools, & Hammers Set	10
Surface Prep.....	171

T

T-Handle	
Sliding, 1/4" Drive	50
Sliding, 3/8" Drive	58
Sliding, 1/2" Drive	67
Sliding, 3/4" Drive	71
T-Shape Wrenches.....	104
T-Hex Wrenches.....	105
Tamper Resistant	
Bit	135
Bit Socket	48,57,66
Tapes, Measuring.....	183
Terminal	
Brush	235
Tool Kit	196
Test Pen	196
Tester	
Battery	191
Circuit	195
Cooling System Pressure.....	237
Digital Torque	86
Gas/Diesel Combustion Leak.....	196
Thermometer	186
Dial Type	186
Infrared	186
Pocket Digital.....	186
Thread Setter Kits.....	219
Throttle Depressor.....	237
Tie Rod Tools	238
Tin Snips.....	151
Tig Welding Gloves	207
Tire	
Gauge.....	187
Inflator.....	186-187
Tool Bag	42
Tool Box	
Cantilever Style	40
Metal.....	40
Mini.....	40
Plastic.....	41
Toolbox Set	
Insulated.....	198
Socket, Insulated.....	198
Top Chest.....	33-34
Tops, Roll Cab.....	36
Tool Holder, Magnetic	216

Tool Set, Double Flaring.....	228
Tool Storage	27-42
Torque	
Adjustable.....	79-80
COMPUTORQ3.....	84
Digital.....	84,86
Digital Tester	86
Preset.....	80-81
Ratchet	163
Sticks	231
Tester	86
Wrenches	79-81,84
Torx®	
Bits.....	15,48,57,66,135
Bits, Set	134
Bit Socket, 1/4" Drive.....	15,48
Bit Socket, 3/8" Drive.....	57
Bit Socket, 1/2" Drive.....	66
Bit Socket, Sets	15
Driver	48,57,66
Screwdriver.....	9,130
Socket, 1/4" Drive	47-48
Socket, 3/8" Drive	56-57
Socket, 1/2" Drive.....	65-66
Tamper Resistant, Bit	135
Tamper Resistant, Bit Socket.....	48-49,57,66
Wrenches, L-Shape.....	8,106,108
Tote Bag.....	41
Trans Jacks	211
Trays	
Foldable.....	36
Magnetic.....	35
Tread Depth Gauge.....	187
Triple Square Sockets	50,58,67
Tube	
Creeper.....	206
Cutter.....	228
Flaring Set	228
Orifice Tool	229-230
Remover.....	229-230
Titanium Coated Drill Bit Set	177
Tote Bag.....	41
Triangular 2nd-Cut File.....	149
Tweezers Kits	213
Two Post Lift.....	251-252
Tyre Changer.....	247-249

U

U-Clamp, Pliers	122
Universal	
Joint, 1/4" Drive	51
Joint, 3/8" Drive	60,62
Joint, 1/2" Drive	68,70
Joint, 3/4" Drive	72,74
Joint, 1" Drive	76
EFI Quick Probe	195
Valve Core Service Tools.....	230
Radiator Pressure Test Kit	234

Utility	
Knife	152
UV Leak Detection Flashlight Kit	209

V

Vacuum System	240
Vacuum Cleaner	240
Valve	
Adjusting Tools	187
Core	230
Spring Compressor	239
Stem Inserter	230
VDE	
Pliers	8
Screwdriver	10
Velcro, Wool Pad	176
Vinyl Cutter	151
Vise, Bench	222

W

Weld	
Cart	224
Gloves	207
Helmet, Auto Darkening	209
Kit, Standard Duty	224
Sleeves	207
Washable Work Gloves	207
Water Pump Pulley Wrench	97
Wheel	
Aligner	243
Balancer	245-246
Cut Off	175
Flap	175
Grinding	175
Grinding Set	175
Hammer	145
Lock Kit	232
Wire, Crimped	176
Wire, Knotted	176
Windshield Removal Tool	216
Wire	
Brush	176,217
Cutter	214
Stripper	202,214-215
Wheel	176
Wool Velcro Pad	176
Wrenches	87-108
Wrench	
Adjustable	5,6,79-80,91-92,200
Combination	5,7,89-90,98
Composite	156,159
Composite, Grip	92
Compact	158
Chain	97

Click-Type Torque	79-81
Double Flex	94
Double Open End	6,95
Double Ring	6-7,93
Flare Nut	96
Flex Head, Locking	103
Flex Head, Ratcheting	98,101,103
Flex Socket	89
Grip, Composite	92
Grip, Soft	92
Hammer, Single	158
Impact	156,158-159
Insulated	198-201
Interchangeable Head	81
L-Series	80
L-Shape	7,8,71
Mini	156
Oil Filter	235
Open End	6,95,200
Pliers	6
Locking	103
Preset Click-Type	81
Preset Click-Type, Interchangeable Head	81
Ratchet	7
Ratchet Combination	7,98-100
Ratcheting	7,98-99,101,103-104,201
Ratcheting Box	104
Ratcheting, Flex Head	98-99
Ratcheting, Locking Flex Head	103
Ratcheting, Short	101
Ratcheting, Short Flex Head	101
Ring End	93
Sets	5-8,14,23,89-96,98-99,101,103-104,198,235
Soft Grip	92
Single Direction	7
Spanner	229
Speeder	104
Strap	97,235,239
T-Shaped	104
Torx®, Long	8
Torque	79-81
Torque, Digital	84
Water Pump Pulley	97

Showing Millimeter Sizes, Fractional and Decimal Inch Sizes, and Drill Number Sizes

Note: To convert from inches to millimeters, multiply by 25.4; to convert from millimeters to inches, multiply by 0.03937

M	DE	F	DN	M	DE	F	DN	M	DE	F	DN	M	DE	F	DN	M	DE	F	M	DE	F	
0.10	0.0039	—	—	1.85	0.0728	—	—	—	0.1660	—	19	7.25	0.2854	—	—	13.49	0.5313	17/32	35.00	1.3780	—	
0.15	0.0059	—	—	—	0.0730	—	49	4.25	0.1673	—	—	7.30	0.2874	—	—	13.50	0.5315	—	—	36.00	1.4173	—
0.20	0.0079	—	—	1.90	0.0748	—	—	4.30	0.1693	—	—	—	0.2900	—	L	13.89	0.5469	35/64	36.51	1.4375	17/16	
0.25	0.0098	—	—	—	0.0760	—	48	—	0.1695	—	18	7.40	0.2913	—	—	14.00	0.5512	—	37.00	1.4567	—	
0.30	0.0118	—	—	1.95	0.0768	—	—	4.37	0.1719	11/64	—	—	0.2950	—	M	14.29	0.5625	9/16	38.00	1.4961	—	
—	0.0135	—	80	1.98	0.0781	5/64	—	—	0.1730	—	17	7.50	0.2953	—	—	14.50	0.5709	—	—	38.10	1.5000	1 1/2
0.35	0.0138	—	—	—	0.0785	—	47	4.40	0.1732	—	—	7.54	0.2969	19/64	—	14.68	0.5781	37/64	39.00	1.5354	—	
—	0.0145	—	79	2.00	0.0787	—	—	—	0.1770	—	16	7.60	0.2992	—	—	15.00	0.5906	—	39.69	1.5625	19/16	
0.40	0.0156	1/64	—	2.05	0.0807	—	—	4.50	0.1772	—	—	—	0.3020	—	N	15.08	0.5938	19/32	40.00	1.5748	—	
0.40	0.0157	—	—	—	0.0810	—	46	—	0.1800	—	15	7.70	0.3031	—	—	15.48	0.6094	39/64	41.00	1.6142	—	
—	0.0160	—	78	—	0.0820	—	45	4.60	0.1811	—	—	7.75	0.3051	—	—	15.50	0.6102	—	41.28	1.6250	1 5/8	
0.45	0.0177	—	—	2.10	0.0827	—	—	—	0.1820	—	14	7.80	0.3071	—	—	15.88	0.6250	5/8	42.00	1.6535	—	
—	0.0180	—	77	2.15	0.0846	—	—	4.70	0.1850	—	13	7.90	0.3110	—	—	16.00	0.6299	—	42.86	1.6875	1 11/16	
0.50	0.0197	—	—	—	0.0860	—	44	4.75	0.1870	—	—	7.94	0.3125	5/16	—	16.27	0.6406	41/64	43.00	1.6929	—	
—	0.0200	—	76	2.20	0.0866	—	—	4.76	0.1875	3/16	—	7.80	0.3150	—	—	16.50	0.6496	—	44.00	1.7323	—	
—	0.0210	—	75	2.25	0.0886	—	—	4.80	0.1890	—	12	—	0.3160	—	O	16.67	0.6563	21/32	44.45	1.7500	1 3/4	
0.55	0.0217	—	—	—	0.0890	—	43	—	0.1910	—	11	8.10	0.3189	—	—	17.00	0.6693	—	45.00	1.7717	—	
—	0.0225	—	74	2.30	0.0906	—	—	4.90	0.1929	—	—	8.20	0.3228	—	—	17.07	0.6719	43/64	46.00	1.8110	—	
0.60	0.0236	—	—	2.35	0.0925	—	—	—	0.1935	—	10	—	0.3230	—	P	17.46	0.6875	11/16	46.04	1.8125	1 13/16	
—	0.0240	—	73	—	0.0935	—	42	—	0.1960	—	9	8.25	0.3248	—	—	17.50	0.6890	—	47.00	1.8504	—	
—	0.0250	—	72	2.38	0.0938	3/32	—	5.00	0.1969	—	—	8.30	0.3268	—	—	17.86	0.7031	45/64	47.63	1.8750	1 7/8	
0.65	0.0256	—	—	2.40	0.0945	—	—	—	0.1990	—	8	8.33	0.3281	21/64	—	18.00	0.7087	—	48.00	1.8898	—	
—	0.0260	—	71	—	0.0960	—	41	5.10	0.2008	—	—	8.40	0.3307	—	—	18.26	0.7188	23/32	49.00	1.9291	—	
0.70	0.0276	—	—	2.45	0.0965	—	—	—	0.2010	—	7	—	0.3320	—	Q	18.50	0.7283	—	49.21	1.9375	1 15/16	
—	0.0280	—	70	—	0.0980	—	40	5.16	0.2031	13/64	—	8.50	0.3346	—	—	18.65	0.7344	47/64	50.00	1.9685	—	
—	0.0292	—	69	2.50	0.0984	—	—	—	0.2040	—	6	8.60	0.3386	—	—	19.00	0.7480	—	50.80	2.0000	2	
0.75	0.0295	—	—	—	0.0995	—	39	5.20	0.2047	—	—	—	0.3390	—	R	19.05	0.7500	3/4	51.00	2.0079	—	
—	0.0310	—	68	—	0.1015	—	38	—	0.2055	—	5	8.70	0.3425	—	—	19.45	0.7656	49/64	52.00	2.0472	—	
0.79	0.0313	1/32	—	2.60	0.1024	—	—	5.25	0.2067	—	—	8.73	0.3438	11/32	—	19.50	0.7677	—	52.39	2.0625	2 1/16	
0.80	0.0315	—	—	—	0.1040	—	37	5.30	0.2087	—	—	8.75	0.3445	—	—	19.84	0.7813	25/32	53.00	2.086	—	
—	0.0320	—	67	2.70	0.1063	—	—	—	0.2090	—	4	8.80	0.3465	—	—	20.00	0.7874	—	53.98	2.1250	2 1/8	
—	0.0330	—	66	—	0.1065	—	36	5.40	0.2126	—	—	—	0.3480	—	S	20.24	0.7969	51/64	54.00	2.1260	—	
0.85	0.0335	—	—	2.75	0.1083	—	—	—	0.2130	—	3	8.90	0.3504	—	—	20.50	0.8071	—	55.00	2.1654	—	
—	0.0350	—	65	2.78	0.1094	7/64	—	5.50	0.2165	—	—	9.00	0.3543	—	—	20.64	0.8125	13/16	55.56	2.1875	2 3/16	
0.90	0.0354	—	—	—	0.1100	—	35	5.56	0.2188	7/32	—	—	0.3580	—	T	21.00	0.8268	—	56.00	2.2047	—	
—	0.0360	—	64	2.80	0.1102	—	—	5.60	0.2205	—	—	9.10	0.3583	—	—	21.03	0.8281	53/64	57.00	2.2441	—	
—	0.0370	—	63	—	0.1110	—	34	—	0.2210	—	2	9.13	0.3594	23/64	—	21.43	0.8438	27/32	57.15	2.2500	2 1/4	
0.95	0.0374	—	—	—	0.1130	—	33	5.70	0.2244	—	—	9.20	0.3622	—	—	21.50	0.8465	—	58.00	2.2835	—	
—	0.0380	—	62	2.90	0.1142	—	—	5.75	0.2264	—	—	9.25	0.3641	—	—	21.83	0.8594	55/64	58.74	2.3125	2 5/16	
—	0.0390	—	61	—	0.1160	—	32	—	0.2280	—	1	9.30	0.3661	—	—	22.00	0.8661	—	59.00	2.3228	—	
1.00	0.0394	—	—	3.00	0.1181	—	31	5.80	0.2283	—	—	—	0.3680	—	U	22.23	0.8750	7/8	60.00	2.3622	—	
—	0.0400	—	60	—	0.1200	—	—	5.90	0.2323	—	—	9.40	0.3701	—	—	22.50	0.8858	—	60.33	2.3750	2 3/8	
—	0.0410	—	59	3.10	0.1220	—	—	—	0.2340	—	A	9.50	0.3740	—	—	22.62	0.8906	57/64	61.00	2.4016	—	
1.05	0.0413	—	—	3.18	0.1250	1/8	—	5.95	0.2344	15/64	—	9.53	0.3750	3/8	—	23.00	0.9055	—	61.91	2.4375	2 7/16	
—	0.0420	—	58	3.20	0.1260	—	—	6.00	0.2362	—	—	—	0.3770	—	V	23.02	0.9063	29/32	62.00	2.4409	—	
—	0.0430	—	57	3.25	0.1280	—	30	—	0.2380	—	B	9.60	0.3780	—	—	23.42	0.9219	59/64	63.00	2.4803	—	
1.10	0.0433	—	—	—	0.1285	—	—	6.10	0.2402	—	—	9.70	0.3819	—	—	23.50	0.9252	—	63.50	2.5000	2 1/2	
1.15	0.0453	—	—	3.30	0.1299	—	—	—	0.2420	—	C	9.75	0.3838	—	—	23.81	0.9375	15/16	64.00	2.5197	—	
—	0.0465	—	56	3.40	0.1339	—	—	6.20	0.2441	—	—	9.80	0.3858	—	—	24.00	0.9449	—	65.00	2.5591	—	
1.19	0.0469	3/64	—	—	0.1360	—	29	6.25	0.2460	—	D	—	0.3860	—	W	24.21	0.9531	61/64	65.09	2.5625	2 9/16	
1.20	0.0472	—	—	3.50	0.1378	—	—	6.30	0.2480	—	—	9.90	0.3898	—	—	24.50	0.9646	—	66.00	2.5984	—	
1.25	0.0492	—	—	—	0.1405	—	28	6.35	0.2500	1/4	E	9.92	0.3906	5/64	—	24.61	0.9688	31/32	66.68	2.6250	2 5/8	
1.30	0.0512	—	—	3.57	0.1406	9/64	—	6.40	0.2520	—	—	10.00	0.3937	—	—	25.00	0.9843	—	67.00	2.6378	—	
—	0.0520	—	55	3.60	0.1417	—	—	6.50	0.2559	—	—	—	0.3970	—	X	25.00	0.9844	63/64	68.00	2.6772	—	
1.35	0.0531	—	—	—	0.1440	—	27	—	0.2570	—	F	—	0.4040	—	Y	25.40	1.0000	1	68.26	2.6875	2 11/16	
—	0.0550	—	54	3.70	0.1457	—	—	6.60	0.2598	—	—	10.32	0.4063	3/32	—	26.00	1.0236	—	69.00	2.7165	—	
1.40	0.0551	—	—	—	0.1470	—	26	—	0.2610	—	G	—	0.4130	—	Z	26.99	1.0625	1 1/16	69.85	2.7500	2 3/4	
1.45	0.0571	—	—	3.75	0.1476	—	—	6.70	0.2638	—	—	10.50	0.4134	—	—	27.00	1.0630	—	70.00	2.7559	—	
1.50	0.0591	—	—	—	0.1495	—	25	6.75	0.2656	17/64	—	10.72	0.4219	27/64	—	28.00	1.1024	—	71.00	2.7953	—	
—	0.0595	—	53	3.80	0.1496	—	—	6.75	0.2657	—	—	11.00	0.4331	—	—	28.58	1.1250	1 1/8	71.44	2.8125	2 13/16	
1.55	0.0610	—	—	—	0.1520	—	24	—	0.2660	—	H	11.11	0.4375	7/16	—	29.00	1.1417	—	72.00	2.8346	—	
1.59	0.0625	1/16	—	3.90	0.1535	—	—	6.80	0.2677	—	—	11.50	0.4528	—	—	30.00	1.1811	—	73.00	2.8740	—	
1.60	0.0630	—	—	—	0.1540	—	23	6.90	0.2717	—	—	11.51	0.4531	29/64	—	30.16	1.1875	1 3/16	73.03	2.8750	2 7/8	
—	0.0635	—	52	3.97	0.1563	5/32	—	—	0.2720	—	I	11.91	0.4688	15/32	—	31						

Snap-on Asia Pacific Division, or its assigns, ("Snap-on") warrants to customers who purchase products from authorized Blue-Point distribution channels that Blue-Point® brand products will be free from defects in workmanship and materials for a duration depending upon the nature of the product. Prior to a product purchase, customer can obtain the product warranty duration from a Blue-Point reseller. Customers may also contact the closest sales office as listed below.

During the applicable duration of the warranty, at its option, Snap-on will repair or replace its products which fail to give satisfactory service due to defective workmanship or materials, or provide a refund by repaying or crediting customer with an amount equal to the purchase price of such products. Repair, replacement or refund shall be at the election and expense of Snap-on, and is customer's exclusive remedy in place of all other rights and remedies. Any products or parts replaced or for which Snap-on has provided a refund are the property of Snap-on and will not be returned.

THE FOREGOING WARRANTY IS IN LIEU OF AND EXCLUDES ALL OTHER WARRANTIES NOT EXPRESSLY SET FORTH HEREIN, WHETHER EXPRESS, IMPLIED OR COLLATERAL, BY OPERATION OF LAW OR OTHERWISE, INCLUDING BUT NOT LIMITED TO ANY IMPLIED WARRANTIES OF MERCHANTABILITY OR FITNESS FOR A PARTICULAR PURPOSE. Descriptions of product contained in this catalog are for the sole purpose of identifying product and shall not be construed as an express warranty.

LIMITATION OF LIABILITY. SNAP-ON AND ITS AFFILIATED COMPANIES AND THIRD PARTY SUPPLIERS SHALL NOT BE LIABLE FOR ANY INCIDENTAL, SPECIAL OR CONSEQUENTIAL LOSSES, COSTS OR DAMAGES INCURRED BY CUSTOMER OR OTHERS, INCLUDING PERSONAL INJURY OR DEATH, DIRECTLY OR INDIRECTLY ARISING FROM THE SALE, HANDLING OR USE OF THE PRODUCTS, OR FROM ANY OTHER CAUSE WITH RESPECT TO THE PRODUCTS OR THE FOREGOING WARRANTY, WHETHER SUCH CLAIM IS BASED UPON BREACH OF CONTRACT, BREACH OF WARRANTY, STRICT LIABILITY IN TORT, NEGLIGENCE OR ANY OTHER LEGAL THEORY (INCLUDING WITHOUT LIMITATION, LOST PROFITS, REVENUES, ANTICIPATED SALES, BUSINESS OPPORTUNITIES, GOODWILL, OR INTERRUPTION OF BUSINESS OR OTHER INJURY OR DAMAGE).

Snap-on® and Blue-Point® are registered trademarks of Snap-on Incorporated

SNAP-ON ASIA PACIFIC OFFICES

Asia / Pacific Division

25 Tagore Lane, #01-02
Singapore 787602
Tel: +(65) 6459-2712
Fax: +(65) 6459-1520

Snap-on Trading (Shanghai) Co., Ltd.

Unit 2001-2005, Cross Tower
318 Fuzhou Road, Shanghai 200001
P.R.China
Tel: +(86-21) 6391-2388
Fax: +(86-21) 6391-2382

Snap-on Trading (Shanghai) Co., Ltd. Beijing Branch

517B, Grand Pacific Building
8A Guanghua Road
Beijing 100026
P.R.China
Tel: +(86-10) 6581-8838
Fax: +(86-10) 6581-6681

Snap-on Tools India Private Ltd.

6/2, Begumpur Khatola,
39 Milestone, NH-8, Gurgaon,
Haryana-122004, India
Tel: +(91-124) 459-9700
Fax: +(91-124) 405-6866

Snap-on Tools Japan, K.K.

2-1-6 Shinkiba, Koto-ku,
Tokyo, 136-0082 Japan
Tel: +(81-3) 5534-1285
Fax: +(81-3) 5534-1284

Snap-on Tools Hong Kong Ltd.

Unit 2010, 20/F, Laford Centre,
838 Lai Chi Kok Road,
Cheung Sha Wan, Kowloon
Hong Kong
Tel: +(852) 2370-3700
Fax: +(852) 2370-3400

Snap-on Tools Korea Ltd.

#505, Building 301,
Bucheon Techno Park Block 3
365 SamJung-Dong,
OhJung-Gu, Bucheon City
GyeongGi-Do 421-809, Korea
Tel: +(82-32) 326-7310
Fax: +(82-32) 326-7312

Snap-on Tools Singapore Pte. Ltd.

25 Tagore Lane, #01-01
Singapore 787602
Tel: +(65) 6451-5570
Fax: +(65) 6451-5574

Snap-on Tools Singapore Pte. Ltd. (Representative Office)

Graha Pratama Building, 14th Floor
Jl. M. T. Haryono Kav.15,
Jakarta 12810, Indonesia
Tel: +(62-21) 8370-9611
Fax: +(62-21) 8370-9612

Snap-on Tools Singapore Pte. Ltd. Malaysia Branch

B-6-10, Street Mall, One South
Jalan OS, Taman Serdang Perdana
43300 Seri Kembangan, Selangor
Malaysia
Tel: +(603) 8957-1938
Fax: +(603) 8957-2938

Snap-on Tools Singapore Pte. Ltd. Philippines Branch

Unit 801 Prime Land, Market St.,
Madrigal Business Park,
Ayala Alabang, Muntinlupa City,
1781 Philippines
Tel: +(63-2) 843-7935
Fax: +(63-2) 843-7730

Snap-on Tools Singapore Pte. Ltd. Taiwan Branch

3F-4, #9 Wuquan 1st Road,
New Taipei Industrial Park,
Xinzhuang District 24892,
New Taipei City, Taiwan ROC
Tel: +(886-2) 2298-9789
Fax: +(886-2) 2298-2288

Snap-on Tools Singapore Pte. Ltd. Vietnam Branch

Suite 1726, Level 17 CJ Building,
2Bis-4-6 Le Thanh Ton Street,
Ben Nghe Ward, District 1,
Ho Chi Minh City, Vietnam
Tel: +(84-8) 6255-6763
Fax: +(84-8) 6255-68018

Snap-on (Thailand) Co., Ltd.

Talomsin Building, 924, Rama 3 Road
Bangpongpang Yannawa,
Bangkok 10120, Thailand
Tel: +(66) 2294-9660
Fax: +(66) 2294-9665